



ACER INCORPORATED

2022
SUSTAINABILITY REPORT

2
0
2
2

Reuse, recycle for a sustainable future

Cover Story: Reuse, recycle for a sustainable future

Plastic trash is a serious environmental problem that affects millions of people and animals around the world. It originates from various plastic sources, some remain in landfills or end up as ocean trash, some break down into tiny fragments and enter the soil, water, and air, and can be ingested by animals and humans.

For Acer, the most efficient way to reduce plastic trash and its negative impacts is to use PCR (post-consumer recycled) plastic on our products and replace virgin plastic usage. PCR plastic is made from plastic trash that is collected and recycled through various recycling channels. By using PCR plastic, we can save energy, reduce greenhouse gas emissions, conserve natural resources, and divert waste from landfills and oceans.

Various problems caused by plastic trash include:

- Clogging the digestive systems of marine animals and birds, leading to starvation, suffocation, or infection.
- Accumulating in the tissues and organs of animals and humans, causing inflammation, toxicity, or hormonal disruption.
- Transporting harmful chemicals or pathogens that can contaminate the food chain or water sources.
- Reducing the quality and availability of natural resources, such as water, soil, or biodiversity.



Acer has set a clear goal to reach 20-30% in total PCR plastic usage by 2025. In order to reach the goal, our strategy is to increase PCR plastic percentage step by step, to apply PCR plastic on more parts, and on more products. For example, we applied 30% PCR plastic on the Aspire Vero laptop chassis in 2022, which is increased to 40% in 2023 while still meeting our quality requirement. Aside from the chassis, we have looked into other possible places and applied 50% PCR plastic on keyboard caps and 100% Ocean-Bound Plastic (OBP) on the touchpad.

Beyond the product itself, we also applied 50% PCR plastic on the power adaptor. This is one example showing our progress of PCR plastic usage, and this strategy is also applied on all product lines, including desktops, monitors, projector, gadgets, routers and even the Acerpure air purifier..

Sustainability on product design is a continuous way to improve, we are proud of what we have done and what we are working on, for a better planet.

In this report, you can learn more about the application of PCR Plastics in the following chapters: [Chapter 5 Circular Economy and Innovation](#).



2022 Highlights

30million

Over 30 million units used post-consumer recycled plastics (2020-2022)

17%

In 2022, 17% of PCR plastic content in computers and displays

20 - 30%

20-30% PCR plastic content in computers and displays by 2025

Contents

Cover Story	02	02 ESG Governance and Strategy	15	04 Responsible Supply Chain	70	07 Inclusive Workplace and Society	116
Message from the Chairman and CEO	05	UN Sustainable Development Goals (SDGs)	16	Supply Chain Management Mechanisms	73	Human Rights Protection	118
Important Achievements and Recognition	07	ESG Governance and 2025 Sustainability Goals	19	Supply Chain Social Management	76	Attracting and Developing Talent	125
ESG Performance Highlights	08	Sustainable Value	22	Supply Chain Environmental Management: Supply Chain Climate Engagement	79	Health and Safety in the Workplace	142
		Materiality and Stakeholder Engagement	23	Supply Chain Audit and Improvement	81	Digital Inclusion and Social Philanthropy	148
01 About Acer	09	03 Operations and Governance	37	05 Circular Economies and Innovation	85	08 Summary of ESG Information	157
About the Company	10	Corporate Governance	38	Acer's Model of Circular Economies	86	Summary of ESG Information	157
Status of Operations	12	Risk Management	46	Product Life Cycle	89		
Brand Values	13	Information Security and Privacy Protection	51	Innovative Products and Services	96	09 Appendix	160
		Customer Service	58			About this Report	160
		Operations and Environment	63	06 Climate Strategy and Transformation	106	GRI Standards Indicators	161
				Blueprint for Low-carbon Transition and Climate Strategy	108	SASB Standards	171
				Climate Risks and Opportunities and Climate-Related Financial Disclosures (TCFD)	111	Disclosure of Sustainability Indicators by Listed Companies	173
				Greenhouse Gas Emissions	112	United Nations Global Compact Comparison Table	174
				Our Climate Actions	114	Independent Limited Assurance Report	175



Message from the Chairman and CEO

Throughout 2022 Acer has kept evolving with changing lifestyles, focusing on maintaining its business momentum. In a year filled with economic challenges and environmental concerns, we asked Acer Chairman and CEO Jason Chen how the company managed the impacts on its operations and key steps taken for the environment and society.

What were the key economic impacts felt by Acer during 2022?

I'd like to start by highlighting that we have centered our efforts on optimizing inventory levels with the right portfolio of goods, optimizing operating expenditure and increasing net cash to enhance operational sustainability. While multiple industries have faced challenges stemming from inflation, geopolitical issues, and lingering impacts of the Covid-19 pandemic, the PC industry has entered a period of correction.

How has Acer managed these impacts?

As we keep evolving with changing lifestyles and adjusting strategies dynamically for business needs, we are also focusing on maintaining business momentum and marching toward a more sustainable future. Throughout 2022, in addition to launching various innovative computer and display products, we expanded our Vero portfolio made with recycled materials, and significantly grew our numerous businesses other than computers and displays.

We have shaped a company culture driven by innovation and intrapreneurship, and we are confident that new technologies will trigger new usage models and stimulate market demand over time. In Q4 2022, businesses other than computers and displays contributed 26.3% of total consolidated revenues of Acer Inc. In addition, we own patents in the AI medical field and 300+ patents in thermal cooling technology, and rank No. 2 for patent applications in Taiwan. For the world-renowned iF Design Awards, Acer holds the titles of "Top 50 (of 7128) Companies" worldwide during 2018-2022.

How are the non-PC and display businesses as part of your multiple growth engines doing?

Also known as "new initiatives" these growth engines complement our existing computer and display business. The common objective shared by our initiatives and existing businesses is to explore new markets and broaden current boundaries, and ultimately to optimize operations, reach profitability, and contribute to Acer group's sustainability.

Currently, we have subsidiaries in diverse scopes of business, including beverage, system integration, EV charging stations, gaming, apparel, home appliances, AI-assisted medical solutions, e-mobility, smart cities, cyber security, cloud solutions, and more. Our strategy to promote intrapreneurship by building multiple business engines continued to gain momentum with nine public subsidiaries by December 2022. There are also several businesses under incubation, such as for servers and home appliances that continue to show strong progress. Meanwhile, to ensure our shareholders have their share of voice in our business development, we offer them the opportunity to invest in these new engines as they go public, thereby also ensuring our adherence to corporate governance.

Is there something new and upcoming from Acer that you'd like to share with your stakeholders?

Yes, in 2023 we plan to publish our TCFD (Climate-related Financial Disclosure) separately from our corporate sustainability report. TCFD is an important framework providing companies with risk management and decision-making planning. As climate change is today a critical topic, the individual report allows us to disclose our plans in detail for our stakeholders to better understand the related financial impact and demonstrates our determination to tackle climate change.

What key progress has been made on exerting your influence to inspire others to join efforts on addressing environmental and social issues?

First of all, we are committed to reaching net zero emissions by 2050 starting from three major aspects: operations, products and services, and value chain, and we will continue to work toward the goals of using 20-30% post-consumer recycled (PCR) plastic in our computers and displays by 2025 and sourcing 100% renewable electricity by 2035 for the Acer Group, for which we have reached 17% and 44% respectively in 2022. Since launching our eco-conscious Vero laptop that utilizes recycled plastic, recyclable packaging, and ocean-bound plastic, the line has expanded to desktops, monitors, displays, all-in-ones, Chromebooks, and even accessories. Acer's Vero portfolio offers consumers, businesses, and organizations more options to reduce their carbon footprint and join our advocate for circular economies.

Secondly, our "Earthion" sustainability platform that unites employees and supply chain partners to tackle environmental challenges continues to gain in strength. We held a "21-Day Green Challenge" for which over 7,000 employees of Acer, our partners, and suppliers were motivated to reduce their carbon footprint. The campaign succeeded in raising awareness for environmental protection, helped employees form "green" habits, and cut an equivalent of 152 tons CO₂ emissions.

Thirdly, we continued to respond to the United Nations Sustainable Development Goals (SDGs) with our existing businesses and new initiatives. For example, our AI-assisted medical solutions, including diabetic retinopathy diagnosis software, responds to SDG 3 for good health and well-being; we provide rainfall and flood control water storage systems that answer to SDG 11 for sustainable cities and communities; and our Vero devices respond to SDG 12 for responsible consumption and production as well as SDG 13 for climate action.

Last but not least, we donated laptops and tablets to replace computer science lab equipment at a school in Ukraine, in support of their goal to enhance student learning. Acer is committed to contributing toward social responsibilities for which education is one of our key focuses. As a global technology company, Acer seeks to promote digital equity, and break the barriers between people and technology. For this, we are pleased to be named among the World Benchmarking Alliance's 2,000 most influential companies on meeting the United Nations SDGs, in the field of digital inclusion.

ESG is a hot topic for almost every company, if you could, how would you rate your efforts?

Acer's focus on environmental, social and governance (ESG) through transparent reporting and initiatives under our Earthion mission has gained increasing global recognition. We believe they have been instrumental in our growing inclusion in worldwide sustainability indices throughout 2022, and that third parties' score cards are a testament that our efforts are making a difference.

For the third straight year, Acer has been named in the Top 5% category of the S&P Global Sustainability Yearbook for sustainable business practices. For the ninth consecutive year, we have been a constituent of the MSCI ESG Leaders Indexes – garnering the best rating of "AAA" in our category – and listed on the Dow Jones Sustainability Indices (DJSI) Emerging Markets. For the first time, we were awarded Platinum medal that represents EcoVadis Sustainability Rating's highest recognition representing the top 1% of rated companies. We were also listed on the FTSE4Good Emerging Index for the seventh year.

Moreover, Acer was included in Forbes' list of the World's Best Employers and the World's Top Women-Friendly Companies in 2022.

Chairman and CEO, Acer Inc.

Jason Chen



Important Achievements and Recognition



MSCI ESG Leaders Indexes

Selected for MSCI Leaders Indexes for the ninth consecutive year



MSCI ESG Rating

AAA

Member of
Dow Jones Sustainability Indices
Powered by the S&P Global CSA

The Dow Jones Sustainability Emerging Markets Index

Listed for nine year and achieved its best ranking No.2 in THQ Computers & Peripherals and Office Electronics category



S&P Global Sustainability Year Book

Received top 5% of companies in the S&P Global Sustainability Yearbook 2023



FTSE4Good

Selected for inclusion in the FTSE4Good Emerging Index for the seventh consecutive year



FTSE4Good
TIP Taiwan ESG Index



FTSE4Good TIP Taiwan ESG Index

Selected for the fifth consecutive year to join the FTSE4Good TIP Taiwan ESG Index



Ecovadis Sustainability Rating

Received Platinum



Taiwan Corporate Sustainability Awards (TCSA)

Received Platinum of Sustainability Report Award in the TCSA



ISS ESG

Rated "Prime" of ESG Corporate Rating



World Benchmarking Alliance (WBA)

Included in the list of the 2,000 most influential companies (SDG2000)
Ranked 64th of Digital Inclusion benchmarking



World's Best Employer by Forbes

Named by Forbes as one of the World's Best Employers for the third straight year and joining the ranks as one of America's Best Employers for New Grads in 2022



World's Top Female Friendly Companies

Included in Forbes' List of the World's Top Women-Friendly Companies in 2022

ESG Performance Highlights

Environment



44%

44% renewable electricity by Acer Group

30 million

Over 30 million units used post consumer recycled plastics (2020-2022)

60%

60% of critical suppliers committed to RE100 or set SBT Carbon reduction target

Leader-ship Level

Rated a leadership level A- from the CDP climate change for 2 consecutive years

Social



100%

100% of 3TG smelters conformant to participated in third-party mechanisms for OECD Due Diligence Guidance

Digital Inclusion

Ranked 64th in the world benchmarking alliance's Digital Inclusion Category

Third year

Ranked among the world's best companies to work for third year in a row by leading financial magazine Forbes

11,554

Acer global investment in regional social projects totals over 11,554 man-hours

Governance & Economics



Second

Ranked No. 2 for patent applications in Taiwan.

41%

Vero portfolio Q4'22 revenues up 41.3% QoQ

MDR

Global introduction of MDR (Managed detection and response) threat detection response and compliance detection defense mechanism to significantly strengthen global information security defense capabilities

95%

Percentage of positive customer evaluations reached 95%

01

ABOUT ACER

For the long-term sustainability of both Acer’s operations and the environment, Acer continues to evolve with industry and lifestyle changes by pushing for innovation in existing businesses with eco-conscious solutions, while expanding multiple business engines. Guided by its long-term mission of breaking barriers between people and technology, Acer determines to change the world for the better, and aligns with the company’s commitment to environmental, social, and governance.

- **About the Company** 56
- **Status of Operations** 58
- **Brand Values** 60



The Aspire Vero laptop has been awarded with the 2022 iF Design Award and 2022 Red Dot award, and was selected as Sustainability Product of the Year from Business Intelligence Group.

PROJECT HUMANITY

The Project Humanity campaign won a Shorty Impact Award in the “Best in Employee Engagement” category

71%

71% of Acer global employees joined in “21-Day Challenge”

About the company

Founded in 1976, Acer is one of the world's top ICT companies with a presence in more than 160 countries. As Acer evolves with the industry and changing lifestyles, it is focused on enabling a world where hardware, software and services will fuse with one another, creating ecosystems and opening up new possibilities for consumers and businesses alike. Acer's 7,700 employees are dedicated to the research, design, marketing, sale, and support of products and solutions that break barriers between people and technology. The company's strategy to enhance its resilience through establishing multiple business engines has resulted in establishing nine public subsidiaries in Taiwan by the end of 2022.



Founded
1976

Headquarters
Taiwan

Employees
7,700+

Retail touchpoints
95,000

Products sold in
160+ countries

Highlights

9

9 listed companies (Up 50% YoY): Including Weblink, ACSI, AEB, Aopen, Acer Medical, Highpoint Service Network, AST, Acer Gaming, Acer Gadget

78.3%

2022 revenues: 78.3% from computers + displays; 21.7% from other businesses (11.9% growth YoY)

100%

Pledged to source 100% renewable electricity by 2035

41.3%

Vero portfolio Q4'22 revenues up 41.3% QoQ

RANK
2

Ranked No. 2 in patent applications in Taiwan, 2022

| Business Scope

Acer has continued to innovate in existing businesses and new initiatives to secure long-term sustainability and growth. In the computers and displays business, Acer is committed to strengthening the foundations with technological innovations by designing product lines that meet the specific needs of gamers, creators, education, vertical markets, and more. For initiatives other than PCs and displays, Acer has invested in multiple business engines, including beverage, apparel, home appliances, AI-assisted medical solutions, e-mobility, smart cities, information security, and more.

With a firm commitment to sustainability, Acer's "Earthion" platform reflects the milestones it sets for the environment and humanity. The growing number of sustainability-focused Vero PCs, displays, and gadgets further strengthens the connection between technology and humanity and demonstrates the commitment of Acer and its supply-chain partners to bring positive impacts on the environment.

Current Products and Services



- | | |
|--------------------|--------------------------------------|
| Notebook Computers | Gaming products and esports platform |
| Desktop Computers | Gadgets and apparel |
| Monitors | E-business and services |
| Projectors | Commercial solutions |
| Servers | Digital signage solutions |
| Cloud services | Cyber security and datacenter |
| Beverages | AI-assisted medical solutions |
| Smart cities | Home appliances |
| E-mobility | |

Organization Chart

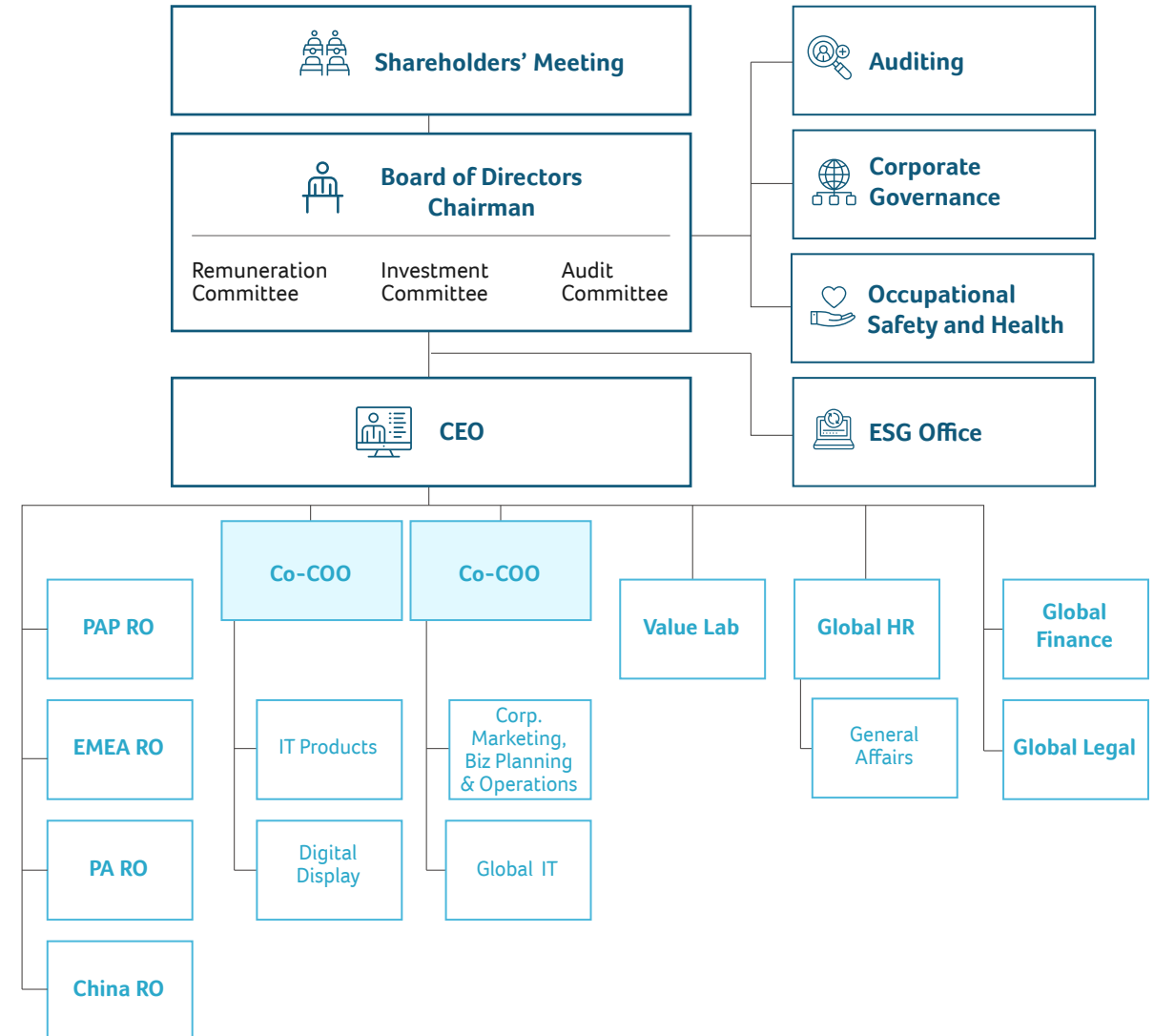

Status of Operations

According to data from global technological research and consulting firm, Gartner, the global PC market in 2022 declined 16.2% year-on-year. Gartner also said that in Q4 2022, the anticipation of a global recession, increased inflation and higher interest rates had a major impact on PC demand. During this time of high economic uncertainty and volatility, Acer took the strategy of optimizing inventory levels, and concluded the full year 2022 ranked No. 6 among top PC brands with 6.1% market share.

Throughout 2022 Acer's business was affected by supply-chain disruptions due to geo-political issues alongside impacts of the Covid-19 pandemic, thus, the company management team already expected lower revenues from its computers and displays business, compared to 2021. In parallel, Acer's strategy to strengthen its multiple business engines, and ultimately enhance overall resilience, continued gaining momentum with businesses other than computers and displays contributing 21.7% of total revenues in 2022. In addition, its Vero line of eco-conscious computers were well received by consumers with increasing demand.

For the full year 2022, Acer reported consolidated revenues of NT\$275.42 billion, gross profits of NT\$29.74 billion with 10.8% margin, operating income of NT\$6.93 billion, net income of NT\$5 billion, and EPS of NT\$1.67.

Financial Performance

Consolidated Revenue

(Unit: NTD Billion)

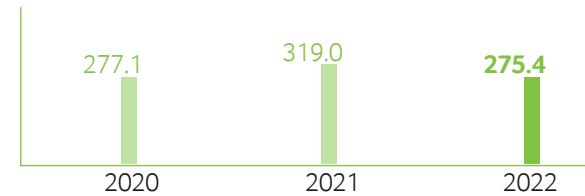

Operation Profit (Loss)

(Unit: NTD Billion)

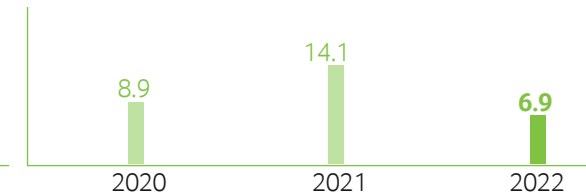

After Tax Earnings (Loss)

(Unit: NTD Billion)

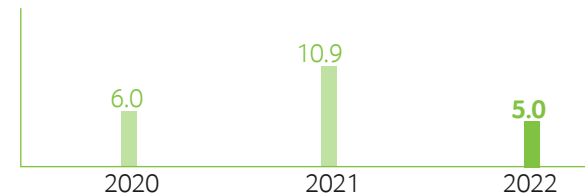

Dividends and Basic Earnings Per Share

(Unit: NTD)

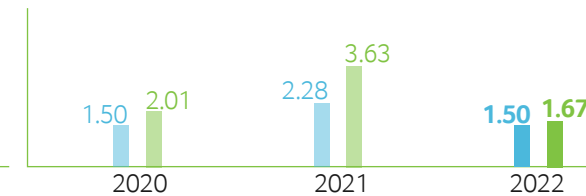

Distribution of Economic Value

Operation Expenses/ Staff Remuneration and Welfare

(Unit: NTD Billion)

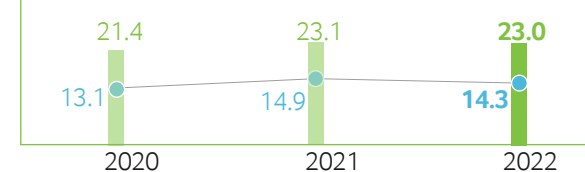

■ Operation Expenses ● Staff Remuneration and Welfare

Liabilities and Equity

(Unit: NTD Billion)

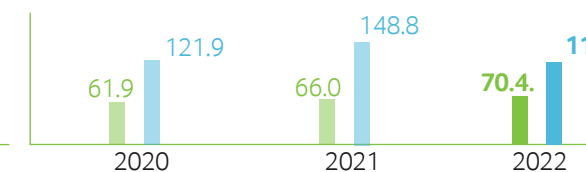

■ Equity ■ Liabilities

Income Tax Expense (Benefits)

(Unit: NTD Billion)

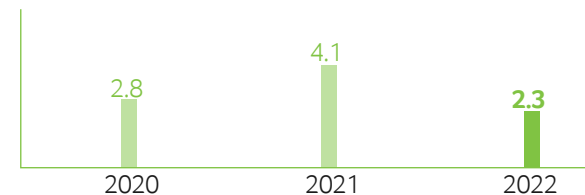

R&D

(Unit: NTD Billion)

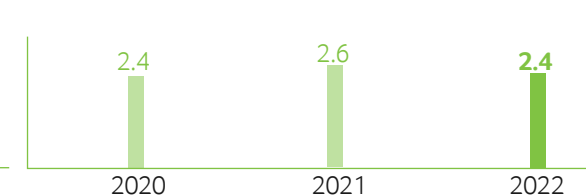

IT Products 2022

Unit: NT\$ (Million)

Region

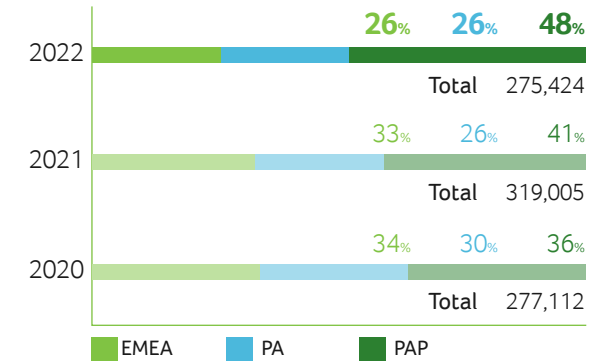

Product Category

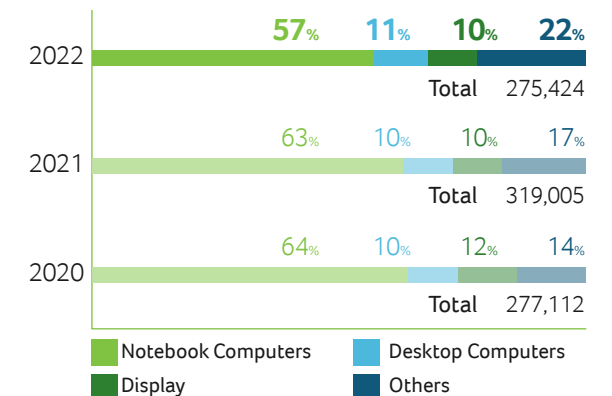

Brand Values

For the long-term sustainability of both Acer’s operations and the environment, Acer continues to evolve with industry and lifestyle changes by pushing for innovation in existing businesses with eco-conscious solutions, while expanding multiple business engines. Guided by its long-term mission of breaking barriers between people and technology. Acer’s brand values of “human,” “progressive” and “curious” translate into a determination to change the world for the better, and aligns with the company’s commitment to environmental, social, and governance.

| Acer Earthion for Sustainability

An advocate for circular economies, Acer has called for more businesses to join its Earthion platform and push for environmentally friendly designs and processes. “Earthion” is a blend of the words “Earth + Mission,” a name created to represent Acer’s mission to help tackle environmental challenges through collaboration with its employees and supply chain partners.

Since launching in 2021, the Vero line of eco-conscious products has expanded from laptops to desktops, monitors, projectors, and accessories, which utilize recycled plastic, recyclable packaging, or ocean-bound plastic. The Vero line offers consumers, businesses, and organizations more options to reduce their carbon footprint.

To combat manufacturing’s impact on the climate, Acer stepped up with its partners to upgrade the overall waste management system with particular emphasis on plastic reduction and chemical surveillance. From reducing plastic bag usage in production lines to bringing sustainable changes to suppliers’ manufacturing system, Acer works hand-in-hand with its partners and suppliers.

Earthion’s primary topics of focus include Acer’s RE100 commitment to source 100% renewable electricity by 2035, the pursuit of greener product design, and to reduce the carbon footprint of Acer’s supply chain.



Through our green innovations and initiatives, we continue to move forward with humanity in mind, step by step, project by project, and mission by mission.

Jason Chen, Chairman and CEO, Acer



Green Challenge

In August 2022, Acer held an eco-conscious campaign to motivate its employees, partners, and suppliers to reduce carbon footprints during a “21-Day Challenge^{Note1}.” 71% of Acer employees and over 2,000 partner employees took part, totaling more than 7,000 people worldwide, cutting an estimated 152,491 kg of CO₂ emissions or the equivalent of CO₂ absorbed by 15,249^{Note2} grown trees in one year. The campaign leveraged Acer’s ability to bring together the strengths of its supply chain partners, which contributed to a total of 154,042 “green actions” recorded during the challenge. Among Acer employees alone, one action was completed approximately every 30 seconds.

Note1: The actual period varied in different regions due to logistical reasons

Note2: Based on a conservative estimate that an average grown tree will absorb approximately 10kg of CO₂ per year – One Tree Planted

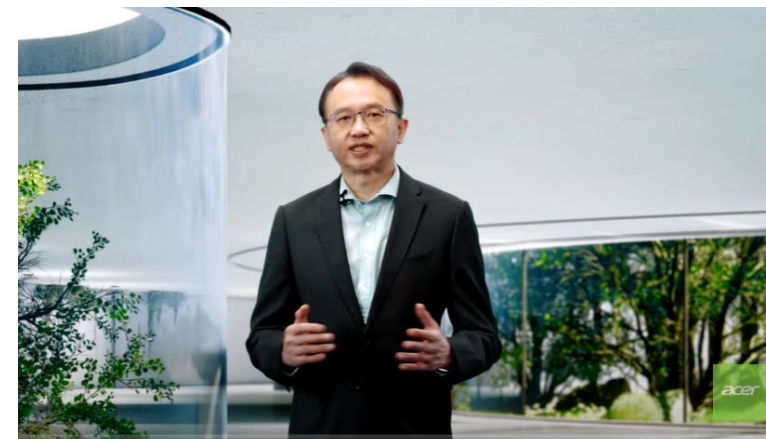

“It is said that it takes 21 days to develop a habit, this was the idea behind our 21-Day Challenge. This tremendous result demonstrates the impact of our Earthion mission; besides our amazing employees who took part, I want to express my gratitude to more than 2000 participants from our business partners, as every decision and action counts toward saving our Earth.”

Global Recognition of Sustainability Efforts

Acer's endeavors in developing eco-conscious products and environmental-friendly initiatives have been recognized by worldwide media and design experts, a testament to the fact that these efforts are resonating with industry trends.

Multiple Vero products won the 2022 Good Design Awards: namely the Acer Chromebook Vero 514, the Acer Veriton Vero all-in-one, and the Acer Vero CB3 series monitor. The Aspire Vero laptop added to its growing list of accolades with the 2022 iF Design Award and 2022 Red Dot award, and was selected as Sustainability Product of the Year from Business Intelligence Group.

Acer's eco-friendly packaging, film, animation, and Project Humanity campaign designs earned the 2022 Red Dot Brands & Communication Design awards for their creative communication and design excellence.

The award-winning Project Humanity campaign won a Shorty Impact Award in the "Best in Employee Engagement" category. The award celebrates the most impactful and purpose-driven works on digital and social media that make the world a better place.

Smart Cities

Acer also envisions a smart city for a greener and more sustainable future. Its subsidiaries are engaged in various fields of sustainable solutions for everyday living, working on more eco-friendly innovations and application solutions for smarter cities. ([See Chapter 5: Circular Economies and Innovations for more information](#))

Global Efforts for Social and Environmental

Acer and Eduinfo Inaugurate First Lab 2030 Focused on Education Technology in São Paulo, Brazil

Acer, in partnership with Eduinfo, inaugurated the Lab 2030 in November 2022, marking the first laboratory of the Acer Education Experience in Brazil. The pilot project is expected to benefit around 800 students at Colégio Sir Isaac Newton, in São Paulo, where it aims to increase students' interest in their classes by incorporating technological solutions, including those from Google and Microsoft.



Acer and R8G eSports Team Up in "Racing-for-the-Climate" at 2022 Indy eX Prix

Acer teamed up with R8G eSports, one of the top 5 professional sim racing teams in the world, to form the Acer Vero R8G team that completed in the Indy eX Prix at the Indianapolis Motor Speedway on November 2022. Four Acer Vero R8G Ex Zero prototypes, were branded with Aspire Vero and the Earthion mission to raise awareness for the environment and encourage green practices.



Acer Powers the IOI 2022 with Aspire 3 Laptops

Acer was the Official Sponsor of the 34th International Olympiad in Informatics (IOI) held in Indonesia in August 2022. The IOI is a prestigious computer science competition among secondary and high school students. See [Chapter 7: Digital Inclusion and Social Philanthropy for more information](#).





02

ESG GOVERNANCE AND STRATEGY

Acer engages in ongoing review and promotion of important sustainability issues and strives to incorporate sustainable development policies into daily operations. We have established an ESG governance pipeline for the communication of relevant issues, implementing a variety of resolutions and pursuing stronger governance. We review the overall environment and the expectations of our stakeholders to plan Acer ESG policy and more deeply integrate ESG into our overall value chain to boost ESG performance.

- **UN Sustainable Development Goals (SDGs)** 16
- **ESG Governance and 2025 Sustainability Goals** 19
- **Sustainability Value** 22
- **Materiality and Stakeholder Engagement** 23



Participate in the Nature and Biodiversity Initiative



Approval of Climate Change Vision, Strategy and Goals



2022 Sustainability Report with GRI Universal Standards

UN Sustainable Development Goals (SDGs)

The United Nations Sustainable Development Goals (SDGs) cover important sustainability issues and challenges facing mankind. As a corporate citizen, Acer has the power to contribute to the sustainable well-being of mankind. In 2022, we continued to put our products and services to use in the Acer value chain, leveraging our core competencies to continue to address various social and environmental issues and implement the UN Sustainable Development Goals by promoting the universal and innovative application of technology through various programs and solutions.

| Implementing key SDGs in the Acer Value Chain



Ensure healthy lives and promote wellbeing for all at all ages

Ensure people's health and well-being through our products and services.

- Acer and Acerpure collaborate on air quality improvement solutions to understand and improve indoor air quality in real time, helping to reduce human health hazards caused by indoor air pollution
- Acer and Acer Medical develop face recognition system that uses facial emotion to determine possible dementia
- Acer Medical's VeriSee DR assists frontline physicians in caring for diabetic patients by speeding up the time and improving the accuracy of diagnosis and effectively referring high-risk eye disease patients to ophthalmology for follow-up treatment.

Material Topics and Relevant Chapters

- Innovative Products and Services



Ensure inclusive and quality education for all and promote lifelong learning

Acer is committed to shrinking the digital divide and nurturing talent, firm in the belief that technology can inspire people and help tap their potential.

- Acer Brazil's Project Humanity donates "Little Citizens' House" to help vulnerable groups
- Acer Taiwan volunteers help vulnerable students improve their digital skills over time
- Acer donates laptops and tablets to Ukrainian school to enhance educational resources and robotics training programs

Material Topics and Relevant Chapters

- Digital Inclusion and Social Philanthropy



Ensure access to affordable, reliable, sustainable, and modern energy for all

We provide people with more efficient, sustainable, and safe energy usage and encourage our employees to use sustainable energy through our initiatives.

- Acer has been increasing its renewable energy ratio annually and has joined the RE100 initiative, with the Acer Group expecting to use 60% renewable energy by 2025 and RE100 by 2035.
- Acer Spain installs rooftop solar panels to meet RE100 commitment by 2035
- Acer Smart Frequency's energy storage and energy storage extensions provide reliable, clean, green and safe backup power

Material Topics and Relevant Chapters

- Climate Strategy and Transformation
- Digital Inclusion and Social Philanthropy
- Innovative Products and Services



Promote inclusive and sustainable economic growth, employment, and decent work for all

Protect labour rights and promote safe and secure working environments for all workers

- Acer strives to protect the human rights and health of labor and provide a safe workplace, performing on-site audits, which affected some 260,000 employees in 2022.
- Every member of Acer's is treated with dignity in accordance with the principle of fairness. We strive to protect personal privacy, provide channels for the free and safe communication of opinions, and offer a safe, healthy working environment
- We take effective measures to eliminate forced labor, end modern slavery, human trafficking, and ensure the prohibition and eradication of the worst forms of child labor.

Material Topics and Relevant Chapters

- Responsible Supply Chain
- Attracting and Developing Talent



Make cities inclusive, safe, resilient, and sustainable

Through software, hardware, and service products, Acer makes the cities where we live more friendly, inclusive, and accessible.

- Acepure products combine purge and recirculate functions in a 2-in-1 air recirculation cleaner that filters air pollution through intelligent sensing and high-specification HEPA filters to reduce the chance of virus transmission indoors.
- Acer ITS develops smart parking business, integrating diverse payment options, vehicle detection, license plate recognition, and the Parking Lot App to provide smart parking solutions for on-street, parking lot, and other private transportation parking needs.
- Acer Germany has once again launched a bike challenge to encourage employees to ride their bikes to and from work to keep them healthy and reduce CO₂ emissions.

Material Topics and Relevant Chapters

- Innovative Products and Services
- Digital Inclusion and Social Philanthropy



Ensure sustainable consumption and production patterns

Coordinate supply chain stakeholders to implement responsible production/consumption, sustainable management and effective use of natural resources, and reuse/recycling systems.

- Continuously launch eco-friendly computer Vero products made from post-consumer recycled plastic, using non-coated recycled materials, and eco-friendly packaging
- Continuously require supply chain to adhere to list of banned or restricted chemical substances
- Continuously use recycled materials for packaging materials
- Continuously promote global reuse and recycling the program

Material Topics and Relevant Chapters

- Circular Economies and Product Life Cycle
- Innovative Products and Services



Take urgent action to combat climate change and its impacts

Acer is actively implementing climate change response strategies, including drafting low-carbon, sustainable strategies

- 60 % of critical suppliers have completed setting of carbon reduction targets in accordance with Science Based Target (SBT) methodology
- We invite vendors to participate in the Earthion program to help solve climate and environmental challenges with innovative and integrated solutions
- We joined the RE100 initiative and have committed to achieving RE100 by 2035

Material Topics and Relevant Chapters

- Responsible Supply Chain
- Brand Values



Promote peaceful and inclusive societies for sustainable development, provide access to justice for all, and build effective, accountable, and inclusive institutions at all levels

Acer is implementing responsible supervision and management of conflict minerals, working to end all forms of child exploitation, and promoting a peaceful and inclusive society.

- Acer continues to focus on the human rights impacts of our business development, advocate responsible mineral sourcing, and publish responsible minerals reports.

Material Topics and Relevant Chapters

- Responsible Supply Chain



Strengthen the means of implementation and revitalize the global partnership for sustainable development

Acer leverages and implements its core competencies to collaborate and create value with all stakeholders

- Global offices collaborate with various stakeholders on ESG projects
- Launched the Earthion platform, working with our vendor partners toward sustainable environmental and societal development

Material Topics and Relevant Chapters

- Digital Inclusion and Social Philanthropy
- Brand Values



ESG Governance and 2025 Sustainability Goals

| Acer ESG Development Process

- 2008-2010 Foundation period**
 An ESG management mechanism was established
- 2011-2014 Strategy promotion period**
 The concept of sustainability was incorporated into the Company's various business operations while promoting key issues in line with global sustainability trends
- 2015-2024 Value creation period**
 We are reviewing the overall environment and the expectations of our stakeholders to plan the implementation of Acer ESG policy. Through deepening the integration of the organization and value chain, we expect to improve the ESG triple performance and gradually achieve the goals of strengthening governance, developing innovation and building social impact

In addition, as ESG issues evolve and market needs change, Acer continues to pay attention to global ESG trends and actively develops more proactive ESG strategies to meet the world's challenges and opportunities.

| Sustainable Acer

Acer's ESG policies and strategies are aligned with the Company's development direction and the core spirit of the brand:

While pursuing profitability, leading transformation, and providing innovative services, we will continue to create tangible and intangible values, and move toward a future-oriented enterprise by promoting sustainable model transfer and social influence with our three core beliefs of value creation, balance of interests, and sustainable management.

| Acer ESG Policy

We believe that only by enabling companies to be environmentally and socially responsible while making profits will we be able to achieve long-term ESG development and move the world forward in a more sustainable direction. In addition, as ESG issues evolve and market needs change, we actively develop diversified businesses, innovate products and services, and explore new business models for efficient and sustainable operations. Our goal is to enhance group resilience, promote low-carbon and circular strategies, and create greater value for the group and society.

Integrating Sustainability Governance

Deepen ESG governance and stakeholder engagement, and strengthen the overall management and transparent disclosure of both financial and non-financial performances

Pioneering Green Innovations

Incorporate low-carbon, sustainable, and innovative technologies and concepts that advocate for the circular economy into products and services; take lead in smart cities and the development of a new green economy

Comprehensive Sustainability Impact

Create real corporate value and exert our influence on suppliers and partners, and assist the overall industry to move toward a sustainable future

Acer's ESG sustainability strategy focuses on the following three major areas and formulates sustainability goals for 2025:

Circular Economy

As one of the strategies to adapt to climate change, circular economy not only reduces the environmental burden, but also promotes innovation of enterprises.

Climate Change

Net Zero Carbon Emission has become a global consensus, and it is also a mission and challenge that we must take on.

Social Impact

Gathering employees' recognition of and commitment to environmental protection and social participation, cooperating with various stakeholders, and exerting social impact.



2025 Sustainability Goals and 2022 Accomplishments

<div style="background-color: #d9ead3; padding: 10px; border: 1px solid #d9ead3;"> <p style="text-align: center; margin: 0;">CIRCULAR ECONOMY</p> <p style="margin: 5px 0;">Sustainable Design</p> <p style="margin: 5px 0;">Recycled Materials</p> <p style="margin: 5px 0;">Reduce Plastic Packaging</p> <div style="display: flex; justify-content: space-around; margin-top: 10px;"> <div style="text-align: center;"> <p>11 SUSTAINABLE CITIES AND COMMUNITIES</p> </div> <div style="text-align: center;"> <p>12 RESPONSIBLE CONSUMPTION AND PRODUCTION</p> </div> </div> </div>	<div style="background-color: #d9ead3; padding: 10px; border: 1px solid #d9ead3;"> <p style="text-align: center; margin: 0;">CLIMATE CHANGE</p> <p style="margin: 5px 0;">Renewable Energy</p> <p style="margin: 5px 0;">Energy Efficiency</p> <p style="margin: 5px 0;">Carbon Reduction</p> <div style="display: flex; justify-content: space-around; margin-top: 10px;"> <div style="text-align: center;"> <p>7 AFFORDABLE AND CLEAN ENERGY</p> </div> <div style="text-align: center;"> <p>13 CLIMATE ACTION</p> </div> </div> </div>			<div style="background-color: #d9ead3; padding: 10px; border: 1px solid #d9ead3;"> <p style="text-align: center; margin: 0;">SOCIAL IMPACT</p> <p style="margin: 5px 0;">Environmental Friendliness</p> <p style="margin: 5px 0;">IT Education</p> <p style="margin: 5px 0;">Employee Engagement</p> <div style="display: flex; justify-content: space-around; margin-top: 10px;"> <div style="text-align: center;"> <p>4 QUALITY EDUCATION</p> </div> <div style="text-align: center;"> <p>13 CLIMATE ACTION</p> </div> <div style="text-align: center;"> <p>17 PARTNERSHIPS FOR THE GOALS</p> </div> </div> </div>	
2025 Goals	2025 Goals			2025 Goals	
<p>20-30% of PCR plastics content in computers and displays</p>	<p>Acer Group to reach 60% renewable electricity usage * RE100 reached by 2035</p>	<p>45% reduction in average computer energy consumption in 2025, compared to 2016</p>	<p>80% of critical suppliers committed to RE100 or set carbon reduction SBTs</p>	<p>Over 90% of employees engaged in Project Humanity</p>	<p>80% of global employees are actively engaged in their work</p>
2022 Accomplishment	2022 Accomplishment			2022 Accomplishment	
<p style="text-align: center; font-size: 24px; color: #5da5da;">17%</p> <p>17% of PCR plastics content in computers and displays</p>	<p style="text-align: center; font-size: 24px; color: #5da5da;">44%</p> <p>renewable electricity usage</p>	<p style="text-align: center;"> Notebook Computer : 39% Desktop Computer : 35% </p> <p>Rate of reduction in average computer energy consumption</p>	<p style="text-align: center; font-size: 24px; color: #5da5da;">60%</p> <p>Critical suppliers commit to RE100 or set science-based carbon reduction targets (SBT)</p>	<p style="text-align: center; font-size: 24px; color: #5da5da;">71%</p> <p>71% of employees engaged in Project Humanity</p>	<p style="text-align: center; font-size: 24px; color: #5da5da;">78%</p> <p>78% of global employees are actively engaged in their work</p>

| ESG Governance

In accordance with ESG's mission and policies, Acer has established the Corporate Sustainability Committee (CSC), chaired by the Chairman and CEO, with the ESG Office serving as the Executive Secretary. The committee members include: Chief Operating Officer, Chief Legal Officer, Chief Financial Officer, Chief Human Resources Officer, Chief Sustainability Officer and other senior executives, who are responsible for approving sustainability visions, strategies and long-term goals, and reporting regularly to the Board of Directors.

The Corporate Sustainability Committee establishes working groups on corporate governance, risk management, innovation and product lifecycle, environmental management, and supply chain management. These groups address significant sustainability issues across departments, facilitating communication, coordination, and planning for important issues. They also execute and monitor action projects to track progress and effectiveness. The Corporate Sustainability Committee convenes twice a year to oversee and review the sustainability actions and implementation status of each working group, respond to stakeholder requests and expectations, review annual sustainability goals and develop medium- and long-term goals, and discuss and resolve important sustainability issues. Meetings in 2022 were held in June and December with 100% attendance.

The ESG Office is led by the Chief Sustainability Officer, who serves as the Executive Secretary of the Corporate Sustainability Committee. In addition to reporting regularly to the Corporate Sustainability Committee on trends, impacts and performance on sustainability-related issues, the ESG Office also plays a communication and integration role between the working groups and the Corporate Sustainability Committee. In addition, to communicate effectively with our global locations, we have also established ESG Executive Secretary at Regional Headquarters, who is responsible for formulating ESG action plans and programs at regional headquarters to implement various sustainability issues management.

2022 Sustainability Committee Key Resolutions

- Consideration and approval of material ESG topics
- Reviewing the 2022 Sustainability Goals Performance and Action Plan
- Approval of 2023 Sustainability Goals
- Approval of Climate Change Vision, Strategy and Long-Term Goals
- Feedback from Stakeholders



Acer Sustainability Governance Organization

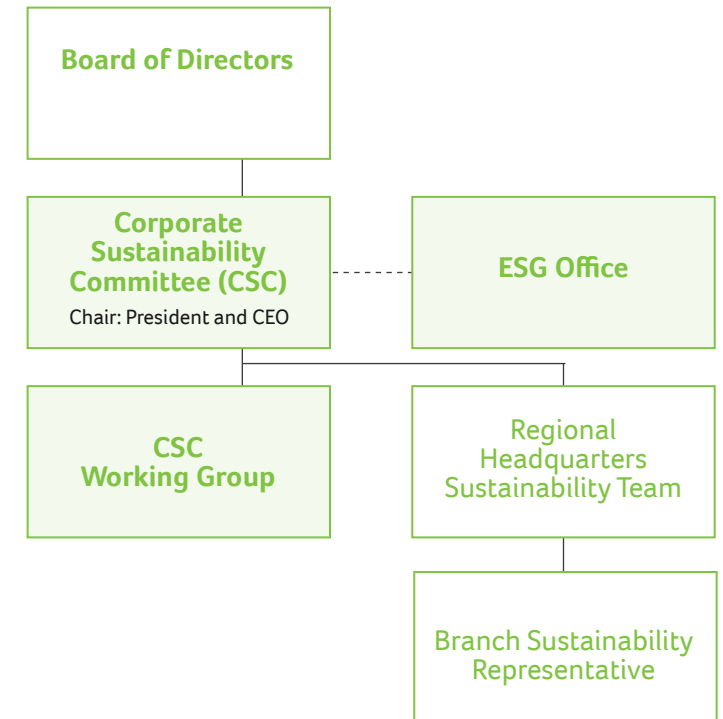

—— Oversight and Management

- - - - Support and Assistance



Sustainability Value

2020 2021 2022

Financial Capital

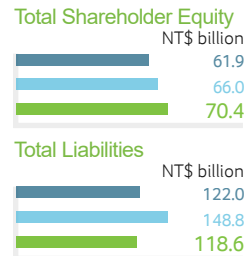

Social and Relational Capital

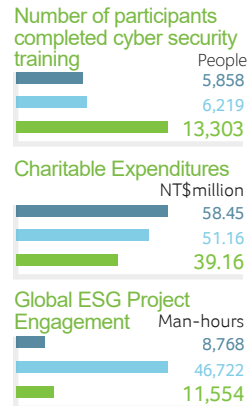

Intellectual Capital

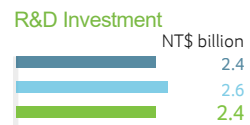

acer Company Mission Breaking down barriers between people and technology

Core Spirit

Acer's mission is breaking down barriers between people and technology. To this end, the Company invests capital in promoting integrated applications and products that bring together hardware, software, and services. Together with employees and stakeholders worldwide, we are committed to R&D, design, marketing, sales, product service, and solutions in the value chain. We measure and monitor the positive and negative social and environmental impacts of our investments, as well as their sustainability value.

Value Chain

Innovative Technologies	Supply Chain Management	Marketing	Service
Co-Creators of Value Staff and Suppliers	Co-Creators of Value Suppliers	Co-Creators of Value Staff	Co-Creators of Value Corporations/Schools/ Customers/Governments/ Communities

Natural Capital

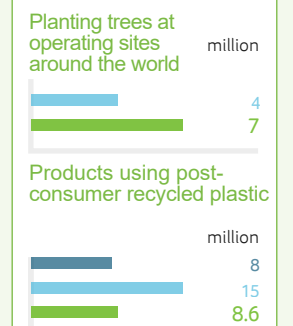

Manpower

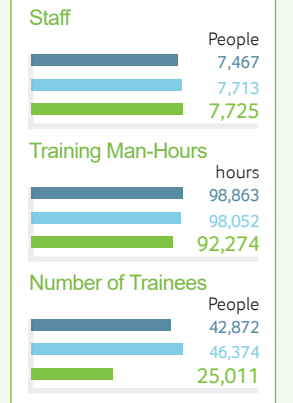

Manufactured Capital

Equipment, Machinery, and Facilities for Global Branches and Retail Channels

Social Value

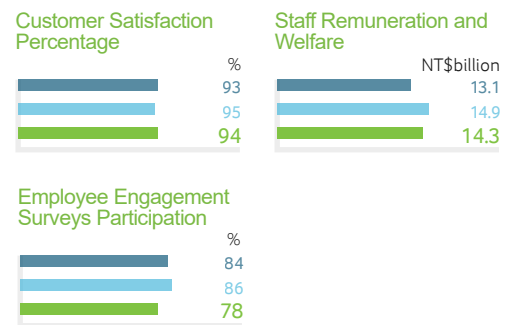

Economic Value

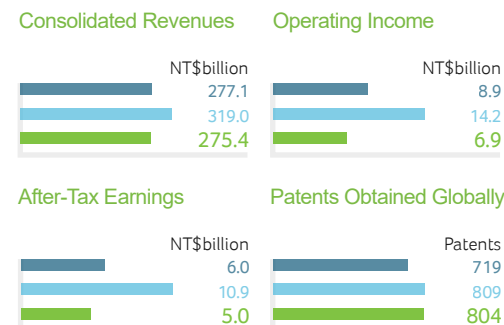

Environmental Value

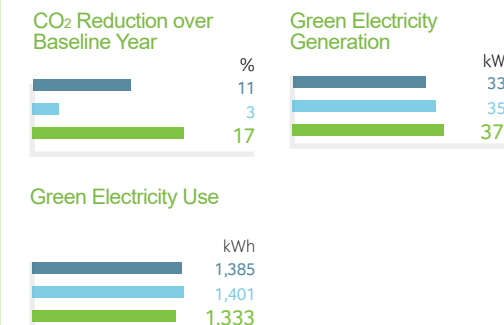

Materiality and Stakeholder Engagement

Materiality Analysis Process

Acer conducts materiality analyses annually by referring to the Universal Standards and the AA 1000 Accountability Principle: 2018 published by the Global Reporting Initiative (GRI). The four principles of Inclusivity, Materiality, Responsiveness and Impact are used to understand stakeholders' concerns about ESG, to strengthen internal and external communication, to respond to stakeholders' expectations for information, and to plan and establish a management structure for ESG information disclosure.



Identifying Stakeholders

In order to achieve sufficient communication and interaction with stakeholders, we refer to the AA1000 SES Stakeholder Engagement Standard's five major aspects, namely responsibility, influence, dependence, tension, and diverse perspectives, to fully identify all stakeholders, including ten types of stakeholders: employees, advocacy organizations, customers, investors, suppliers, public interest groups/ communities, government agencies, industry associations, research institutes, media, to facilitate in-depth communication with them and understand the demands of different stakeholders.



Listing and Compilation of Sustainability Topics

Sustainability topics related to Acer and the information and communications industry are listed. Topics include sustainability standards such as the GRI Universal Standards, the Sustainability Accounting Standards Board (SASB), the Climate Relevant Financial Disclosures (TCFD), and international ESG assessments such as the Dow Jones Sustainability Indices (DJSI) questionnaire, FTSE4Good, MSCI ESG Index; initiatives such as the United Nations Sustainable Development Goals (SDGs), the Responsible Business Alliance Code of Conduct (RBA Code of Conduct), the Renewable Energy Initiative (RE100), the United Nations Global Compact, and the Global e-Sustainability Initiative (GeSI). In addition, taking into account the company's strategic development goals, we have divided the major topics into three categories: governance/economy, society, and environment, and in 2022, we have adjusted the number of topics to 14.



Material Topic Assessment Conducted

We collected extensive stakeholder input. In 2022, an online questionnaire was conducted to collect the opinions of 1,145 internal and external stakeholders. These stakeholders mostly have communication/cooperation with Acer and have a certain level of understanding of Acer's business. In addition, we also sent questionnaires to senior management, including: Chairman and Chief Executive Officer, Co-Chief Operating Officer, Chief Financial Officer, Chief Legal Officer, Chief Human Resources Officer, Chief Sustainability Officer, and Business Group General Managers. From ranking the importance of the topic by the manager and the importance of the issue, identify the senior executive's view of the sustainability topic. The questionnaire was designed to take into account the principle of dual materiality and to collect stakeholders' comments on the following: the degree of impact/impact of material topics on society, the environment, and people, and management's comments on the following: the degree of impact of material topics on Acer's operations.

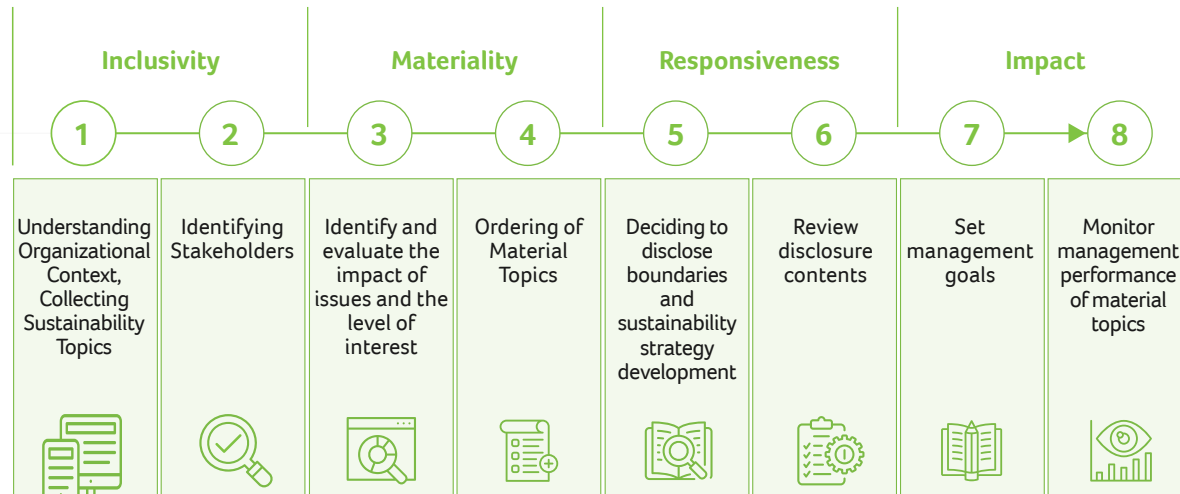



Material Topics Ranking

Based on the results of the questionnaire analysis, a matrix of major topics was compiled, with the X-axis being the impact of material topics on Acer's operations and the Y-axis being the impact of material topics on the environment, society and people. Confirmation in two phases: The results are first reviewed according to the sustainable development, industrial environment, and current situation of the Company, and then examined by the corporate sustainability officer and confirmed by the Corporate Sustainability Committee. The top three most important topics for the Company in 2022 are energy, carbon emissions, climate change ; information security and privacy protection ; and innovative R&D and design. Compared to 2021, there is a significant increase in the ranking of the following topics in 2022: energy, carbon emissions, and climate change; water resources management; and talent attraction, retention, and development. Corporate Governance and Code of Conduct, however, dropped from the top three to sixth place. For the 2022 topic collection, we removed the topics of risk and crisis management, transparency disclosure, large-scale infectious diseases, environmental policy and management, customer management, and conflict minerals, which are already part of Acer's operations and are therefore not listed. In addition, considering the important natural capital of biodiversity and Acer's responsibility and key role in digital inclusion and social good issues, we continue to report and disclose relevant content in this report.



Identification of Material Topics and Boundaries and Review

The Sustainability Committee finalized 11 material topics of medium to high concern and importance, mapped them to the GRI Universal Standards topics, identified the indicators and their boundaries to be disclosed in the Corporate Sustainability Report, and had the content of the disclosure confirmed by an external third party. The result of 2022 Acer materiality assessment is reviewed, approved, and supervised by Acer's Board of Directors.



Set Long-Term Goals for Major Topics

The corporate sustainability committee regularly monitors and reviews the status of goal achievement and discloses the results of ESG engagement in the sustainability report to the public.

Results of Analysis of Material Topics - Matrix



- 1 Energy, Carbon Emissions and Climate Action
- 2 Information Security and Privacy Protection
- 3 Innovative R&D and Design
- 4 Product Responsibility and Customer Safety
- 5 Circular Economies and Product Life Cycle
- 6 Corporate Governance and Code of Ethics/Standards of Conduct
- 7 Talent Attraction, Retention, and Development

- 8 Human Rights, Equality, and Diversity
- 9 Water Resource Management
- 10 Supplier Environmental and Social Management & Performance
- 11 Occupational Health and Safety
- 12 Policy and Public Issues Advocacy
- 13 Biodiversity
- 14 Digital Inclusion and Social Philanthropy



Material Topics Analysis - Impact Assessment

We evaluated the economic, environmental, people, and human rights impact and impact dimensions of the critical topics by referring to the GRI 1 Foundation and GRI 3 Material Topics criteria of the GRI General Guidelines. These impacts can have both positive and negative, actual and potential effects and impacts on the Company, both internally and externally. We understand that these effects or impacts may change over time as the Company's activities, business relationships and environment evolve, and therefore we will continue to evaluate their environmental context and identify their impact.

Material Topics	Topic Description	Positive Impacts	Negative Impacts	Stakeholders affected by the impact/effect	Management Method
1 Energy, Carbon Emissions and Climate Action ▲ 9	Due to the impact of global climate change and extreme climate, more than hundred countries have declared the goal of net zero emissions, and have been implementing policies such as energy saving, carbon reduction, renewable energy, carbon tariffs, and many other climate action programs, affecting business operations and becoming a risk and opportunity for businesses to face in sustainable operation.	Reducing the environmental impact of business operations and promoting Acer's low-carbon transformation to strengthen competitiveness	Regulatory compliance and internalization of carbon costs, affecting operating expenses and product prices	Environmental Industry Associations Government Agencies	Chapter VI Climate Strategy and Transformation
2 Information Security and Privacy Protection ■ 2	We improve our information security management system, including the establishment of policies, notification, management, and prevention mechanisms, and incorporate information security into our corporate governance objectives; protect customer data in product design and services; and implement personal data protection policies and measures, as well as related complaint handling mechanisms.	Information Security: Ensure the confidentiality, integrity, availability and legality of information, and maintain customer trust Protecting Privacy: To prevent improper disclosure of information and to protect information, property and personal rights in the private domain from infringement.	Information Security: Geopolitical influence and surge in cyber attacks affect good business reputation Protecting Privacy: Leads to the leakage of personal information, which in turn violates the rights and dignity of individuals in the private territory.	Employees Customers	Chapter III Operations and Governance - Information Security and Privacy Protection
3 Innovative R&D and Design ■ 3	Invest in innovative R&D capabilities, promote the acquisition and maintenance of intellectual property and patents, and develop solutions that respond to the development and sustainability needs of society, focusing on machine learning, data analytics, artificial intelligence-assisted medical solutions, and smart cities, in addition to computer and display technologies.	Strengthen the competitiveness of our products by considering R&D and design from the perspective of consumer needs	Expertise, skills or resource input may increase labor, cost requirements or generate waste	Customers Suppliers	Chapter V Circular Economy and Innovation - Innovative Products and Services
4 Product Responsibility and Customer Safety ▼ 3	Ensure the quality and safety of products and services, and the impact of raw material use on the environment and users	Improve product safety and quality of service and reduce the impact of raw materials on users and the environment	Possible additional management, testing, inspection and other items, resulting in higher costs in production, manpower, time, etc.	Customers	Chapter V Circular Economies and Innovation

▲ The importance ranking of the topics has increased compared to 2021 ▼ The importance ranking of the issues has decreased compared to 2021 ■ The importance ranking of the topics is the same as in 2021 (The number following the symbol represents the ranking in 2021.)



Material Topics	Topic Description	Positive Impacts	Negative Impacts	Stakeholders affected by the impact/effect	Management Method
5 Circular Economies and Product Life Cycle ■ 5	Through product lifecycle management, Acer reduces their potential impact on the environment. We actively strive to find a balance between product management and environmental performance in order to provide more environmentally and commercially competitive products.	Create new business models, recycle materials and reduce resource consumption	When recycling substances or materials, additional costs, manpower and resources may be incurred during the recycling, manufacturing and transportation processes, and the carbon footprint may increase during the corresponding stages.	Customers Suppliers Environmental	Chapter V Circular Economies and Innovation
6 Corporate Governance and Code of Ethics/Standards of Conduct ▼ 1	Corporate governance and the Code of Conduct serve as Acer's guidance and management mechanisms, including the setting of company operating targets, monitoring implementation of targets and operational performance, and protecting the legal rights of shareholders and the interests of other stakeholders.	To strengthen the reputation of trust, integrity and honesty by laying the foundation of corporate management and operation, i.e., the code of honest management and business conduct, through concrete implementation	Neglecting long-term sustainability in the operation process and pursuing short-term profits may harm the interests of the Company's shareholders and stakeholders, and put the Company at legal risk	Employees Investors	Chapter III Operations and Governance - Corporate Governance
7 Talent Attraction, Retention, and Development ▲10	Composition of employees, hiring and termination, competitive compensation and benefits, investment in talent development and nurturing (e.g., industry-academia partnerships, internship programs)	Facilitate the expansion of the Company's diversified business to enhance employee strength and employer brand value; build human capital and ensure the organization's competitive advantage	Reduce employee recognition, increase personnel costs, and affect business operations; the rapid evolution of lifestyle brand-related technologies and diversified product end-customer needs pose challenges to organizational talent cultivation	Employee	Chapter VII Inclusive Workplace and Society - Attracting and Developing Talent
8 Human Rights, Equality, and Diversity ▼ 7	Gender equality, equal pay for equal work, employee diversity and equal opportunities, non-discrimination, freedom of association and collective bargaining, and the provision of diverse channels and frequency of communication to promote harmonious labor relations	Improve employee satisfaction, attract and retain talent, increase productivity, and drive the supply chain for social justice	Talent loss, innovation slowdown, brand image damage, legal risk	Acer Employees Suppliers and their Employees	Chapter VII Inclusive Workplace and Society - Human Rights Protection
9 Water Resource Management ▲16	Water management planning, strategy, effectiveness and wastewater treatment, water reduction results and goals	Reduce the impact of business operations on the environment and promote the recycling of water resources	Operation model has no production process, the reduction effect is limited.	Environmental	Chapter III Operations and Governance - Operations and Environment

▲ The importance ranking of the topics has increased compared to 2021 ▼ The importance ranking of the issues has decreased compared to 2021 ■ The importance ranking of the topics is the same as in 2021 (The number following the symbol represents the ranking in 2021.)



Material Topics	Topic Description	Positive Impacts	Negative Impacts	Stakeholders affected by the impact/effect	Management Method
10 Supplier Environmental and Social Management & Performance ▲ 4	Through the management mechanism of the supply chain, the environmental risks are reduced and the environmental performance of the whole supply chain is actively sought; the social and environmental responsibilities are shared with the supply chain based on respect for human rights.	Ensure that the work environment, safety and health, and personnel are treated with respect and dignity	Risk of Environmental Impact and Human Rights Violations	Suppliers and their Employees Environmental	Chapter IV Responsible Supply Chain
11 Occupational Health and Safety ■ 11	Provide a safe and healthy working environment for employees, strengthen the health management of employees, and maintain competitiveness for the Company.	Attract talents to enhance the competitiveness of the corporation	Meet stakeholder needs and expectations may increase manpower and material investment costs	Employees	Chapter VII Inclusive Workplace and Society - Health and Safety in the Workplace
12 Policy and Public Issues Advocacy ▲ 18	Contribute to the development of public policy through participation in industry associations and societies by providing advice on public policy development	Stay informed about the latest developments in public policies related to the economy, environment, and human rights. By doing so, we strive to be well-versed in these areas and utilize Acer's experience and influence to make a positive impact.	Participating in various issue-related NGOs and initiatives may increase operating expenses and manpower costs	Government Agencies Advocacy Organizations	Chapter II ESG Governance and Strategy - Materiality and Stakeholder Engagement
13 Biodiversity NA	Biodiversity is an important natural capital and companies need to understand the risks associated with their operations' impacts on biodiversity and should take mitigating actions.	Through the Acer brand and influence on the supply chain, we ensure that our operations do not affect the environment and that the issue of biodiversity is given more importance	If people do not pay attention to biodiversity issues, they may not realize the importance of biodiversity and inadvertently cause impacts to it.	Environmental	Chapter III Operations and Governance - Operations and Environment
14 Digital Inclusion and Social Philanthropy ▲ 13	Companies use their core competencies to take action to address the social and environmental issues facing humanity to reduce social costs and indirectly reduce the company's business risks. Help everyone enjoy the convenience and opportunities technology brings, and promote Digital Inclusion	By utilizing core capabilities, employing technology, and taking concrete actions, we can respond to and address the social and environmental issues faced by humanity. It not only reduces costs to society, but also indirectly reduce the business risks faced by the company. At the same time, such actions help promote the coexistence business, society, and the environment	It may increase the company's operation expenses to organize various events.	Advocacy Organizations Charity Groups	Chapter VII Inclusive Workplace and Society - Digital Inclusion and Social Philanthropy

▲ The importance ranking of the topics has increased compared to 2021 ▼ The importance ranking of the issues has decreased compared to 2021 ■ The importance ranking of the topics is the same as in 2021 (The number following the symbol represents the ranking in 2021.)



Material Topics Boundary Definition and Relevant Indicators

Material Topics	Responding to SDGs	Topic Category	Response to GRI Standards/SASB Indicators/Acer Indicators	Company-Internal Boundary		Company-External Boundary		
				Headquarters	Regional Headquarters/Subsidiary	Customers	Suppliers	Community
Primary Material Topics								
Energy, Carbon Emissions and Climate Action		Environmental	GRI 302-1~302-5, GRI 305-1~305-5	○	○	○	○	
Information Security and Privacy Protection		Social	GRI 418-1, SASB TC-HW-230a.1, Acer EC1	○	○	○	○	
Innovative R&D and Design		Governance/Economic	Acer EC4~6	○	○		○	
Product Responsibility and Customer Safety		Environmental	GRI 416-1, Acer EN1	○	○	○		
Circular Economies and Product Life Cycle		Environmental	GRI 301-3, SASB TC-HW-410a.1	○	○	○	○	
Corporate Governance and Code of Ethics/Standards of Conduct		Governance/Economic	GRI 2-9~2-12, 2-15~2-18, 2-23, 2-26, 2-27, 405-1, 416-2, 417-2, 417-3	○	○	○	○	○
Talent Attraction, Retention, and Development		Social	GRI 404-1~404-3, GRI 405-2, Acer SO4	○	○			
Human Rights, Equality, and Diversity		Social	GRI 402-1, 405-1~2, 406-1, 407-1~3, SASB TC-HW-330a.1	○	○			
Water Resource Management		Environmental	GRI 303	○	○		○	○
Supplier Environmental and Social Management & Performance		Governance/Economic	GRI 2-6, 308, 408, 409, 414, 308-1, 308-2, SASB: TC-HW-430a.1~2	○			○	
Occupational Health and Safety		Social	GRI 403	○	○		○	
Secondary Material Topics								
Public Policy and Initiatives		Governance/Economic	GRI 2-28	○	○			
Biodiversity		Environmental	GRI 402-1	○	○	○	○	○
Digital Inclusion and Social Philanthropy		Social	GRI 405-1~2	○	○			○

Note: We have made a complete disclosure of management methods for material topics and a partial disclosure of GRI indicators for secondary material topics.



Stakeholder Engagement

Deepening corporate responsibility governance and stakeholder engagement is one of the ESG-oriented aspects of Acer's policy; In addition, balancing interests, overcoming difficulties, working with stakeholders to create shared value, and creating win-win industrial ecologies are parts of the core spirit of Acer's brand. Through communication, consultation, dialog, and cooperation, we create mutual exchange with stakeholders. In order to use the results of this communication to promote ongoing progress, we have also established a communications evaluation mechanism and procedure for managing issues of concern. These are aimed at properly managing the opinions of different stakeholders as collected and assessed through communication channels, and at helping us achieve the expected level of communicative performance.

<p>Employees</p>  <p>As the company has undergone its transformation, Acer's internal employee communication channels have helped build consensus and commitment among staff and get everyone on the same page regarding our transformational efforts.</p>	<p>Main Communication Channels and Frequency</p> <ul style="list-style-type: none"> • Acer Good News /occasional • Acer Daily News /daily • Chairman & CEO's message /occasional • Internal Website (My Acer/company intranet) /occasional • External Website (Acer Group) /as needed • Labor-Management Meetings/Employee Representatives Organization /quarterly • Employee Benefits Committee /as needed • Email Bulletins /as needed • Internal Investigations /occasional • Education and Training /annual • Pandemic Prevention Team Mailbox /as needed 	<p>Report Section</p> <ul style="list-style-type: none"> • Inclusive Workplace and Society • Circular Economies and Innovation • Climate Strategy and Transformation
<p>Topics of Concern and Our Responses</p>		
<p>Occupational Health and Safety</p> <ul style="list-style-type: none"> • We maintain occupational health and safety management performance. Acer Taiwan continues to pass ISO 45001 certification and build a safe and healthy working environment. • We continue to build a positive and healthy workplace atmosphere and enrich Acer's life by providing a comprehensive welfare plan to enable employees to take care of both physical and mental health. 	<p>Product Responsibility and Customer Safety</p> <ul style="list-style-type: none"> • We follow safety-related regulations and hazardous substance control during the product development and manufacturing stages to provide safe and environmentally friendly products to users. 	<p>Energy, Carbon Emission and Climate Change</p> <ul style="list-style-type: none"> • The "21 Days of Green" environmental campaign was launched to inspire employees, corporate partners and suppliers to reduce their carbon footprint together. • We continue to work with non-profit organizations to raise environmental awareness in the community and among Acer employees to initiate action. • We continue to promote our global ESG program and encourage our employees to focus on "environmental" issues.
<p>Charity Groups/Communities</p>  <p>The true value of business lies in how it can create value for society. As such, we apply our core competencies to social participation, working together to create more opportunities.</p>	<p>Main Communication Channels and Frequency</p> <ul style="list-style-type: none"> • Acer Sustainability Website /as needed • Sustainable Report /annual • Acer Official Website /as needed • Acer Foundation Website /as needed • Volunteer Activities /regular times each year • Complaints Mailbox /as needed 	<p>Report Section</p> <ul style="list-style-type: none"> • Climate Strategy and Transformation • Attracting and Developing Talent • Digital Inclusion and Social Philanthropy
<p>Topics of Concern and Our Responses</p>		
<p>Energy, Carbon Emission and Climate Change</p> <ul style="list-style-type: none"> • We encourage our employees to take action to protect the environment and organize environmental related activities and invite the community to participate. 	<p>Talent Attraction Retention, and Development</p> <ul style="list-style-type: none"> • We continue to strengthen our best employer brand image and offer competitive compensation/benefits to attract and retain talent 	<p>Digital Inclusion and Social Philanthropy</p> <ul style="list-style-type: none"> • We continue to host the Global ESG Project Awards, with two main themes: education and environment, where Acer employees make a social impact and respond to and assist the needs of local communities and stakeholders.

Customers



Creating value for customers is one of Acer's core values. We start from a user-centric perspective and provide solutions and services that meet their needs perfectly.

Main Communication Channels and Frequency

- Email and Telephone Contacts /as needed
- Questionnaires and Surveys /quarterly
- Acer Sustainability Website /as needed
- Corporate Sustainable Report /annual
- Corporate Responsibility Mailbox (cr@acer.com) /as needed
- Acer Official Website /Support page
- Customer Service Line /as needed
- Online Chat /as needed
- Social Networking Software /as needed

Report Section

- Operations and Governance
- Responsible Supply Chain

Topics of Concern and Our Responses

Corporate Governance and Code of Ethics/Standards of Conduct

- We continue to streamline the internal and external personnel reporting pipelines and implement a whistleblower protection system
- Acer promotes the establishment of mutual integrity pledges for contracts with customers or suppliers.

Supplier Environmental and Social Management & Performance

- We continue to require critical suppliers to commit to RE100 or to set aggressive carbon reduction targets based on the Science Based Targets (SBT) methodology
- We continuously improve our manpower and operating environment.
- We continue to move towards the goal of 100% smelter conformance to an OECD due diligence third party mechanism

Information Security and Privacy Protection

- We continue to strengthen employees' awareness of personal data and privacy through various kinds of publicity from time to time, and further enhance the depth and breadth of education and training on related issues.
- We have implemented a personal information management system to enhance the functions and orientation of personal information management, record keeping and inquiry.

Suppliers



Acer considers our relationship with our suppliers a symbiotic one, and as such we will continue to work closely with them to establish a responsible supply chain.

Main Communication Channels and Frequency

- Annual Supplier ESG Communication Meetings /annual
- ESG Scorecard /annual
- RBA On-site Examination /annual
- Launch Second-tier Supply Chain RBA Management (document review, on-site spot-checks) /annual
- On-site Education and Training /occasional
- Business Review Meetings /quarterly
- Supplier Surveys /occasional
- Whistleblower Complaint Mailbox /occasional

Report Section

- Circular Economies and Innovation
- Inclusive Workplace and Society
- Operations and Governance

Topics of Concern and Our Responses

Product Responsibility and Customer Safety

- We follow safety-related regulations and hazardous substance control during the product development and manufacturing stages to provide safe and environmentally friendly products to users.

Occupational Health and Safety

- Acer requires suppliers to adopt environmentally responsible manufacturing procedures and provide healthy and safe working conditions. For 2022 supplier's RBA Code of Conduct audit, the compliance in health and safety was 94%.

Corporate Governance and Code of Ethics/Standards of Conduct

- Suppliers are required to sign an integrity pledge.
- We continuously and regularly disseminate policies related to the Standards of Conduct and conduct online training courses for our global employees to promote compliance awareness.



Investors



Investors are among Acer’s most important stakeholders, and as such we should be responsible to our shareholders and protect their rights and interests.

Main Communication Channels and Frequency

- Regular Shareholders’ Meeting/Institutional Investors’ Conference Call /annual
- Issue Annual Reports, Quarterly Reports and Sustainability Reports on a regular basis
- Investor Mailbox /occasional
- Investor Relations Webpage /monthly
- Analyst Report /YouTube video link
- Investors Summits /annual
- Investor Questionnaires /annual

Report Section

- Circular Economies and Innovation
- Inclusive Workplace and Society

Topics of Concern and Our Responses

Circular Economies and Product Life Cycle

- We responded to material topics of concern to investors, including corporate governance, environmental and social aspects, and the results were presented in various ESG ratings for 2022.

Product Responsibility and Customer Safety

- We follow safety-related regulations and hazardous substance control during the product development and manufacturing stages to provide safe and environmentally friendly products to users.
- In line with Vero's product line, we use uncoated recycled materials for notebooks, desktops, monitors, projectors, and peripheral products.
- Through our design, actively using post-consumer recycled plastics and ocean bound plastics to reduce the waste of electronic products into plastic trash or possible environmental pollution.

Occupational Health and Safety

- Acer Taiwan continues to achieve ISO 45001 certification to maintain health and safety management performance.
- We build a safe and healthy working environment, with no major occupational disasters by 2022.

Industry Associations



Industry associations play an important role in industry consolidation, and can spur the development of Acer and the industry more broadly.

Main Communication Channels and Frequency

- Participating in organizational conferences and fulfilling membership obligations /occasional
- Participating in cooperative events and meetings /occasional
- Email and telephone /as needed

Report Section

- Circular Economies and Innovation
- Responsible Supply Chain
- ESG Governance and Strategy

Topics of Concern and Our Responses

Circular Economies and Product Life Cycle

- Participating continuously in the U.S. IT Industry Environmental Leadership Council, working groups on green purchasing, product stewardship and energy efficiency issues

Supply Chain Environment and Social Performance

- Continually observe or participate in RBA's various initiatives and working groups, such as the Responsible Minerals Initiative (RMI), the Responsible Labor Initiative (RLI), the Environmental Sustainability Working Group and its various subgroups, including the RMI Smelter Engagement Team (SET), the Chemical Stewardship Group and the Due Diligence Practices Group.

Energy, Carbon Emission and Climate Change

- Acer, together with other technology companies, participated in the inaugural meeting and the first board of directors and supervisors of the Taiwan Climate Partnership to help Taiwan's supply chain connect with the international community in terms of green energy and carbon reduction, and to unite the strength of our partners to communicate extensively with international organizations in response to global climate trends.



Educational and Research Institutions

Educational and research institutions provide companies with new ideas and perspectives, and industry-academia cooperation can help both stay on the pulse of industrial development, creating a win-win situation.



Main Communication Channels and Frequency

- Industry-Academia Exchanges /occasional
- Surveys and Interviews /annual
- Conference Activities /occasional
- Acer Sustainability Website /occasional
- Sustainable Report /annual

Report Section

- Circular Economies and Innovation
- Inclusive Workplace and Society

Topics of Concern and Our Responses

Product Responsibility and Customer Safety

- We follow safety-related regulations and hazardous substance control during the product development and manufacturing stages to provide safe and environmentally friendly products to users.
- In line with Vero's product line, we use non-coated recycled materials for notebooks, desktops, monitors, projectors and peripheral products.

Talent Attraction, Retention, and Development; Circular Economies and Product Life Cycle

- On behalf of Acer, Chief Sustainability Officer Ms. Grace Liu participated in the "Female STEM Workshop" held by Chung Yuan Christian University, sharing her experience of Acer's corporate sustainability and the diversity of the Company's culture and employee composition.
- We proactively collaborate with schools to organize corporate visits or through other channels to enhance employer brand image, company ESG practices, and provide participating students with a better understanding of industry trends and future directions

Government Agencies

Gaining the trust, support, and cooperation of the government to help the company create a positive external environmental and a foundation for further growth for Acer.



Main Communication Channels and Frequency

- Responding to Legal Advice /occasional
- Policy Advice Meetings /occasional
- Topic Meetings /occasional

Report Section

- Circular Economies and Innovation
- Digital Inclusion and Social Philanthropy

Topics of Concern and Our Responses

Circular Economies and Product Life Cycle

- Around the world, Acer follows local government standards for various electronic product recycling programs and provides convenient recycling methods for consumers to improve the efficiency of waste recycling
- Acer's products are designed to meet the legal and regulatory requirements of the regions where they are sold

Digital Inclusion and Social Philanthropy

- Acer and Taiwan's Ministry of Digital Development collaborate to donate laptops and tablets to Ukraine for replacing obsolete equipment in school computer labs

Public Policy and Initiatives

- We work with global NGOs and companies to improve the sustainability of the ICT industry, and we have long been involved in sustainability-related organizations as a member to discuss ESG-related issues in depth. In 2022, Acer joined the Taiwan Nature Positive Initiative launched by the Business Council for Sustainable Development.



Advocacy Organizations



Advocacy organizations serve to motivate companies to implement social responsibility, and can help Acer strengthen its own ESG practices.

Main Communication Channels and Frequency

- Acer Sustainability Website /occasional
- Sustainable Report /annual
- Questionnaires and Surveys /quarterly
- Corporate Responsibility Mailbox /as needed
- Complaints Mailbox /as needed

Report Section

- Inclusive Workplace and Society
- Operations and Governance
- Climate Strategy and Transformation

Topics of Concern and Our Responses

Occupational Health and Safety ; Talent Attraction Retention, and Development

- We joined "TALENT, in Taiwan, the Taiwan Alliance for Talent Sustainability" to implement the "Organizational Communication" and "Physical and Mental Health" indicators.

Energy and Climate Change

- The "Green Deals" initiative was launched in 14 European countries to plant trees for orders of Green Deals laptops purchased through Acer's official online store.
- We participated in the inaugural meeting of the Taiwan Climate Alliance, joining hands with the international supply chain to move towards net zero, and to join forces with partners to work more extensively with international climate advocacy organizations.

Biodiversity

- We joined the Nature and Biodiversity Initiative launched by the Business Council for Sustainable Development

Media



The media plays an important role in information transfer and monitoring, shaping the public's understanding and awareness of Acer. Acer insists on communicating with the media with accuracy and in a timely manner.

Main Communication Channels and Frequency

- Press Conferences /occasional
- Press Releases and Promotional Articles /as needed
- Social and Digital Media /as needed
- Corporate Websites /as needed
- Marketing and Media Communication Events /regular

Report Section

- About Acer
- Circular Economies and Innovation
- Climate Strategy and Transformation

Topics of Concern and Our Responses

Energy, Carbon Emission and Climate Change

- Acer and the R8G e-sports team are "fighting for climate" in the 2022 Indy eX Prix competition. Four Acer Vero R8G Ex Zero models, all with the Aspire Vero and Earthion logos, are designed to raise public awareness of environmental sustainability.

Innovative Product and Design

- At the 2022 next@acer Global Launch, Acer unveiled the new Vero series of environmentally sustainable design products, fulfilling Acer's commitment to a sustainable future and providing consumers, businesses and organizations with more choices to reduce their environmental footprint.

| Major Advocacy Initiatives and Participation

To facilitate more in-depth discussion of ESG-related issues and work with NGOs around the world on improving ICT industry sustainability. We have been a long-time member of organizations interested in issues of sustainability, striving to make use of Acer's influence to inspire other businesses to take more proactive measures in this regard. In 2022, Acer joined Taiwan Nature Positive Initiative launched by the Business Council for Sustainable Development to further understand relevant international trends and to respond to stakeholder expectations in advance.

· Comprehensive Sustainable Development Issues

Information Technology Industry Council, Environment and Sustainability Affiliate Group
 Business Council for Sustainable Development of Taiwan
 Center for Corporate Sustainability
 Common Wealth Sustainability Conference

· Human Rights

Responsible Business Alliance (RBA)
 Public-Private Alliance for Responsible Minerals Trade (PPA)
 Responsible Minerals Initiative (RMI)

· Climate Management

CDP supply chain
 Corporate Green Competitiveness Alliance
 RE100
 Taiwan Climate Partnership
 Taiwan Nature Positive Initiative (TNPI)

| Stakeholders Communication

Material Topics

Talent Attraction, Retention, and Development

Stakeholders in Communication

Educational and Research Institutions



"Female STEM Workshop" to Share Corporate Sustainability Experiences

In November, 2022, Acer's Chief Sustainability Officer, Grace Liu, represented Acer to participate in the "Female STEM Workshop" held by Chung Yuan Christian University. In addition to sharing Acer's commitment to corporate sustainability, she also shared Acer's culture and its employee composition. Acer has a high percentage of female employees at both the entry level and management level, as well as in positions related to STEM fields. 37% of the total number of female Acer employees and 37% of female executives were employed in 2021. In addition, Chief Sustainability Officer also shared the [Acer STEM award program](#) launched by Acer UK in partnership with the Tablet Academy. This program is designed to respond to today's educational needs by providing the tools necessary to provide students with more engaging ways to learn and to enable them to acquire the skills to succeed in the future. Additional rewards will be given for recycling old computer equipment on campus. Finally, the Chief Sustainability Officer encouraged the young female workers and students to develop their potential and contribute through the lens of technology and diverse creativity.



Material Topics
Energy, Carbon Emissions and Climate Action

Stakeholders in Communication
Industry Associations



Taiwan Climate Partnership Inauguration

As one of the founding members of the Taiwan Climate Partnership, Acer participated in the inauguration and the first board meeting in August 2022, along with other technology companies including AUO, Delta Electronics, TSMC, Microsoft Taiwan, Lite-On Technology, Pegatron and ASUSTeK Computer.

The mission of the Taiwan Climate Partnership is to assist Taiwan's supply chain in green energy and carbon reduction to connect with the international community, and to combine the strengths of its partners to communicate extensively with international organizations to connect with the global climate trends. It also systematizes the low-carbon transformation and solve the problems through the interconnection of partnership members. The Partnership has organized dozens of climate roundtables to bring together industry, government, academia and other stakeholders to keep abreast of the latest trends in net zero issues at both domestic and international levels.

By participating in professional conferences, it has discussed with government departments on strategies and proposals for Taiwan's 2050 net zero emissions from industry, technology, and policy perspectives. In the future, the Partnership will focus on four core tasks, including the layout of emerging climate technologies, green power and energy technologies, carbon market mechanism, and public participation.



Members of the first board of directors and supervisors of the Taiwan Climate Partnership Source of photo: Taiwan Climate Partnership

[Learn more](#)

Material Topics
Circular Economies and Product Life Cycle

Stakeholders in Communication
Industry Associations



Information Technology Industry Council Environment & Sustainability Affiliate Group

In 2022, Acer continued its membership with the Information Technology Industry Council, Environment and Sustainability affiliate group. As a member, Acer has access to industry-leading staff expertise on regulatory compliance and product and corporate standards development and implementation. The organization's influence enables connections to key government officials, industry experts, intelligence, and industry benchmarking through involvement in working groups and face-to-face meetings. ITI Environment and Sustainability also provides access to compliance calendars, tools, and collective reporting services to improve compliance efficiency for members.

Acer continued to participate in three main working groups within the ITI Environment and Sustainability group that address green procurement, product stewardship, and energy efficiency, where members discuss emerging and existing tech policies and standards and provide industry expertise to guide the development and maintenance of these policies and standards.

Acer also continued its participation in the Right-to-Repair task group, which was convened to get feedback from membership and to develop a strategic approach to the many proposed laws and stakeholder pressures to address product lifecycle, spare parts availability, independent repair, etc. of electronic products in the United States and the European Union. The group developed an industry consensus on a pathway to enable legislators and industry to develop fair, safe, & sustainable repair program legislation and saw the first of its kind passing of the New York Digital Fair Repair Act, which requires original equipment manufacturers to provide spare parts, diagnostic and repair information to independent repair providers and consumers.

[Learn more](#)



Material Topics
Supplier Environment and Social Management

Stakeholders in Communication
Industry Associations



Responsible Business Alliance (RBA)

Acer continued its involvement in the Responsible Business Alliance (RBA), the largest multi-sector industry coalition dedicated to corporate social responsibility in global supply chains. Acer observes or participates in RBA's various initiatives and working groups, such as the Responsible Minerals Initiative (RMI), Responsible Labor Initiative (RLI), Environmental Sustainability Working Group, and its various subgroups, including the RMI Smelter Engagement Team (SET), Chemical Management Working Group, and Due Diligence Practices Team.

In 2022, Acer continued its involvement in the RMI Smelter Engagement Team, on the Global Level 1 Research team. The primary responsibilities of the group are to reach out to alleged smelters to determine if they are true smelters and to provide details for inclusion the RMI's smelter database. This provided the necessary information to prepare the next SET team level for initial smelter outreach with the goal of gaining the smelter's participation in the Responsible Minerals Assurance Process (RMAP). In 2022, the SET team expanded into emerging minerals, such as lithium, and held an education session with a representative from the Lithium Association to inform SET team participants about lithium processing methods and stages, as well as the uses and markets for lithium. This knowledge enabled the team to better identify true processors of lithium and provide a basis of knowledge during discussions with processors.

[Learn more](#)

Material Topics
Supplier Environment and Social Management

Stakeholders in Communication
Advocacy Organization



Private Public-Private Alliance for Responsible Minerals Trade (PPA)

Acer continued its involvement in the PPA, a multi-sector and multi-stakeholder advocacy group that aims to publicize the issue of conflict minerals in the Democratic Republic of the Congo and the African Great Lakes Region and propose supply chain solutions. In October of 2022, Acer attended the annual multi-stakeholder membership meeting, which was held in a hybrid model due to the easing impacts of Covid-19. A total of 45 members met in-person and virtually to learn about and discuss the outcomes of the PPA's work in 2022, celebrated the soft launch of the next phase of the PPA, heard findings and takeaways from recent PPA grantee activities, learned of opportunities to work in tandem with the U.S. Government initiatives around a just energy transition, and engaged in horizon-scanning to inform 2023 work planning. The Secretariat shared a proposed PPA Next Generation MOU with organizations seeking re-enrollment to support early coordination with legal teams and other relevant personnel. Acer has expressed its interest in joining the next phase MOU for 2022-2027. Acer continues to believe that working together as an industry and in partnership with all stakeholders is the most efficient way to enable success at driving meaningful improvement in the social and environmental conditions associated with raw materials extraction.

[Learn more](#)



03

OPERATIONS AND GOVERNANCE

Acer is committed to cooperating with all relevant stakeholders to create a sustainable future together. We have a comprehensive system to strengthen our corporate governance. We set operational goals, review the achievement of those goals and the performance of our operations, protect the legitimate interests of our shareholders and take into account the interests of relevant parties. Meanwhile, we analyze risk trends and implement relevant risk management strategies to build a risk-aware corporate culture through communication and training. We promote company-wide information security management systems to reduce the threat and impact of information security incidents. We also actively understand and respond to the needs of our customers, value the protection of customer data and privacy, and continue to introduce products and services that satisfy our customers. In addition, we take the environmental impact of our operations seriously and work with our staff and relevant stakeholders to implement relevant environmental protection actions.

• Corporate Governance	38
• Risk Management	46
• Information Security and Privacy Protection	51
• Customer Service	58
• Operations and Environment	63

25,011

Global completion of education and training on Standards of Integrity Management & Business Conduct

94%

Percentage of positive customer evaluations

14,334

Global completion of personal privacy education and training

Corporate Governance

Corporate Governance and Code of Ethics/ Standards of Conduct

Indicators related to GRI/SASB

GRI 2-9~12, 2-15~18, 2-19~21, 2-23, 2-26~27, 205-1~3, 405-1, 406-1, 416-2, 417-2~3

Policies/ Commitments

The Company has established the corporate governance system based on an effective governance structure and the three core principles, namely, sustainable management, value creation and balance of interests. In addition to complying with laws and regulations, the Company's Articles of Incorporation, and relevant regulatory matters, the Company has set the following principles as the goal of strengthening corporate governance:

- Protecting shareholders' rights.
- Strengthening the functions of the Board of Directors (including performing the supervisory function of the Audit Committee)
- Respecting the rights of stakeholders.
- Enhancing information transparency and privacy protection.

Acer Group subsidiaries are encouraged to establish a Standards of Integrity Management & Business Conduct (SBC), and to set up a monitoring mechanism to implement ethical operations; and to urge investment companies over which Acer has no direct control to adhere to the highest standards of business ethics and compliance.

[Corporate Governance Code of Practice of Acer Inc.](#)

Action Plan

- Standards of Integrity Management & Business Conduct are linked to performance evaluation to implement integrity management.
- Continuously promote and regularly conduct education and training on Standards of Integrity Management & Business Conduct.
- Require all vendors to meet the Responsible Business Alliance (RBA) Code of Conduct.
- Continue to streamline internal and external personnel reporting pipelines, and implement a whistleblower protection system.

Tracking Mechanism

- Set out Measures for Performance Evaluation of the Board of Directors and announce results of annual director performance evaluations on company website.
- Acer has an internal audit office, which is an independent unit under the Board of Directors. It prepares annual audit plans and reports regularly to the Audit Committee and the Board of Directors to ensure that the company and its employees operate with integrity, adheres to the Code of Ethical Conduct, and is in compliance with laws and regulations.

Medium- and Long-Term Goals



We continue to streamline the internal and external personnel reporting pipelines and implement a whistleblower protection system.



An independent third-party opinion statement is issued annually as a basis for improvement.

2022 Goals



We will gradually move from the vendor side to the customer side to establish the terms of the integrity pledge, implement the mutual integrity pledge with customers, and continue to strengthen the legal compliance system.

95%

We regularly promote Standards of Integrity Management & Business Conduct and require 95% of our employees worldwide to attend at least one training session.

2022 Achievement Status



For contracts with customers or vendors, we are committed to establishing mutual integrity pledges and requiring suppliers to sign the pledges. In 2022, no vendor refused to sign.

25,011

We continuously and regularly promote policies related to the SBC, and conduct online training courses for employees around the world to promote employee awareness of compliance with regulations. By 2022, we have trained 25,011 employees worldwide.

2023 Goals



New vendors are required to sign an integrity pledge, and we will continue to promote the establishment of integrity pledges from the supplier side to the customer side to strengthen the regulatory compliance system.



We will strengthen our policies on integrity and business conduct, anti-bribery and anti-corruption, and continue to conduct regular training programs for our global employees.



We will continue to increase the proportion of female directors.

Corporate Governance Structure

Acer Corporate Governance Blueprint

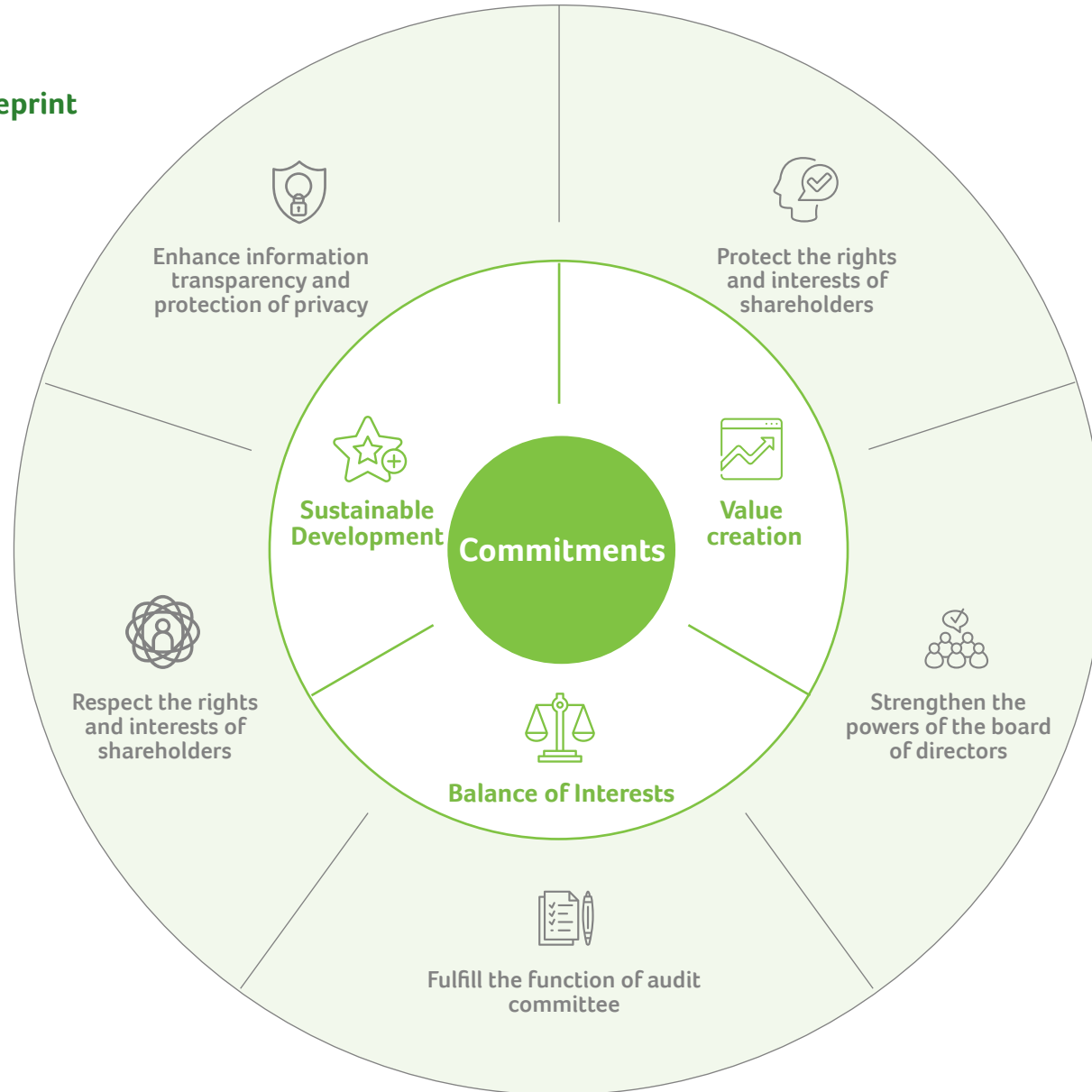

Regulations



- Articles of Incorporation
- Ethical Code of Conduct
- Sustainability Report
- Rules of Procedures for Shareholders Meetings
- Rules Governing the Exercise of Rights and Participation in Resolutions by Juristic Person Shareholders with Controlling Power
- Internal Control System



- Rules of Procedure for Board of Directors Meetings
- Procedures Governing Election of Directors
- Continuing Education for Directors
- Responsibilities and Duties of Independent Directors
- Audit Committee Charter
- Remuneration Committee Charter
- Assets Management and Handling Committee Charter
- Other Functional Committee Charter



- Regulations of Finance and Business of Subsidiaries
- Management of Transactions with Affiliated Persons
- Disclosure for Material Inside Information & Merger & Acquisition Information
- Procedures Governing the Acquisition and Disposal of Assets
- Procedures Governing Loaning of Funds and Making of Endorsements/Guarantees
- Procedures for Derivatives Trading
- Principles of Antitrust and Fair Competition
- Rules Governing Insider Trading
- Rules Governing Internal Auditing
- Gender Equality & Personal Data Protection

Board of Directors and Committee

Acer insists on transparency in its operations, with a focus on stockholder rights, and believes that a healthy, effective board of directors is fundamental to a strong company.

To continue to strengthen corporate governance and to respond to the policies of the competent authorities to promote corporate governance, Acer has established the Company's Corporate Governance Best Practice Principles with reference to the "Corporate Governance Best Practice Principles for TWSE/TPEX Listed Companies" and the OECD Corporate Governance Principles. With regard to the everyday business of Acer (including finances, the environment, and social matters), all matters, with particular specified exceptions, are to be handled in accordance with the decision of the board. In order to ensure that actions are consistent with the results of board discussions and that investors are aware of how the board is exercising its authority, attendance of board meetings is disclosed in the company's annual reports. The company shall also set up full- or part-time corporate governance units or personnel to be responsible for relevant matters and designate senior executives to supervise them.

The Board of Directors holds meetings at least once a quarter to review corporate performance. In accordance with the Company's Rules for Board Meetings, it discusses major investment agendas, future development strategies, and reviews important ESG strategic issues and key milestones, including legal, economic, environmental and social impacts, risks and opportunities, and information security issues. In 2022, 6 board meetings were held and 37 ESG-related motions were proposed, of which 4 were related to ESG issues in general, 18 to corporate governance, 6 to environment and 9 to society.

Under the auspices of Acer's Board of Directors are three committees: the Audit Committee, the Remuneration Committee, and the Investment Review Committee. Each of these operates under its own set of guidelines and standards: the Audit Committee Charter, the Remuneration Committee Charter, and the Investment Review Committee Charter respectively. It is expected that these committees will provide mutual supervision and assistance alongside the Board of Directors, further strengthening investment, setup, and M&A decisions while also improving overall corporate governance capability.

Corporate Governance Structure of Acer Inc.

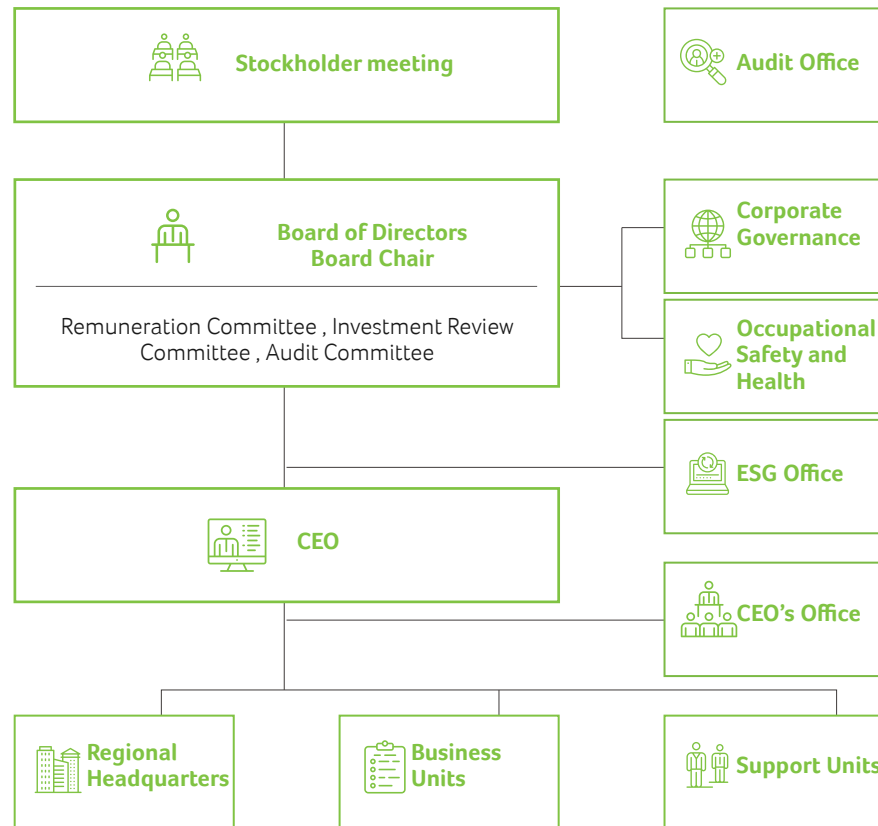

Board of Directors and Committee

- Board of Directors**

Direct corporate strategy, oversee management, and are accountable to the company and stockholder meeting

- Audit Committee** (Composition of 100% independent directors)

Oversee the proper presentation of the company's financial statements, the hiring/dismissal of CPAs and ensuring their independence and performance, the effective implementation of internal controls, company compliance with relevant laws and regulations, and the management of existing or potential risks to the company.

- Remuneration Committee** (Composition of 100% independent directors)

Formulate and regularly review the policies, evaluation and remuneration of directors and managers, and regularly evaluate and set remuneration of the aforementioned personnel.

- Investment Review Committee**

Review new investment, joint venture, M&A, and strategic investment plans in advance, then submit proposals to the Board of Directors for approval; may execute the Board of Directors' resolutions on investment and other authorized matters.



Nomination and Election of Directors

As such, in addition to being qualified and experienced, board members not only must adhere to relevant legal requirements, they are also held to exceptionally high professional standards. Candidates for Acer directorships are elected at the stockholder meetings and have all previously served in major positions with well-known companies, law firms, or other related industry positions. They are expected to have a wealth of experience with commerce, finance, accounting, law, and corporate operations. Directorships also span a range of nationalities, cultures, genders, and age groups, in order to strengthen the diversity of the board of directors, oversee the company's operational decisions, implement corporate governance, and improve operational quality. For details, please refer to [page 16-19 of the Acer's 2022 Annual Report](#).

Board Diversity and Independence

The current Acer's Board of Directors is made up of seven directors who, in accordance with the law, will hold their positions for three years, a term running from June 12, 2020 to June 11, 2023. More than two-thirds of the board members do not hold managerial of those Board members, four are independent directors, accounting for 4/7 of the Board of Directors, or more than one half, resulting in the current board even more independent. In terms of age brackets, the current Board is composed of 2 directors between 40 and 49 years old, 4 directors between 60 and 69 years old, and 1 director between 70 and 79 years old (See [page 16-19 of Acer's 2022 Annual Report](#)). Such a makeup ensures that the experience of these veterans can be more fully passed down and integrated with the dynamism of the next generation.

Acer has also revised the Rules for Board Meetings that deal with conflicts of interest. In accordance with these rules, Directors or their legal representatives are expected to clarify their interests, and should there be a conflict of interest with that of the company, said Directors may neither participate in discussions or votes, nor serve as a representative of another Director in exercising their right to vote. Additionally, should an independent director oppose or express reservations on the record and/or in writing about any issue resolved by the board, this should not only be recorded clearly in the minutes, but also be reported within two days of the meeting through the reporting website specified by management. For details, please refer to [page 37-40 of the Acer's 2022 Annual Report](#).

Performance Evaluation of the Board of Directors

In December 2022, Acer completed its Board of Directors performance evaluation. This evaluation included self-evaluations in areas including the makeup and structure of the board, board participation in corporate operations, improving board decision quality, internal controls, and director elections and ongoing improvement thereof. Each director also gave suggestions of which issues should be priorities for the board in the coming year, helping the board's continuing operation and overall performance. In order to implement its sustainable development policy, the company also reviews the involvement of directors in economic, social, and environmental issues through performance evaluations, as well as regularly communicating with dedicated units on economic, social, and environmental issues, receiving reports, reviewing implementation status, and evaluating risks. To maintain the professional strengths and competencies of the directors, all seven directors have participated in various continuing education courses, including "Corporate Governance and Securities Regulation", "How can business leaders lead low-carbon ESG transformation initiatives?", "Observations on Cross-Strait and World Situation after the 20th National Congress of the Communist Party of China", "New Order of Global Shipping and Logistics", "New Knowledge on Tax and Securities Laws", "Insights and Outlook on Global Economic and Financial Situation" and "Fraud Risk Management and Integrity Management" in 2022. The average number of annual continuing education hours for current directors is 10.07 hours, [See page 58-59 of Acer's 2022 Annual Report](#).

[Directors' Performance Evaluation Results for 2022](#)

Board of Directors and Committee Members and Meeting Attendance in 2022

Position on Board	Director Names	Gender	Board of Directors	Audit Committee	Remuneration Committee	Investment Review Committee
Chairman	Jason Chen	Male	○			○
Director	Stan Shih	Male	○			○
Director	Hung Rouan Investment Corp. Representative: Maverick Shih	Male	○			
Independent Director	Simon Chang San-Cheng ^{Note}	Male	○	○	○	○ Chairperson
Independent Director	Bruce Ji-Ren Lee	Male	○	○	○	○ Chairperson
Independent Director	Charles Ching-Hsiang Hsu	Male	○	○ Chairperson	○	
Independent Director	Yuri Kure	Female	○	○		○
Number of Meetings in 2022			6	6	4	4
Average Attendance Rate in 2022			95.2%	91.7%	91.6%	100%

Note: He resigned on December 16, 2022 due to his election as the third mayor of Taoyuan City.



| Ethics/Standards of Conduct & Legal Compliance

Remuneration Policy for Directors and Senior Management

Acer's remuneration policy for directors and senior executives is designed to align with corporate governance principles, ensuring that their compensation reflects market standards, contributions, and responsibilities, while considering individual performance, company performance achievements, and risk control. This policy embodies the company's values and commitment to sustainable business as its ultimate goal.

Recipients: According to Acer's "Remuneration Principles to Directors," directors who also serve as executives are excluded from director remuneration to avoid duplicating payments and rationalize the allocation of company rewards, ensuring Acer's long-term development.

Encouraging diversity: Acer's "Remuneration Principles to Directors" also stipulate that directors are entitled to fixed remuneration. Besides acknowledging their roles and participation in meetings, this provision encourages directors to provide opinions based on their professional expertise without affecting their fixed remuneration. This allows the Acer Board of Directors to embrace diverse perspectives and promote the company's sustainable development.

Maximum director remuneration limit: In profitable years, after paying taxes, offsetting losses, and setting aside relevant reserves in accordance with the law, Acer's bylaws establish a cap on director remuneration, not exceeding 0.8% of the net profit. This measure prevents excessive director remuneration and strengthens the company's ongoing development.

Alignment with ESG goals: The remuneration policies of the top governance body and senior management are closely linked to Acer's ESG goals. In recent years, Acer has responded to ESG strategies by introducing environmentally friendly products such as the Vero eco-friendly laptop made from recycled plastic, the Acerpure Pro Vero air purifier that reduces carbon emissions by 20%, and the energy-efficient ebii bicycle. These products represent Acer's commitment to environmental protection and sustainability. The quality and performance of these products are directly linked to the remuneration of various management levels, including the variable remuneration of the top governance body.

Demonstrating commitment to sustainability: We believe that extending the remuneration contracts of the top governance body and senior management over longer terms can align their interests with long-term shareholder interests. According to the decision made in the 15th item of the 4th Board of Directors meeting on November 4, 2020, the long-term incentive plan for executives (grade B02 and above) has a three-year duration, with the annual individual stock allocation calculated as one-third of the quota. This demonstrates the commitment of senior management to the company's long-term operational performance.

Corporate Legal Compliance

Standards of Integrity Management & Business Conduct

The "[Standards of Integrity Management & Business Conduct \(SBC\)](#)" is the highest standard of business ethics for all Acer management, employees and business partners. The content of the SBC follows the guidance of government agencies and international treaty declarations on operating with integrity and respecting human rights. It incorporates many issues that have been important to ESG in recent years, social media interaction rules, and industry violations. With the consensus of the legal, human resources, and auditing units, we have jointly established [Procedures for Handling Incident Notification](#) so that employees can follow and prevent recurrence. These standards provide fundamental guidance and instruction to staff for interactions with customers, business partners, shareholder, and the community. They are built around Acer's core values of passion, user-orientation, innovation, teamwork, balancing interests, and integrity. They serve as detailed guidelines for decision-making and action with regard to fair competition; respect for the environment; intellectual property rights; conflicts of interest; the prohibition of improper payments, gifts, or hospitality; political contributions and activities; and so forth.

Zero Tolerance for Corruption

Acer strictly requires all units to comply with the "[Acer's Anti-Bribery and Corruption Policy](#)", and a corruption risk assessment was proactively undertaken. Acer also sent a letter to suppliers and customers stating its anti-corruption stance, requesting that no improper benefits such as gifts, hospitality or money be offered to Acer employees, and that this be supported by the signing of an integrity pledge. In addition, to protect the rights and interests of stakeholders and promote communication with stakeholders and strengthen corporate governance, anyone who discovers that an Acer employee is suspected of fraud, corruption, or any illegal activity or violation of corporate governance shall file a report or complaint directly through the designated email address (whistleblower.acer@acer.com). Board members have also received training on anti-corruption during their term of office, with a percentage of 100%. There were no terminations or non-renewals of contracts with business partners due to corruption violations in 2022.

Region	Senior executives	Middle-level/ Frontline managers	Employees	Total
Taiwan Region	39	407	1,596	2,042
Asia Pacific	7	242	905	1,154
Pan-America	4	53	27	330
China Region	-	1	14	15
Total	50	703	2,788	3,541

Note 1: The EMEA Headquarters will conduct anti-corruption training in 2023.

Note 2: In 2021, anti-corruption training was conducted as a dedicated single course, allowing for the display of the number of participants and the completion rate. However, in 2022, diverse course topics were promoted, such as "Standards of Integrity Management and Business Code of Conduct" and the "Anti-Corruption" module in the training for new employees at each operations headquarters. Since the training was conducted in multiple thematic courses, there may be instances of duplicate counts in calculating the completion rate. Therefore, only the cumulative number of completed training sessions can be disclosed.

Note 3: The senior executives in the China region are currently held by the senior executives from the headquarters.

Anti-Trust

Acer Group has established the "[Antitrust and Fair Competition Principles](#)" and published them on the corporate website. In addition to regular employee education and training every year, we have also produced an animated film for anti-trust and fair competition internal education and training. Through this film, the Company aims to prevent legal risks and negative impacts that employees may incur due to violations of anti-trust and fair competition laws. In 2022, we were not litigated for any anti-competitive, anti-trust, or monopolistic behaviors.

Legal Compliance Status in 2022

- Incidents of non-compliance concerning the health and safety impacts of products and services
- Incidents of non-compliance concerning product and service information and labeling
- Incidents of non-compliance concerning marketing communications
- Receipt of significant fines due to breach of regulations regarding the provision or use of products or services
- Receipt of any fines regarding environmental damage, nor any related disputes
- Receipt of any significant fines or non-monetary sanctions for breaches of the law
- Litigation involving anti-competitive, anti-trust, or monopolistic behaviors

0

In 2022, Acer experienced zero incidents as mentioned above^{Note}

Note: With reference to the "Guidelines for the Recognition of Sustainable Economic Activities" of the Financial Supervisory Commission, the criteria for materiality are as follows:

- (1) where the company incurs a material loss or impact;
- (2) where a relevant authority orders suspension of work, suspension of business, termination of business, or revokes or voids a permit pertaining to pollution;
- (3) where the administrative fines for one single event have accumulated to NT\$1 million or more.

Implementation Effectiveness

[The Standards of Integrity Management & Business Conduct \(SBC\)](#) has been posted on Acer's official website since the date of revision, and the policy is regularly shared with employees' email addresses worldwide. In addition, education and training sessions are held from time to time for new and existing management and employees, so as to ensure that the entire company understands the changes in the company's policies. In order to ensure that the education and training on the changes to the SBC can be implemented despite the spread of the COVID-19 global epidemic, Acer has adopted an online system for training and testing employees worldwide to increase the training coverage under the global trend of working from home and maintaining a safe social distance, and to more efficiently obtain the training and testing rates and parameters of employees for analysis.

Education and Training Statistics for 2022^{Note}

(Unit: Attendance)

Region	Standards of Integrity Management & Business Conduct	Zero Tolerance for Corruption	Anti-Trust	Labor Rights
Taiwan Region	11,234	2,042	177	2259
China Region	2,369	15	6	-
Asia Pacific	5,252	1,154	27	45
EMEA	4,086	-	-	26
Pan-America	2,070	330	61	212
Total	25,011	3,541	271	2,542

Note: Undisclosed figures indicate that this training will be held at the operational Headquarters in 2023.



Internal Audit

Acer has an internal audit office, which is an independent unit under the Board of Directors, to ensure that the Company and its employees are operating with integrity, adheres to the Code of Ethical Conduct, and is in compliance with laws and regulations. Its operations cover the following:

- **Internal Audit**

The internal audit office conducts audits in accordance with the annual audit plan approved by the board of directors and performs project audits as necessary. The audit targets include the Company and its global subsidiaries, and their scope covers financial, business, and other corporate operations and management functions. Audit results and subsequent improvement plans are reported to the Board of Directors and management periodically in order to prevent fraud and drive for growth.

- **Risk Assessment**

Risk assessment is conducted annually using a multi-factor risk factor, which includes both financial and non-financial measures towards key operating subsidiaries worldwide. Financial-oriented evaluation includes changes in revenue, expenses, profit and other trends; non-financial evaluations include, but are not limited to, key control points in procurement and sales, system changes, management team changes, internal and external expert opinions, operational procedures and locations involved in whistleblower reports over the years, and the Global Corruption Country Assessment Index. Internal audits are conducted on a case-by-case basis to evaluate the risk factor, and the final results are used to select high-risk operations for annual internal audits.

- **Internal Control Self-Assessment**

Acer's units and subsidiaries review their business practices in accordance with the law and company policies and regulations through the annual Control Self-Assessment mechanism. They are also subject to review by internal audit office.

Reporting and Protection

Acer has established the "[Stakeholder Grievance Mechanism](#)" and the "[Anti-Bribery and Corruption Policy](#)", set up a multiple reporting and grievance mechanism, listened to voices from both internal and external sources through open channels, and protected the rights and interests of stakeholders and strengthened corporate governance. The internal audit office serves as the liaison window for complaint reporting and handling within Acer. (For more information, please refer to: [Stakeholder Grievance Mechanism](#))

Once any violation of the SBC or the law has been reported, it will be promptly investigated by the authorities responsible for verifying its authenticity. If the complaint is substantiated and a violation is found, Acer will immediately take appropriate action, require the offending employee to cease such conduct, and take legal action as necessary to protect Acer's rights and reputation. Furthermore, Acer will assemble the relevant departments, including human resources, legal affairs, and internal audit office, to review the relevant procedures and discuss feasible corrective measures in order to achieve full internal control of the Company.

Reporting and Complaints Mechanism

- **Channels for Reporting and Complaints**

Reporting and Complaints (whistleblower.acer@acer.com)
 Complaints of workplace sexual harassment or bullying (2645.7085@acer.com)
 Employee Engagement Reflections (acer.corporate.compliance@acer.com)
 Written/email/oral reports or complaints

- **Expected User(s)**

Acer's directors, officers, and employees (collectively, Acer personnel), customers, suppliers, investors, and communities

- **Occasions for Use**

When an Acer employee is found to be involved in fraud, corruption, violation of Acer's Standards of Integrity Management & Business Conduct, any wrongdoing or violation of corporate governance, or when threatened with sexual harassment or bullying in the workplace

- **Promotion of Channels for Reporting and Complaints**

A dedicated email address as set up on the company website
 Internal network (My Acer) announcements
 Occasional announcements about report/complaints mechanisms
 Anti-corruption statements and reporting channels for complaints are amended to the contract with the vendor.
 Annual integrity letters signed by partners
 New staff training and education/Supplier conferences



Stakeholder Grievance Mechanism



Procedures for Handling Reports and Complaints

- 1 Upon receipt of a report or complaint, Acer's internal audit supervisor will, depending on the content of the report/complaint, assemble the appropriate legal/HR personnel to form an investigation team and conduct an investigation in a confidential and rigorous manner.
- 2 All complaints received by Acer's internal and external reporting channels, whether anonymous or named, are properly recorded and tracked.
- 3 We take appropriate protection measures for those who report in good faith or participate in an investigation to avoid any form of retaliation against them and provide timely feedback to the complainant on the progress of the case.
- 4 Internal audit supervisor compiles reports/complaints and report investigation process and progress (including whether they are substantiated, unsubstantiated, or under investigation) to the Audit Committee and the Board of Directors on a quarterly basis.
- 5 Based on the investigation results, we will take corresponding improvement measures to prevent the recurrence of similar cases.
- 6 The internal audit office also regularly investigates and collects reports and complaints from each subsidiary to review the content of the reports, the results of their handling, and improvements to internal control management measures.
- 7 The number, type, and outcome of reports/complaints are publicly disclosed in the Sustainability Report each year.

Results of Handling of Reports and Complaints

In 2022, Acer received 16 reported complaints, 7 of which were related to violations of the Standards of Integrity Management & Business Conduct. After investigation, a total of 4 cases were substantiated. Please refer to the following table for details of the cases and their subsequent handling.

	2018		2019		2020		2021		2022	
Investigation Results	Unsubstantiated	Substantiated	Unsubstantiated	Substantiated	Unsubstantiated	Substantiated	Unsubstantiated	Substantiated	Unsubstantiated	Substantiated
Total Number of Reports Received	4	3	7	11	2	12	6	12	7	9
Violation of the Standards of Integrity Management & Business Conduct	4	1	7	4	1	6	4	4	3	4
Unrelated to violation of the Standards of Integrity Management & Business Conduct	0	2	0	7	1	6	2	8	4	5
Friendly Workplace Environment/Sexual Harassment	0	2	0	3	0	4	0	1	2	3
Staff Working Rules	0	0	0	3	0	1	1	1	1	0
Other / After-sales Service	0	0	0	1	1	1	1	6	1	2

Important Case Categories	Case Overview	Result of Handling
Violation of the Standards of Integrity Management & Business Conduct	The outsourced employee falsified travel and accommodation invoices to request payment from the accounting unit, so as to over-claim the amount.	The staff concerned has been dismissed and his improper gains recovered
	Regional sales executive manipulated dealer prices and took advantage from specific dealer to make personal gains.	Dismissed the regional sales executive involved in the case after investigation Restate the Code of Business Practice to internal and external related parties Arrange for random checking by a third party to prevent similar cases from recurring
	Sales staff forged customer orders, including changing quantities, warranty conditions, sales prices, and other violations.	After investigation, the sales staff has been dismissed.
	The sales staff set up an outside company without disclosing to the company and obtaining permission in accordance with the working rules.	After investigation, the sales staff has been dismissed.
Sexual Harassment	A total of three cases were filed in which the respondents harassed the complainants with verbal and physical actions.	After investigation, we have dismissed the three employees whom have been complained against, to demonstrate the company's zero tolerance policy towards workplace bullying and harassment.
After-sales Service	A total of two cases, consumers responded that the efficiency of product maintenance and parts replacement is too low, causing inconvenience.	The after-sales service unit has reached an agreement with the consumer and handled the matter properly.

Risk Management

Acer's corporate philosophy is based on the ultimate goal of "sustainable development." We believe that rigorous and pragmatic risk management not only reflects Acer's persistent commitment to our customers, employees, supply chain partners and investors, but also to our long-term commitment to ensuring sound business performance and compliance of corporate social responsibility. It is also a concrete act of ensuring sound business performance and fulfilling corporate social responsibility. The relationship between sustainable corporate development and risk management is intricate. Only by continuously identifying and analyzing the short-term dynamic changes and long-term trends of risks and implementing relevant risk management strategies, and by establishing a risk-conscious corporate culture through frank internal communication and training programs, can we ensure our hard-earned business results and achieve our goal of "sustainability."

To realize the vision of sustainable development and establish a risk-conscious corporate culture, the Company not only follows the relevant risk management measures under the organizational management system and operational processes at all levels, but also commits to continuously improve the Company's risk management practices through the participation of senior managers, using international standards such as ISO 31000:2018 risk management system and the Corporate Risk Management Integrated Framework (COSO ERM 2017) issued by the National Council on Fraudulent Financial Reporting (NCFR) as references. The Company will continue to improve its risk management practices through the participation of its senior management, and will establish a risk management policy based on international standards such as ISO 31000:2018 risk management system and COSO ERM 2017, which was approved by the Board of Directors on March 16, 2022.

Acer takes a proactive and cost-efficient approach to manage risk. The risk management scope is based on strategic, operational, financial, disaster and climate change risk components, and regular overall assessment of the internal and external business environment (external business environment assessment includes various external international risk reports and relevant reports/research results of the insurance industry/risk management consultants for the purpose of assessing the integrity of risk perception) and establishing a risk radar.

The Acer Risk Radar for 2022 identified 19 internal risks and 26 external risks, totaling 45 risks, through the aforementioned process. Risk Prioritization and Risk Appetite are conducted for the purpose of business growth and effective resource allocation, and corresponding risk management strategies and preventive/mitigation measures, implementation mechanisms and responsible organizations are formulated to ensure that the relevant key risks are effectively controlled and responded to appropriately. To continuously monitor and strengthen risk management practices and response measures, the Audit Committee evaluates and incorporates them into the regular agenda based on the importance and urgency of the risk ranking, and decides on the reporting issues and the responsible units. The Audit Committee regularly summarizes the risk environment, risk management priorities, risk assessment results and related countermeasures together with information security risk management implementation in the Board of Directors' report (at least once a year).

Scope of Acer Risk Management

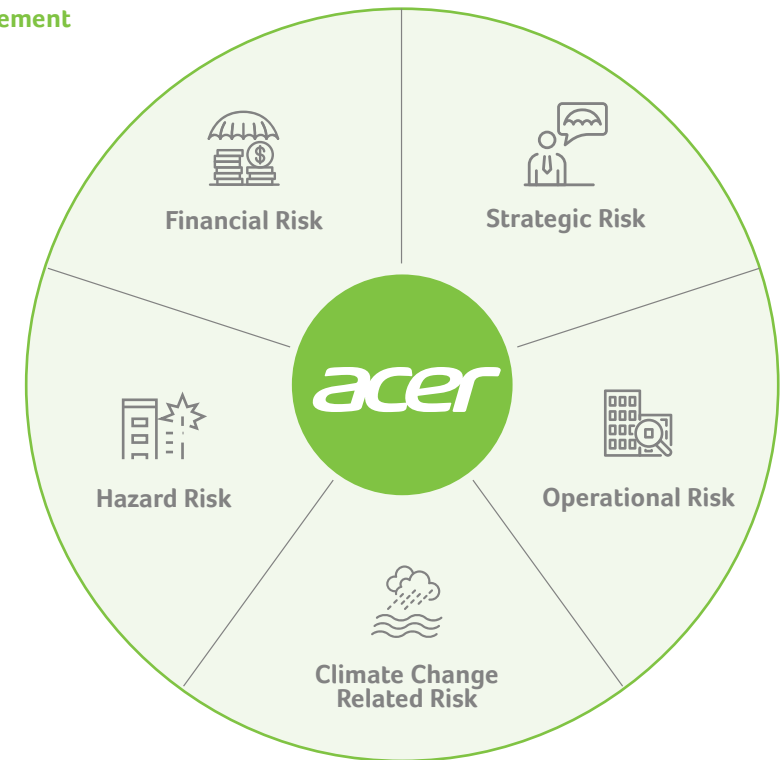

| Acer Risk Management Organization Structure

Organizational History

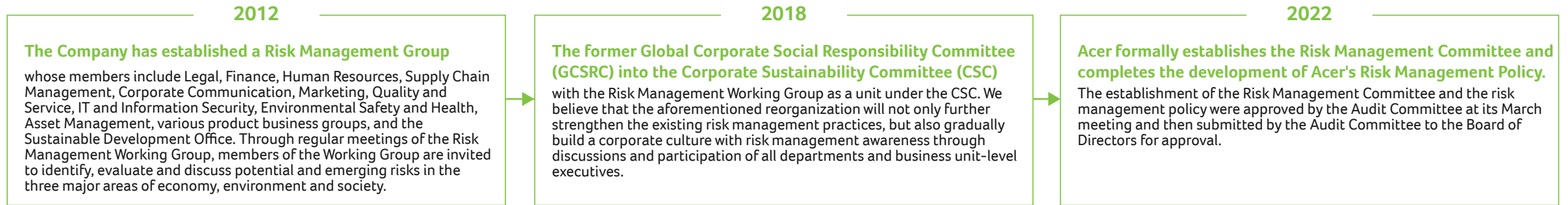

2022 Acer Risk Management Operations Status



Acer Risk Management Organization Chart

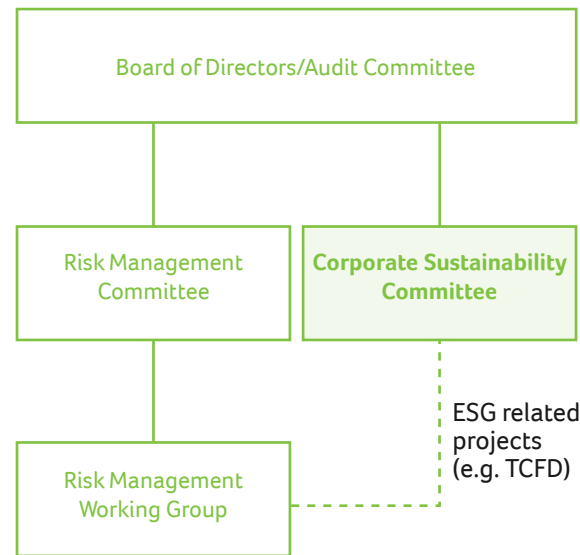

Responsibilities of the Acer Risk Management Organization

- Board of Directors/Audit Committee**
The highest authority for risk management of the Company
 Promote and implement the Company's overall risk management policy in accordance with the overall operating strategy and business environment to ensure effective risk management
- Risk Management Committee**
 Composed of the top executives of each business unit/functional organization in the headquarters, with the chief of internal auditor as observer
 Reports to the Audit Committee and Board of Directors
 Summarize the risk environment, risk management focus, assessment results and related remedial measures
 Guide and approve the priority of risk control
 Supervises ongoing improvement of risk management
 Observers regularly review the implementation of risk management policies
- Risk Management Working Group**
 Composed of representatives of divisional directors of each business unit/functional organization
 Identifies risks, assesses potential risk scenarios and operational impacts
 Plans and implements risk prevention and mitigation actions based on risk scenarios
 Integrate corporate risk management reports and report to the Risk Management Committee
 Continuous refinement of risk management practices and effectiveness
 Establish and rehearse crisis management-related operational procedures



| Risk Management Procedures

Three Layers of Defense Structure for Risk Management Organization

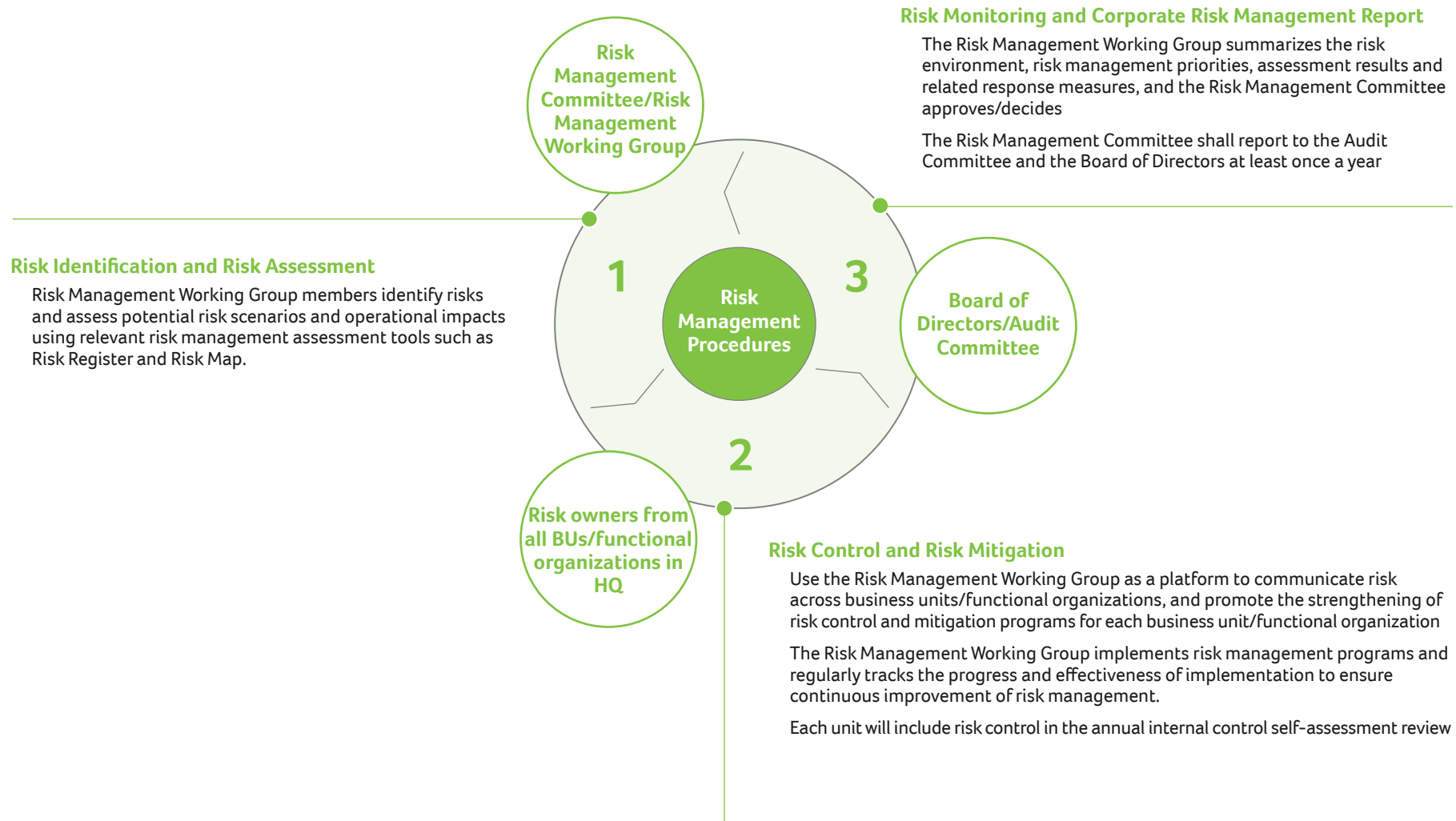

Three Layers of Defense Structure for Risk Management Organization





| Risk Identification and Management Effectiveness in 2022

The Company identifies, evaluates and discusses potential and emerging corporate risks in three major areas: environmental, social and corporate governance. Risk management organizations use the Risk Map to assess the potential threat level of each risk to the company's future operations based on the likelihood of occurrence of each risk and the degree/severity of loss that may be caused once the risk occurs, and to prioritize risk management strategies by classifying the risk level. We also use Sensitivity Analysis and Stress Test to further quantify and analyze the risks and examine whether there is a high correlation between the risk factors. The Risk Map for 2022 includes six risk items with a medium to high level, including geopolitical risk, information security risk, inventory risk, ICT market downside risk, downtime/operational disruption, and ESG-related risk (Refer to the 2022 Risk Map for details).

The Risk Management Working Group compiles the results of the aforementioned analyses and tests, draws up a follow-up implementation plan, and reports them to the Risk Management Committee on a regular basis (quarterly); in 2022, the Risk Management Working Group has a total of 16 departments/units to coordinate with. To integrate the implementation of ERM with the daily operation procedures of each department/unit and the Business Objective, each department/unit first compiles 46 Key Performance Indicators (KPIs) and then develops/identifies 82 Risk Scenarios that may actually cause operational impacts on the aforementioned KPIs. Based on the identified and analyzed risk items, the relevant department staff are assigned to prepare the subsequent risk management strategy and related implementation plan (Risk Mitigation), including the common risk management responses in practice: Loss Prevention, Avoidance, Separation & Duplication, Transfer and Retention. Duplication, Transfer, and Retention, etc., and evaluate the appropriate resource input, implementation priorities, and follow-up progress tracking methods. At the same time, we have developed the Incident Response and Crisis Management plans to minimize the negative impact of potential risks on our business objectives and to strengthen the risk resilience of our overall operations. The aforementioned risk management strategy and related implementation plan are based on the cycle of Plan, Do, Check, and Action, and the effectiveness of the risk management plan and the room for improvement are reviewed periodically during the working group meetings for continuous adjustment/refinement. Finally, progress reports on material risk information and corporate risk management operations are made regularly to the Risk Management Committee and the Audit Committee.

In summary, we continue to actively engage in risk management activities with a proactive approach to address current and future risks and challenges in a prudent manner. The Audit Committee also response measures, which are reported by the Chairman at the Board of Directors' meeting.

2022 Risk Map

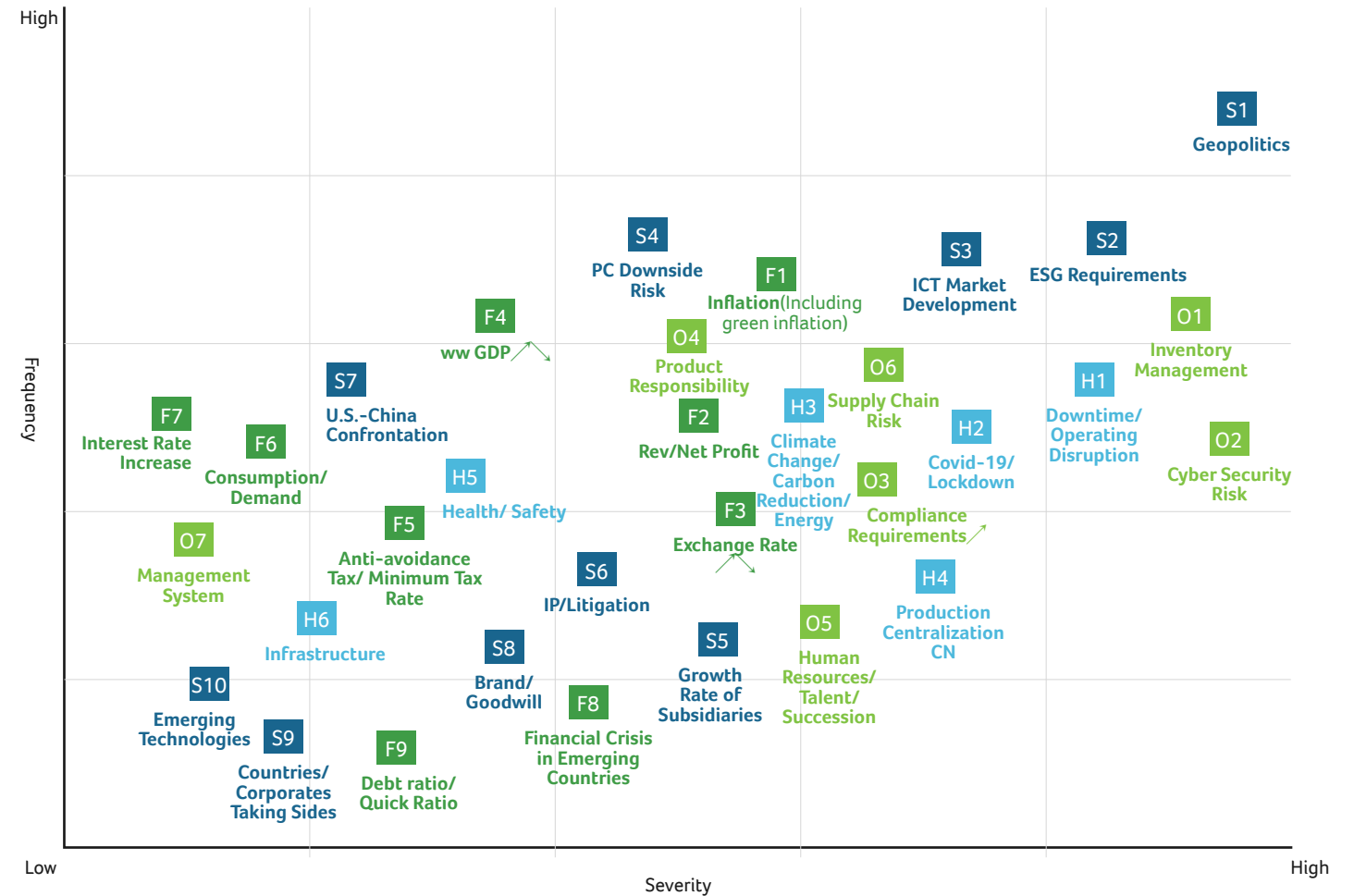

Note 1: The risk identification/analysis process is initiated in the 4th quarter of each year and completed in the 1st quarter of the following year.
 Note 2: The Risk Map is based on the risk level assessment of the risk items in 2022.
 Note 3: Materiality analysis is part of the ERM integration process. Therefore, ESG-related risks, compliance requirements and human rights-related risks have been incorporated into the risk identification/analysis/ranking/control measures process.
 Note 4: Risk item codes (S)-strategic risk, (O)-operational risk, (F)-financial risk, (H)-hazard risk; the numbers represent the serial numbers in the risk register and are not related to the risk level.



| Emerging Risks

The Risk Management Working Group has identified emerging risks such as information security risks, extreme climate risks, large-scale infectious diseases, supply chain-related risks and geopolitical risks in 2021. After regular reconsideration and review in 2022, the Risk Management Committee and Working Group identified a number of emerging risks in 2022, including **geopolitical risks (including geo-economic), ICT market downside, inventory management, inflation (including green inflation), interest rate increase, and global climate change**. Through group discussions and focused thinking, we hope to carefully assess the potential negative impact of each emerging risk item on the company's future operations, and to consider and structure feasible and cost-effective risk management action plans for registration in the risk analysis/registration worksheet. Cyber Security Risk continues to be a key risk concern for the Company, especially considering the risk correlation between geopolitical and global economic environment and cyber security risk.

The Risk Management Working Group summarizes possible loss types (including loss of goodwill, business interruption, data leakage, ransomware, etc.), and the IT department has also compiled the following basic information security principles and continues to work on them to obtain ISO 27001 international certification for information security in 2020.

In addition, Acer has continued to purchase global information security insurance policies since 2018 and regularly reviews the integrity of the overall coverage every year. In addition to risk transfer considerations, Acer also expects to obtain further assistance and resources from external information security experts through the international information security insurance market. With the rapid development of information technology, the trend of digital transformation and the continuous investment in various innovative applications, we will continue to pay attention to the development trend of cyber security risks (e.g., cyber security risks arising from the adoption of remote working mode) in order to continuously review and improve the relevant information security principles and appropriate risk transfer measures.

- Reviewing external services that are open to the public
- Using the least privilege principle and encryption
- Verifying and securing endpoints
- Considering the security of the application
- Educating users
- Identifying and protecting the weakest points
- Keeping up with the latest information security regulations and understanding the latest attack techniques

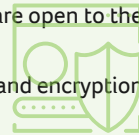

The future trends and potential negative impacts of geopolitical risks (geo-economics), such as country-to-country trade protectionism, related barrier measures and economic and financial sanctions. The Risk Management Working Group collects and summarizes possible loss patterns (including a decline in sales volume or market share due to political and economic instability, or an increase in labor and other related costs due to the relocation of production bases). We will closely monitor the long-term development trend of related risks and their subsequent impact, and make efforts to integrate upstream components with diversified suppliers, and continue our efforts to develop new niche markets and sales channels in order to diversify operational risks and reduce the impact and uncertainty caused by changes in supply chain, logistics and global political and economic conditions.

Acer continues to focus on the long-term trends and threats of global climate change and extreme weather phenomena, and has formally introduced the Task Force on Climate-Related Financial Disclosures (TCFD) assessment framework in 2020.

Currently, the supply chain management department assesses the potential low-temperature variation during the shipment period for a specific shipment route and, depending on the type and characteristics of the product, consults with the insurance industry/risk management consultant to discuss and cooperate with the shipping company to take feasible and cost-effective damage prevention measures. For infrastructure service interruptions and other operation-related risks (e.g., typhoons, floods, fires, etc.) with a high probability of occurrence, similar to the impact of the Texas snowstorm, Acer has started to develop a basic emergency response/business continuity management plan (IR/BCP) for global warehousing locations in 2021. The Company started with a pilot project at the Taiwan headquarters (the project was completed in January 2022 and the on-site exercise and validation were completed at Acer's Taoyuan warehouse), with a view to gradually evaluating and incorporating the implementation/improvement and regular audits according to the current resource situation at each global warehouse location, or further incorporating it into the evaluation items for the selection of warehouse service providers, in order to gradually and orderly strengthen the risk resilience in warehouse logistics management.

Information Security and Privacy Protection

Information Security

Indicators related to GRI/SASB
GRI 418-1

Policies/ Commitments

We maintain the ISO27001 information security management system, implement the NIST (National Institute of Standards and Technology), and implement the spirit of PDCA, and ensure that information security is implemented in our daily work to achieve the goal of sustainable management.

Action Plan

To enhance the security awareness of all employees and to improve the compliance and information security structure to meet the needs of customers, we continue to expand the scope of ISMS (Information Security Management System) implementation and gradually introduce the international information security maturity assessment.

Tracking Mechanism

- Information security performance is reported annually to the Risk Committee and reported to the Board of Directors.
- Security performance is regularly reported to the Head of Global IT and an annual management review meeting is held.
- Biweekly information security meetings are held to continue to track and improve related work.

Medium- and Long-Term Goals

We continue to promote information security and customer privacy protection measures to ensure the security of Acer's and our customers' information privacy.

2022 Goals

Include e-commerce systems in the scope of ISO27001 certification

Begin to incorporate EMEA IT into ISO27001 compliance

2022 Achievement Status

The e-commerce system is ISO27001 certified

EMEA IT promotes a key core system to follow ISO27001

Global introduction of MDR (Managed detection and response) threat detection response and compliance detection defense mechanism to significantly strengthen global information security defense capabilities

Establish a global vulnerability management dashboard for real-time monitoring, quickly overview the information needed for risk control, and further develop standards for remediation to reduce risk

Create a global defense and detection dashboard to provide a real-time overview of information security risks

2023 Goals

The core system of EMEA IT passes ISO 27001 certification.

HQ IT continue to pass the revisits of ISO27001 certification.

Comply with the latest version of ISO27001 and revise the ISMS documents to achieve standard applicability and requirements

Develop automation of cloud information security framework

Continuously strengthen and standardize information security policies and processes and implement controls using automated tools to reduce risk

Develop zero-trust network framework

Strengthen information security incident response framework and backup effectiveness to enhance post-disaster recovery efficiency



| Information Security

Information Security Policy

To pursue sustainable business operations and protect customer trust, Acer started to promote a company-wide information security management system in 2019 and has established an information security policy as a basis for information security management to ensure the security of Acer's information assets and the continuity of information services, and to reduce the threat and impact of information security incidents.

This policy covers Acer's information assets, information systems and infrastructure, and applies to all officers and employees of Acer, including contractors, consultants, temporary employees, interns and any other third parties who work for Acer, referred to as employees.

- Ensure that Acer's information assets are protected from any external interference, disruption, attack or any other destructive or negative intent.
- Ensure that Acer complies with its relevant legal obligations.
- Ensure the continuity of Acer's IT services.



This policy framework complies with the EU General Data Protection Regulation (GDPR), the Taiwan Personal Data Protection Act and other relevant laws and regulations, and the requirements of the competent authorities to ensure the collection, processing or use of personal data. We also comply with the U.S. Defend Trade Secrets Act (DTSA) and the Taiwan Trade Secrets Act and other laws and regulations related to copyright, trademark and patent protection. The policy is re-examined at least once a year to ensure the viability and effectiveness of information security maintenance by checking compliance with the legal requirements of the latest technological and business developments.

Corporate Information Security Management Organization

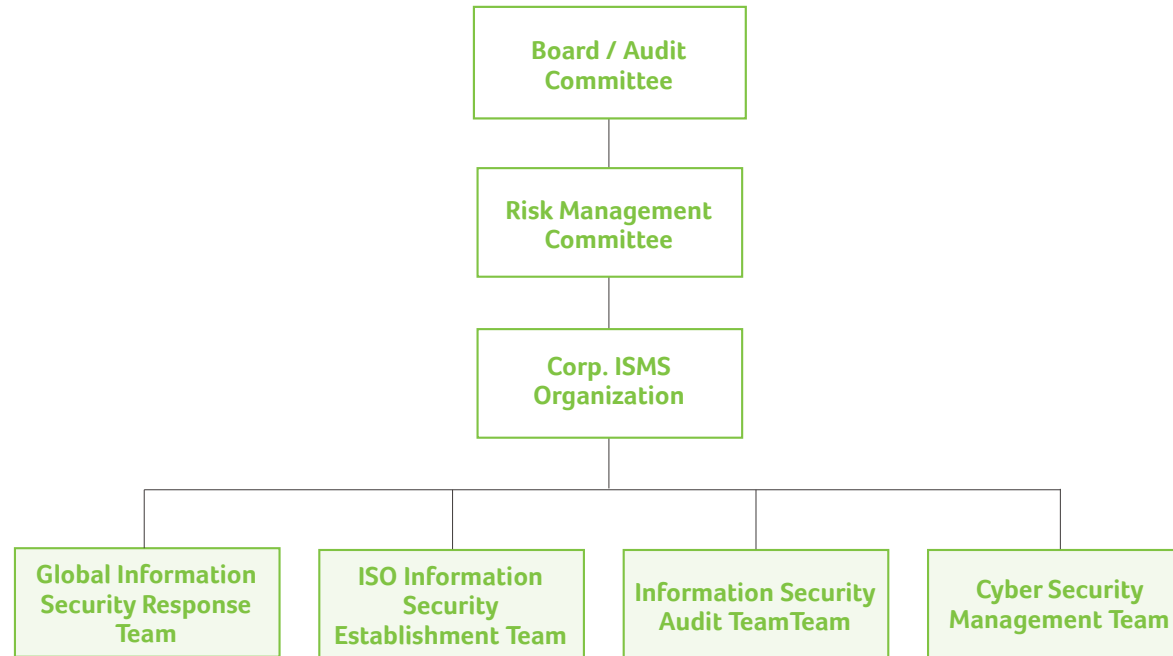

Information Security Policy and Management

As a global brand, Acer considers maintaining information security immensely important, especially with regard to earning and keeping the trust of those investing in the brand, customers, and other interested stakeholders. We continue to work to improve global information security organization and policy, and to coordinate work on the various aspects of information security management systems, to ensure that the Group's information assets comply with relevant laws, regulations, and standards. We also strive to set out the security control measures necessary to protect the Group's information systems and services.

We have established a Global information security management organization, and in accordance with the organizational structure, powers, and responsibilities, jointly worked to maintain the system's sound operation, achieving our goal of stronger information security management. The head of ISMS is the Head of the Global IT and assigns a co-convenor. The head of each division is a member of the information security management organization and assigns representatives to establish the Information Security Management Team, the Information Security Establishment Team and the Information Security Incident Response Team. The information security internal audit team is staffed by the auditing office, and the support team draws from Human Resources, General Affairs, Marketing, Legal Affairs and Finance Departments.

Starting from 2021, Acer has launched the Global Re-architect project, which is expected to take 2 years to re-examine information security and infrastructure across the globe. Acer Taiwan Headquarters completed the ISO27001 review and revalidation in 2022 to ensure that Acer's ISO27001:2013 remains effective and continues to protect the confidentiality, integrity, and availability of information assets by planning, establishing, implementing, and monitoring mechanisms.

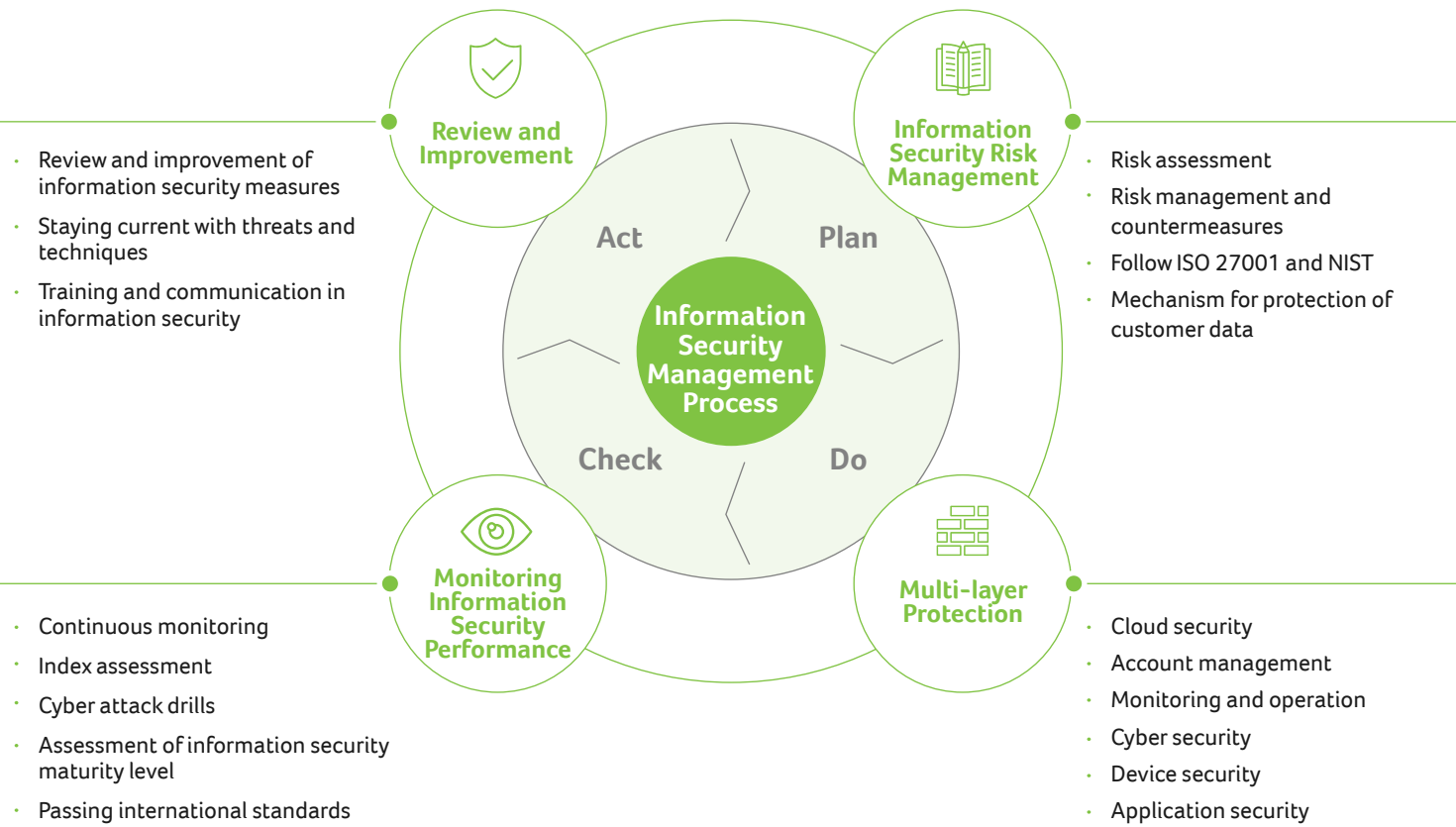

Information Security Management Strategy

- With ISO 27001 as the core framework, Acer established the Information Security Management System (ISMS) and developed global information security practice guidelines to improve, strengthen and implement the policies through information asset inventory, risk assessment, business impact analysis, etc.
- According to ISO 27701, the Personal Information Management System (PIMS) is used to promote the protection and management of personal data to meet the rising demand for personal privacy protection
- Formulated global "Acer Group Personal Information Protection Management Policy" and "Personal Information Management Principles" to implement and conduct the audit accordingly.

Information Security Management Evaluation Mechanism

- Conduct annual ISO27001 third-party certification audits, and arrange regular internal and external ISMS audits, regularly implement information security drills, stress tests, and data recovery drills during non-audit periods
- **Regularly conduct**
Personal data inventory and risk assessment and handling of personal data for equipment security control
- **Occasionally conduct**
Training of personal data processing undertaker, implementation of data security test drills, and supervision of outsourced vendors to comply with personal data protection regulations

Information Security Training

Acer implements personnel training to improve information protection mechanisms and information security management. In 2022, 100% of IT staff completed information training for global IT department employees. We also implement information security training for all employees worldwide, including: passwords, phishing, remote work, ransomware, and business e-mail attacks. In addition, in the second quarter of 2022, the Global Fishing Mail Test was conducted and over 23,000 fishing letters were randomly sent to employees worldwide. 7,669 employees participated in the first half of the year, with 91.4% passing the test; 5,634 employees participated in the second half of the year, with 93% passing the test. Employees who have not passed the course are required to receive additional training courses on phishing to ensure that their information security awareness is enhanced. We also regulate employee information security-related practices in our Standards of Integrity Management & Business Conduct, including compliance, passwords, confidentiality protection, and installed software.

From April to August 2022, in response to the impact of the pandemic, employees on A-B split shifts were diverted to work-from-home without affecting the company's operations through office software such as VPN, Microsoft O365, and Teams.

2022 Corporate Information Security Measures Drive Implementation Results

790,856
vulnerabilities

In 2022, 790,856 server vulnerabilities were detected and repaired worldwide through real-time monitoring systems.

7 times

Over 7 information security promotion announcements were made to communicate important information security requirements and precautions.

88 points

Since May 2022, the average score of the third-party assessment was 88, which is higher than the market average of 83.

12 times

12 vulnerability assessments:
2 sessions of global vulnerability scan
1 session of global web vulnerability scan, detecting over 100 websites
9 sessions of penetration test

2023 Information Security Management Enhancement Highlights

- Assist Acer EMEA IT to achieve ISO27001 certification.
- To maintain best practices for Acer's information security compliance, we will conduct education and training for key members of the organization on the ISO 27001:2022 version changes and revise relevant information security policies and guidelines to fully prepare for the transition.
- To improve the auditor's mastery of the audited system, we plan to create ISMS system profiles for each audited system.
- Automate operations such as information account inventory and asset inventory.
- Strengthen information security control policies, processes and frameworks, and establish standards to identify information security maturity.
- Strengthen network firewall and network control to prevent malware from spreading horizontally across the network through network architecture micro-segmentation.
- Introduce a multi-level control mechanism for privileged accounts to prevent leakage of privileges.
- Introduce endpoint management mechanism to manage, protect and deploy enterprise resources and applications.
- Perform regular information security drills and continuously optimize the mechanism.
- Build cloud information security automation control framework
- Enhance backup effectiveness and provide a recovery solution that can be rebuilt quickly.



In Response to Data Breach Incident

As reported in March 2023, hackers stole 160GB of data from Acer's servers and sold the stolen data in hacker forums. It was found that the server was used by our local business partners to download product files needed for maintenance. Due to improper management, the server was used by an unauthorized person, but no server were vandalized and no personal or customer information was leaked. Daily operations were not affected.

Management Mechanism and Response

We continue to strengthen our information security framework and management to maintain operational continuity and data integrity. We also remind companies and organizations to follow information security principles and to be more vigilant about network anomalies.

| Protecting Privacy

Protecting Privacy

Indicators related to GRI/SASB
GRI 418-1 ; SASB TC-HW-230a.1

Policies/ Commitments

Formulated global "Acer Group Personal Information Protection Management Policy" and "Personal Information Management Principles", and implement and audit them.

Action Plan

Privacy protection is critical to Acer's management responsibilities and brand protection. With respect to customer data protection measures, complaint handling mechanisms, and information security incident prevention, Acer always emphasizes and strengthens its hardware, software, and group members' perceptions and behaviors regarding the security and protection of data transmission across national and regional borders.

Tracking Mechanism

- Carrying out regular personal data inventories and risk assessments.
- Occasional training of personal data processing managers and security control of equipment for handling personal data on a regular basis.
- Implement information security test drills occasionally.
- Monitor the compliance of outsourced vendors with personal data protection regulations occasionally.

Medium- and Long-Term Goals



To implement the global "Acer Group Personal Data Protection Management Policy," we have established a personal data protection management organization at our headquarters and regional operating headquarters (Pan American, Pan Asian, and Pan European) or a network information security organization that is also responsible for data protection, and have established corresponding regulations and enforcement procedures in accordance with the relevant personal data standards and regulations.

2022 Goals



The implementation of the Company's personal information management system is aimed at systematizing personal information management operations and enhancing the functions and orientation of personal information management, records and inquiries.



In addition to strengthening the concept of personal information and privacy awareness through various kinds of publicity from time to time, we further enhance the depth and breadth of the content of education and training on related issues.

2022 Achievement Status



Our personal information management system has been officially launched and used.

14,334

In 2022, a total of 14,334 Acer Group members worldwide have completed personal privacy education training.

2023 Goals

0

Maintain zero significant customer privacy violations.



We continue to regularly educate and provide training on employee privacy, including but not limited to the integration of information security and the promulgation or updating of personal data protection regulations around the world.



Privacy Protection Measures

The protection of personal information and privacy has gradually become a basic human right protected by national legislation and has developed into a universal value, as well as an important part of consumer rights awareness. As a global brand company, customer data protection measures, complaint handling mechanisms, and information security incident prevention are essential to the company's management responsibilities and brand protection, and it is the core meaning of Acer's management to always emphasize and strengthen the security and protection of data transmission across borders and regions, ensuring that customers' personal data is safe and informing customers of the relevant regulations and precautions before accepting equipment for repair. No complaints were received in 2022 about any invasion of customer privacy or loss of customer data or hacking incidents. Please see the [information security](#) section of this chapter for more details on information security breaches in 2023.

Staff	Customers
Before Using Personal Information	
Conduct staff training on personal information protection	Information security, confidentiality commitments or personal data protection clauses are set out in contracts
During the Use of Personal Information	
When employees need to use personal information, they shall apply for approval in accordance with the regulations.	When using or storing your personal information, Acer Group's rules and regulations regarding the use of Personal Data data shall be followed.
After Using Personal Information	
Perform internal audits of personal data management occasionally	

- **All Acer employees are required to carefully protect confidential or proprietary information provided by stakeholders, and our products make use of data security technology.**

Facing the risk of network system cracking or intrusion and the rapid changes in technology, Acer not only reviews the need for customer information requests and strengthens information security measures in parallel with Acer's privacy protection practices, but also continues to apply for information security insurance in order to further protect the privacy of stakeholders.

- **Personal information protection and privacy-related issues are incorporated into the orientation training for new employees**

The importance of personal information protection is promoted and reminded through physical or electronic posters in office areas on a regular basis. The Legal Department and each business unit set up and discuss privacy statements or policies on the websites they operate in order to raise the importance and protection of customers' privacy rights among company members, and conduct education and training courses in response to the implementation and revision of personal data protection regulations around the world.

- **The collection, processing and use of personal information shall be in accordance with the purposes set forth in the internal personal information registration form and to the extent necessary for the performance of business.**

After the stakeholder has indicated that he or she no longer wishes to receive marketing messages from Acer, then he or she shall not be engaged in any marketing activities in any way and shall dispose of the personal information appropriately (e.g., by deleting the personal information from the server or moving it to a system other than the one used to send the marketing communications). In other words, Acer prohibits the secondary use of personal information and monitors and manages the use of personal information.



2022 Implementation Status

Regulatory compliance:

The collection, use and management of personal information are required to comply with local personal information protection laws and regulations, and the basic principle is that the subject of personal information should have the right to know, access, correct and delete their personal information.

Implementation of internal controls and human rights education & training:

- Training on personal data protection and privacy-related issues is provided to new recruits at the time of their employment.
- The collection, processing, and use of personal information must be undertaken in accordance with the company's Principles for the Management of Personal Data, approved by units supervisor, and then sent to the Legal Department and the Information Technology Unit for review.
- In 2022, Acer Group continued to implement global employee personal education training, with a total of 14,334 employees completing it.

Global Employee Personal Training

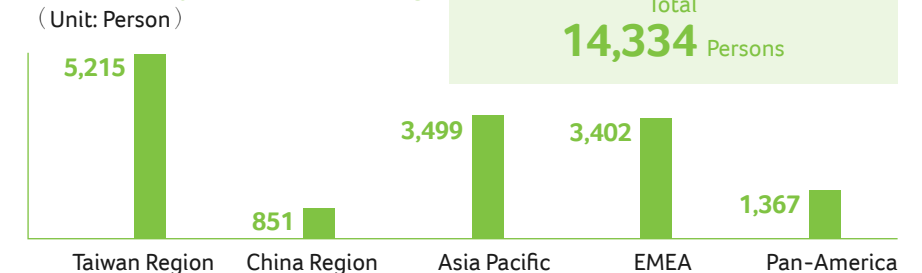

Sound mechanism for handling stakeholder issues:

A proper protection mechanism is in place for personal information involving stakeholders. If there is a suspected security problem or incident involving stakeholder information, the notification mechanism will be activated immediately in accordance with the relevant regulations to ensure that the risk to stakeholders is minimized when it occurs.

Other concrete actions for protection of privacy:

- With respect to the business cooperation between third parties and our customers, this company's customers must also comply with laws on the handling of personal data on the protection of personal information, and that this be clearly laid out in the contract.
- We hold irregular personal information protection related courses for our employees to raise their awareness of personal information protection and to reduce the incidence of any related problems.



| Product Security

Acer is committed to the highest standards of safety in the design of its products and services. To fully protect our customers and their data, we encourage security researchers, academic institutions and other members of the security community to provide any information about potential security vulnerabilities. We work with those who raise major security vulnerabilities to ensure that all relevant reports are handled.

We work with partners, industry and the safety community to address vulnerabilities. When notification of a suspected vulnerability is received, we conduct a thorough investigation and, upon confirmation, we work with the person submitting the issue to remediate and coordinate a public release of the information. Generally speaking, security vulnerabilities are often reported by independent hardware vendors such as Intel, AMD, NV, or Microsoft operating systems (OS) and applications (Apps), and Acer will provide consumers with a way to fix them: we offer a variety of solutions to address security vulnerabilities at community.acer.com. For example, the researchers discovered a vulnerability in the Baseboard Management Controller (BMC), which could lead to the server being hacked to execute any code attack. Acer works closely with vendors to limit risk with best security practices, restrict privileges, and update BMC and CMC firmware to address BMC firmware vulnerabilities that affect certain products.

Acer only uses the latest software versions available on the [website](#) for verification of vulnerability reproducibility. In 2022, we were made aware of seven vulnerabilities related to Acer websites or software through this website, five of which were website related and two were product system related, all of which have been fixed. In addition, we have also published information and solutions on our website based on Intel's Security Vulnerability Announcement.

Acer is committed to ensuring that our products are protected against attacks throughout the supply chain lifecycle, from design, parts procurement and manufacturing to transportation, service and recycling. Acer strives to create the safest designs for users, including but not limited to the following measures:

Hardware Design

- TPM2.0 (Trusted Platform Module, TPM): An international standard for secure cryptographic processors that reduces the risk of hackers trying to capture passwords and encryption keys for sensitive data.
- Kensington locks: It physically protects data by making machines difficult to steal.
- Security screw: Some desktops are equipped with security screws to prevent users from easily opening the case and stealing the internal parts.
- System Health Indicator: Some desktops are equipped with an indicator. When the computer detects an abnormality, the Acer System Health Indicator will immediately notify the user by flashing the red light on the power button to remind the user to perform proper system checks. If the user cannot access the system, they can also enter the system indicator status in the Acer Control Center and BIOS.
- Intel vPro®: Some desktop and notebook CPUs include Intel vPro® technology (including the Acer Chromebox CX15 and Chromebox Enterprise CX15, mini-desktops that will expand the ChromeOS product line in 2023). Hardware Shield information security ensures security, application and data protection, and advanced threat detection under the operating system, creating multiple layers of protection for today's hybrid work environments and providing a level of stability that IT staff can rely on.

Firmware

- Hard drive password and OPAL: Setting a hard drive password prevents unauthorized access to the user's hard drive, and OPAL provides more stringent hard drive protection.

Software

- Acer ProShield Plus: In 2021, some business computing products adopted Acer ProShield Plus, which provides personal secure storage areas in addition to file encryption and destruction capabilities. Users can set up alerts to record invalid logins, and the system will also send email alerts. Once access is disabled, the user will be regarded as an intruder and their image recorded by camera and logged in the security report. Users can set the protection status for each browser (Edge, Chrome, Firefox) and once Windows Hello authentication fails, the user's data (bookmarks, accounts, passwords) will be locked.
- Acer Office Manager (AOM): Through the AOM system, an office without dedicated IT staff can effectively and directly control and maintain the computers of various users across the company, as well as to monitor devices and platforms throughout the enterprise ecosystem.
- Anti-virus software: Equipped with McAfee or Norton anti-virus software to detect potential hazards and remove them.
- USB Device Filter: Some commercial desktops are equipped with a USB device filter. Different corporate ITs can set company-wide USB restrictions for their own company attributes: only data can be read, or only a mouse or a keyboard is allowed, or no restrictions at all.
- Other related software: Acer control center and Acer Care Center continuous protection of customer data enable users to connect to the Acer support infrastructure, accommodating all their support needs including a full range of services, inspections, and updates to ensure equipment is up-to-date and running smoothly.



Customer Service

Acer's success depends on the trust our customers have in us. We strive to provide the highest quality in all of our operations. From product design through production to after-sales service, we continually strive for innovation and improvement, all while also complying with domestic and foreign legal requirements for performance and customer safety.

Acer's vision is to become a "leading brand company in sustainable management through innovation and attentive service and customer care, continuously improving the efficiency and quality of our services." We firmly believe in the pursuit of quality in everything we do, and that this approach will ensure we remain competitive. To ensure our customers are satisfied, we actively strive to understand their needs and to develop better, easier to use products and services that meet, or even surpass, expectations. In this way, we create greater value for our customers.

| Multiple Service Channels

Acer is devoted to helping customers understand the features of our products and services, and to using a variety of methods to understand what our customers need. Our customers should feel free to contact us at any time and provide comments and suggestions through the following channels:

<p>Acer Answers</p>	<p>Social Media</p>	<p>Online Chat</p>
<p>Call Center</p>	<p>D-port Repair</p>	<p>Mail service</p>

We have set up maintenance centers around the world, and cooperate with authorized service centers where required. The network is made up of Acer-operated service centers and authorized maintenance centers. The five main characteristics of this service model are:

- Mixed Mode**
 Combining our own venues with partnered telephone service and maintenance centers
- Acer IT System**
 "One Company, One System" Acer's IT System provides service units with seamless, real-time linkage
- Parts and Logistics**
 Our parts center and regional service centers, managed by a single system, along with parts centers in all corners of the globe, are ready to respond to customers' maintenance service needs
- Multiple Brands**
 Consistently meeting customers' needs across different brands around the world
- E-service Application**
 News, sales & service, Q&A, service locations, case status, warranty information, customer service centers, home delivery



Acer e-Service application Version 3.8, customers can easily access service information through smartphones



Enhancing Service Quality

Improving Customer Service

Acer Taiwan continues to offer "One-Year Extended Warranty Card " in 2023 at distributors such as TsannKuen, Mitsui, CReTE and Acer eStore, allowing customers to purchase products with a one-year extended warranty according to their needs and continue to provide customized installation services for customers who purchase Acer products, so that if customers need to upgrade their services after purchasing Acer products, Acer's maintenance centers or authorized maintenance centers can provide related consultation and installation services.

Acer USA provides a Customer Live Chat in more than 10 Central and South American countries in English, French, Portuguese and Spanish to handle customer calls from Central and South American countries other than the U.S. and Canada, and to handle customer questions online in a more real-time manner to reduce the hassle of sending products to repair centers. "WhatsApp" has been introduced in Central and South American countries, allowing customers to contact Acer's customer service window directly through the app on their cell phones. The customer service lines in Brazil still cooperate with the same partners that Acer has been working with for the past seven years.

Self-Testing System

The Acer Care Center is a software suite for optimizing Acer notebooks and desktops, helping users keep their devices in top condition. ACC can also link users to Acer's support team to get them the assistance they need. ACC provides comprehensive service, including checks and updates, ensuring users can keep their devices up-to-date and running smoothly. The system can offer a dedicated page for each product by model and country through the product support page function, and customers can link to the pages to download product manuals and drivers, reducing the time spent by customers searching for product support services.

• My System

Providing detailed hardware and software information, giving users an easy way to get information on system components including the operating system, CPU, graphics system, memory, and more.

• Detailed Computer Checks

Using PC Checkup, users can get diagnostics and status reports for their hard drives, batteries, and networks. By providing them with the information they need, this helps them get an insight into whether their devices are running properly and how to unleash those devices' full potential.

• Tune-Up

Using a disk cleaner, disk defragmenter, startup manager, and junk removal tools, Acer Care Center helps users keep devices in peak condition. These four services help users improve performance. Acer Care Center also provides Smart Tune-up functionality that enables the system to automatically optimize performance.

• System Updates

Acer Care Center makes it easy for users to get the latest system updates. With the push of a button, they can download and install any available updates. Acer Care Center also offers updates to Acer products drivers, as well as keeping detailed logs of versions and update dates.

• Support Information

Using Acer Care Center, users can find the closest service center, access the Acer community, look through FAQs, and connect Acer support pages. Users can also view their serial numbers and product ID numbers, which can be used to get more information on their devices from the Acer website.

• Recovery Management

Using Acer Care Center, users can backup or restore system settings and networking drivers to protect against the effects of system failures. The recovery management function assists users in reinstalling Windows 10 and can also help restore system settings.



Acer Community: Online Communications, Prompt Responses

Acer Community website provides customers with an online communications channel that enables them to post their problems at any time and receive prompt, accurate responses from other Acer Community members. Acer Community has reached 518,569 members in 2022 and continues to grow, with 19,545 new questions, 110,553 posts and comments, and over 5,000 solutions. There was a total of 9,775,169 visits with 17,327,049 views in 2022. In addition, in 2022, our ACE team added 1 additional superusers, for a total of 41. The website supports multiple languages, including English, Spanish, German, Portuguese and French, providing channels that span borders.

In addition, Acer Support has accumulated 138,000 subscribers on Youtube, and the Acer Support team occasionally releases in-depth videos that explain problems with Acer products, providing users with a quicker, more intuitive way to understand the products they are purchasing.

The Acer Product Evaluation Program (APEP) is a product testing program that allows expert members of the Acer Community to test out the latest products. Their feedback can then help us improve our products and be more innovative. Relevant departments, including the management team, marketing, and UX, evaluate and discuss user feedback and lay out plans for improvements.

Global Customer Relationship Management System

A good system is fundamental to excellent customer service. To improve customer service, we developed the Acer Customer Service System (CSS) to centrally manage Acer's directly-managed service centers, authorized service centers, professional maintenance companies, telephone service support centers, spare parts planning and warehouse management, as well as managing customer interactions through the network. In this way, we can ensure improved service speed and quality.



In addition, we have also improved the functions of the customer relationship management system, providing customers with a mobile application through which they can make inquiries and can track service requirements. Technical service engineers can also work online. In order to improve maintenance quality and reduce maintenance time, all regional service centers also make use of the Acer Diagnostics Suite (ADS). With the introduction of the ADS into maintenance centers, the system returns test results to the CSS to provide the basis for repair work, thereby improving diagnostic accuracy and improving the rate of second repairs.

The new Global Customer Relationship Management System (Version 8) makes use of the latest technology to strengthen and integrate processes across regions. In 2022, Asia Pacific continues to use the new Version 8 system for corporate customers, improving the service and support provided to them and providing service for products beyond just computers.

To improve security, all global CRM application versions have been upgraded to OS / SQL 2012 to support Acer's service business needs in global regions.

| Customer Satisfaction Survey

Acer In-House Training System: Improving Customer Service Problem Solving Capabilities

To provide consultation and assistance to customer service staff worldwide, Acer uses an online learning system (Acer E-Academy) to train frontline customer service staff and operations staff on new product expertise, FAQs, customer response skills and standard procedures, and includes online post-course evaluations. In order to improve the user interface and upgrade the coverage, Acer Europe introduced the eLearning portal to provide professional training to internal staff on maintenance techniques and troubleshooting. So far, different training courses have been added, and more are coming. Through this system, we are able to provide staff with the latest product knowledge, helping them more effectively deal with customer inquiries through a set of standard methods and through a virtual journey, even without seeing the actual product.

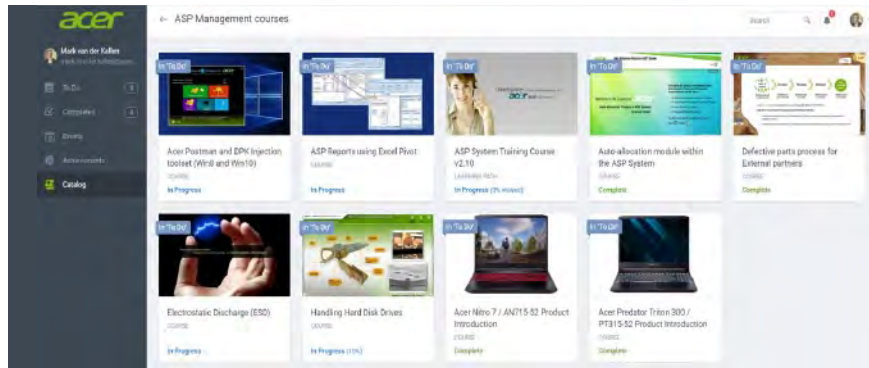

We carry out Acer Customer Satisfaction Surveys in each country individually. As such, methods can vary. However, headquarters still regularly collects the results of our surveys and reviews them for trends and insights. Current survey methods include telephone, online, face-to-face interviews, and telephone interviews with corporate customers. In addition, we also began to ask customers about their purchasing experience on the Acer Store website and adding survey channels to enhance our services.

We have set the following goals for customer service improvement in 2023:

- Continued implementation of a fan management system integrating sales and computer health clinics. Implement a bidding system for companies and schools, carrying out computer health clinics and establishing strong customer relationships.
- Research and planning of a set of PWA-run application software to provide real-time product-related information for customers' purchased products, so that customers can be the first to grasp BIOS, driver, and product-related updates, as well as to provide the nearest service center information for customers' location, so that customers can contact Acer's customer service center more quickly when they need product service.
- Improve service center information systems so that the customer service staff can better understand customers' records and reduce the time needed for service, boosting customer satisfaction. Europe has begun using the Unified Agent Desktop tool, making it easier for staff in the service center to get information on client machines and provide thorough service.
- Continue to observe and reduce customers' second repair rates to boost consumer satisfaction and loyalty.



To improve customer satisfaction, we conduct regular (weekly or monthly) reviews of authorized service centers; if a problem is found or an incident occurs, the center will also provide a corresponding corrective plan. Currently, the majority of both internal maintenance centers and partner authorized service centers, have successfully obtained relevant ISO certifications, such as ISO 9001 and ISO 14001.

In aggregate, our 2022 survey results show high global satisfaction, with positive customer evaluations accounting for 94.6% of total evaluations.

The average customer satisfaction survey results were slightly higher than last year, mainly because the epidemic was still severe at the beginning of the year and many maintenance departments were struggling to maintain service quality despite the shortage of manpower. Until July when the epidemic eased, the service efficiency gradually improved, but overall it was within the normal range of fluctuation.

Global Customer Satisfaction

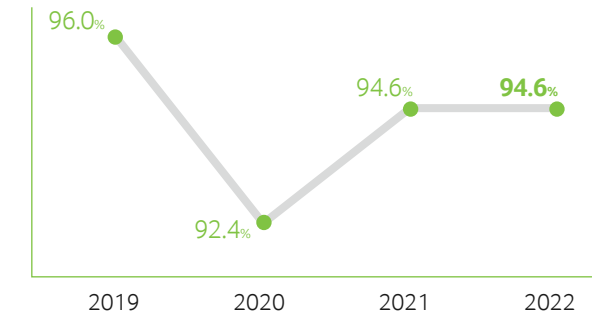

Specific Management Methods for Customer Privacy Protection

To ensure the customers' privacy rights are protected, Acer will inform the customer of the following precautions and confirm their acceptance of the following before the customer agrees to send the product for repair (details may vary from country to country depending on local regulations)

- The call center informs customers that all calls will be recorded and logged in the maintenance record after repair delivery is confirmed
- Remind customers to back up all data on their computers
- Explain the risk of loss and damage to personal data and computer settings during the repair process
- Require the customer to sign an authorization form that sets out customer privacy and maintenance terms and conditions



World-Recognized Customer Service

Acer Spain



For the fourth year in a row, Acer Spain has been voted as Customer Service of the Year in the Consumer Computing category.

Acer Switzerland



Acer Switzerland received the Top 3 Most Valuable Service Award for the third consecutive year (2020-2022)

Acer Italy



Acer Italy won the Service Excellence Award in “MiglioriIn Italia” - for laptops and desktops in 2022.

Acer China



Acer China has been awarded the Service Brand of the Year 2022 by Computer News. Since 2006, Acer China has received this honor for the 16th time.

Operations and Environment

| Environmental Policy and Management

Acer actively pursues balanced economic, environmental and social development. We are committed to environmental protection because we understand that all of our products, services and activities may impact the communities and environment in which we operate. To fulfill our corporate social responsibility, we request our employees to understand their roles and responsibilities, and we also request our suppliers, service providers, contractors, outsourcers, logistics providers, merged and acquired companies and value chain partners to reduce their environmental impact through their lifecycle, and to comply with Acer's environmental, health and safety policies to fulfill our commitment to environmental protection.

To achieve the sustainable goal of environmental protection, we require the following two types of offices: (1) with more than 100 employees and (2) less than 100 employees but with high-risk operations, to implement EMS environmental management system and set up a working group to promote operational performance according to the PDCA management model, and ensure the system can maintain effective operation through third-party certification or internal verification mechanism every year. At the same time, the number of office locations under 100 people are encouraged to participate in the certification on their own.

Coverage of Global Environmental Management System (EMS)

EMS coverage rate

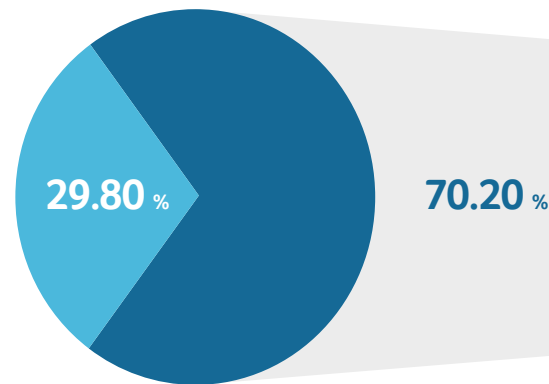

Promotion of EMS

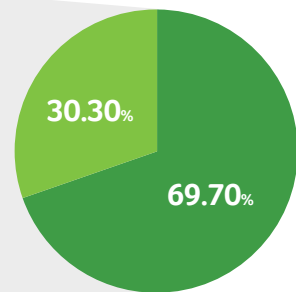

Note 1:
In 2022, the EMS implementation goal includes two categories of office locations: those with a global workforce of 100 or more people and those with fewer than 100 people but engaged in high-risk operations.

Note 2:
When considering the total global workforce, the EMS coverage rate in 2022 is 70.20%. However, when considering only office locations with 100 or more employees globally, the EMS coverage rate is 100%.

Note 3:
The focus of EMS implementation in 2025 will be on including office locations with 50-99 employees, with an estimated global coverage rate of 85.03%.

Not implement
 implement

Internal verification
 Third party certification

Energy Usage Management

The major energy consumption for Acer is office electricity, of which air conditioning, lighting, and data center use are the primary ones. For effective management, we use systematic data collection to understand the usage situation and grasp the trend of change, and encourage each office area to carry out energy-saving measures such as optimizing power consumption equipment and strengthening power consumption management, as well as using renewable electricity and producing renewable electricity in the hope of reducing office power consumption every year.

The Xizhi Headquarter conducts ISO 50001 energy management system certification every year and uses the system to promote the setting of reduction targets. In 2022, after a comprehensive review and evaluation of the plan, we set a long-term goal of reducing total electricity consumption by 10% in 2030 compared to 2021. To further promote the use of energy efficiency in each office area, we are conducting energy-saving measures to evaluate two high electricity consumption office areas, including Acer's Enabling Data Center (eDC) Longtan Office and Aspire Resort, and continue to explore the feasibility of various ways to reduce electricity consumption.

In the fourth quarter of 2022, Acer's Xizhi Headquarters and Acer eDC Longtan Offices have been replaced with active magnetic bearing compressor chiller, which is expected to be completed in 2023. Meanwhile, the Xizhi Headquarters and Aspire Resort have completed the installation of electric vehicle charging station. To further understand the operation efficiency of the air conditioning system, the Xizhi Headquarters has completed the construction of the monitoring system and has fully implemented systemized management.

To reduce the impact of CO₂ emission from electricity consumption on the environment, in 2022 we will launch the Green Earth Campaign. The largest green power park in Northern Taiwan, the Aspire Resort, were planted with trees. We are planting Acacia trees, a native species of Taiwan with high carbon absorption capacity, on the land formerly used as a weed forest for national conservation. Through the reuse of the idle site, a green cycle is created, and through this "demonstration site for afforestation and reforestation", the industry is called upon to participate and promote the trend of tree planting and carbon reduction. The event was held in collaboration with the Eco-Hotel - Aspire Hotel, which has a Gold-level Green Mark, and spent three weeks on land preparation, planting and reforestation to reuse the idle land, planting a total of about 0.5 hectares of Acacia trees. We are actively taking action to help the Earth, and based on the research report from the Forestry Research Institute of the Council of Agriculture, Executive Yuan, we estimate that 0.5 hectares of 20-year-old Acacia trees can potentially reduce carbon emissions by 190 metric tonnes in the future.



Acer Taiwan's 2021 Main Energy Saving Measures

Type	Energy Saving Measures	Office Area Implemented	New Measure(s)	Ongoing	Efficiency (Year)
Production of Renewable Electricity	Solar Power Generation	Acer Taiwan Longxian Solar Power Station		○	Generation of approximately 3.152 million kWh of power
		Acer Taiwan Aspire Park Aspire Resort		○	Generation of approximately 21,000 kWh of power
		Acer Taiwan Aspire Park Aspire Research Complex		○	Generation of approximately 104,000 kWh of power
		Acer eDC Longtan Offices		○	Generation of approximately 51,000 kWh of power
Air Conditioning System	Updated Air Conditioning Equipment	Acer Taiwan Xizhi HQ	○		Estimated completion in 2023
		Acer eDC Longtan Offices	○		Estimated completion in 2023
	Turn Off Air Conditioning Equipment	WebLink Taipei Headquarters	○		Saving of approximately 7,000 kWh of power
	Reduced Leakage of Cold Air from Data Center Air Conditioning	Acer eDC Longtan Offices		○	Saving of approximately 126,000 kWh of power
	Improved Cooling Tower Air Flow	Acer eDC Longtan Offices		○	Saving of approximately 180,000 kWh of power
Lighting Fixtures	Changed to energy-saving lamps	Acer Taiwan Xizhi HQ	○		Saving of approximately 135,000 kWh of power
		WebLink Taipei Headquarters	○		Saving of approximately 1,800 kWh of power
	Changed to energy-saving lamps during new office renovation	Acer Synergy Tech Zhubei Offices	○		
Heating Equipment	Cancellation of the Provision of Electric Heaters and Replaced with Electric Blankets	Aspire Dormitories	○		
Employed electricity monitoring	Using Energy Management Systems	Acer Taiwan Xizhi HQ		○	
		Acer Taiwan Aspire Park Aspire Resort		○	
		Acer Taiwan Aspire Park Dormitories		○	
		Acer Taiwan Aspire Park Aspire Research Complex		○	
		Acer Taiwan Aspire Park Zhizun Building		○	
		Acer eDC Longtan Offices		○	
Using UPSs	Installation of Air Conditioning Monitoring System to Control Operation Performance	Acer Taiwan Xizhi HQ	○		
		Shutdown settings	Acer eDC Longtan Offices		○
Lighting	Using automated shut-off system	Acer Taiwan Xizhi HQ		○	

Note: Disclosure of electricity consumption optimization and the benefits of stronger electricity consumption management employs estimations to calculate savings before and after improvements.

Waste Management

Acer does not have any manufacturing plants and the main source of waste is general household waste. To reduce waste production, we follow the practices of Reduce, Reuse, Recycle. And invite colleagues to participate in the global Earth Mission-21 Days Green Challenge to develop good habits of caring for the environment and to shape the concept of green environmental protection.

In daily life, we encourage our employees to reduce the use of disposable plastic, tableware, and paper cups, and to strengthen waste reuse through the implementation of various resource recycling and regular business waste recycling management methods.

For the disposal of waste, we uphold the laws and regulations and comply with the company's environmental management policy. General household wastes is delivered to the local incineration plant by the building in cooperation with manufacturers or local cleaning teams; resource recovery items are sorted and delivered to recycling manufacturers or local resource recovery vehicles; business waste such as waste batteries, waste lamps, waste machine cases, hardware waste, etc. are collected and delivered to qualified contracted manufacturers for disposal to ensure that the process of transportation and disposal does not damage the environment and ecology.

To reduce waste output, the Xizhi Headquarters is working with the building management to evaluate the introduction of paper container recycling operations, which is expected to be implemented in the second quarter of 2023. To reduce the impact of waste incineration on the environment, the destruction of confidential documents has been changed to water destruction from 2021.

According to Acer's global waste statistics for the past five years, the total recycling and reuse volume has been increasing and the total waste disposal volume has been decreasing.

Acer Global Wastes Statistics

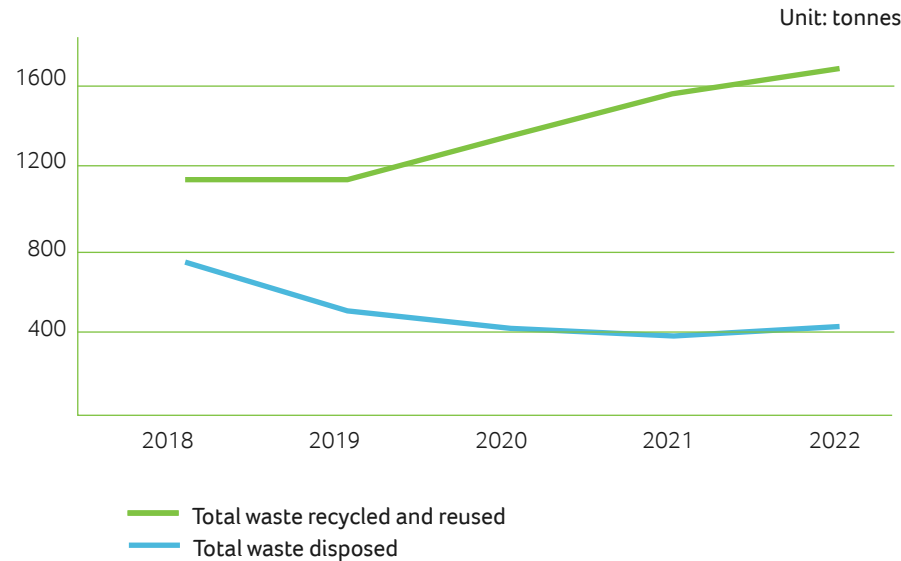

Note 1: Total waste recycled and reused refer to the recycling and e-wastes generated from employee operational activities, excluding client-side recycling statistics.

Paper Usage Management

To mitigate the impact of deforestation and consequent biodiversity loss on the ecosystem, as well as to demonstrate our commitment to valuing paper resources, Acer Taiwan has implemented a variety of measures to our internal paper usage.

· Paper procurement

We choose to purchase copier paper with the PEFC (Program for the Endorsement of Forest Certification) mark and toilet paper/paper towels with the Green Mark.

· Paper selection

For computer report paper, report paper, envelopes and other paper products, we select suppliers who use environmentally friendly pulp at the source of manufacturing.

· Internal promotion

Electronic document instead of paper printing, use of duplex and multi-page printing function, paper recycling, bring your own water cup to meetings and reduce the use of paper cups.



Change in photocopying paper consumption in Acer Taiwan from 2020 to 2022 compared to the previous year

Photocopying Paper Consumption Range

2020	2021	2022
-21.48 %	-10.03 %	+0.30 %



| Water Resource Management

Water Resource Management

Indicators related to GRI/SASB

GRI 303

Policies/ Commitments

Although the main water consumption is for basic livelihood use in office premises, and there is no significant use of water resources, we still set annual reduction targets and continue to explore various reduction possibilities.

Stakeholder Engagement and Effectiveness

The 2022 Materiality Survey shows that Water Resource Management is a major stakeholder topics of concern. To address this topic, in addition to ongoing water management, setting goals, actions and monitoring, we have launched a Save the Planet mission in 2022: the 21-Day Challenge to engage our employees and business partners in water reduction actions.

Action Plan

- Collection and Reuse of Water Resources
- Improving Water Using Facilities
- Strengthened Water Usage Management

Tracking Mechanism

- ISO 14001 environmental management system has been introduced to maintain the effectiveness of the system through full employee participation and internal and external audits.
- Through systematic management, we collect global water consumption data and trends, and review the status of target achievement annually.

Medium- and Long-Term Goals

10%

Total water consumption in 2025 needs to be reduced by 10% compared to 2018^{Note}

2022 Goals

1%

Total water consumption reduced by 1% compared to 2022

2022 Achievement Status

1%

Accomplished. Total water consumption is reduced by 1% in 2021

2023 Goals

1%

Total water consumption reduced by 1% compared to 2022

Note: The medium to long-term goals have been achieved (a reduction of 18% compared to 2018), and in 2023, we will assess the global water usage situation to discuss the water reduction target for 2030.

Acer's global business model is aimed at product sales and customer service without production and manufacturing. Thus, it does not consume a lot of water resources. As water resources became an important issue, Acer sets an annual goal of reducing the total water withdrawal by 1% compared to the previous year and a medium and long-term goal of reducing the total water withdrawal by 10% in 2025 compared to 2018 despite the general nature of office operations has limited effect on water consumption reduction. To achieve the goal, Acer collects global water consumption data and trends through systematic management with annual progress reviews. At the same time, we encourage all offices to implement water-saving measures such as water resource recycling and reuse, upgrading water equipment, and improving water management.

The Aspire Resort in Longtan has long been committed to water saving measures. To reduce the use of massive water resources in the swimming pool and paddling pool, we implement wastewater collection and treatment, and reuse it through filtration facilities and ozone disinfection process. At present, the water consumption is mainly the replenished dissipated water after the natural overflow, and the statistics of 2022 overflow replenished dissipated water was about 4,934 kWh, which was about 19% of the total water consumption of the resort. In 2022, the Aspire Resort was again awarded the "Gold Label of Excellence in Water Quality Certification" by the Taoyuan City Government Health Bureau, recognizing our dedication to maintaining the quality of water for consumers.

Acer Taiwan's 2022 Main Water Saving Measures

	Water Saving Measures	Office Area Implemented	Efficiency (Year)
Collection and Reuse of Water Resources	Using reclaimed water for irrigation of greenery	Acer Taiwan Aspire Park	Recovery of approximately 43 million liters of water
	Swimming pools and paddling pools implement wastewater diversion collection and treatment, and reuse through filtration facilities and ozone sterilization process	Acer Taiwan Aspire Park Aspire Resort	Replenishing of approximately 4.934 million liters of dissipated water
	Recycling and reusing air conditioner condensate and dehumidifier drainage water	Acer Taiwan Aspire Park Aspire Resort	Recovery of approximately 0.617 million liters of water
Improving Water Using Facilities	Rainwater reuse and recycling	Acer eDC Longtan Offices	Recovery of approximately 4.987 million liters of water
	Recycling and reusing dehumidifier drainage water	Weblink HY Life Zhonghe, Taoyuan Store	
	Using water pre-tank filtration system to reduce water consumption from frequent cleaning	Acer Taiwan Aspire Park Aspire Resort	
Strengthened Water Usage Management	Replacement of sensor faucets with water-saving labels in public areas	Acer Taiwan Aspire Park Aspire Resort	
	Regularly inspecting water-using facilities	Acer Taiwan Offices	
	Promotion of water conservation	Acer Taiwan Offices	

Water Resource Management Process



Water Consumption

The water used in Acer's office premises is essential for people's livelihood (e.g., drinking, washing, cleaning, air conditioning) and is the main water demand. The source of water is taken from the municipal water supply, and a small portion is well water, which has no significant impact on water sources.

In 2022, Acer used 162.655 million liters of water worldwide, with well water accounting for about 4.646 million liters of that. Total water consumption decreased by 1%. Water consumption has been decreasing every year for the last 5 years.

Global Water Consumption

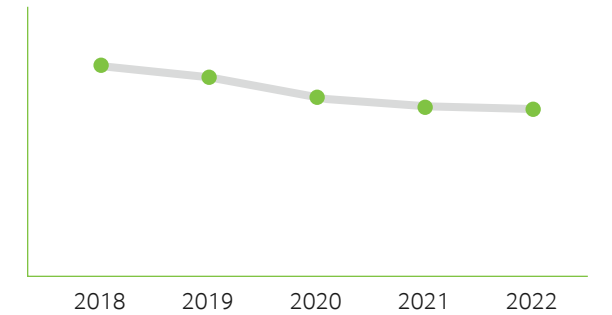

Wastewater and Reclaimed Water

Acer's main wastewater production is from basic domestic wastewater (e.g., washing and cleaning), which is discharged to public sewers and then treated at local wastewater treatment plants in accordance with local regulations. Since we do not use chemicals or organic solvents in our operations, we have no significant impact on the ecological environment. Sewage accounts for an estimated 80% of water usage, with the remaining 20% used for air conditioning. The scope of this data is consistent with previous years' water usage data scope. In 2022, Acer used 130.124 million liters of water worldwide.

The Acer Aspire Park in Longtan, Taiwan is our main site of water recycling. The wastewater in the park is treated in a wastewater treatment plant and turned into medium water for green watering in the park. In 2022, Acer collected 37.978 million liters of water worldwide, accounting for 23.3% of total water consumption, an increase of 6.8 million liters of water compared to 2021.



| Biodiversity

Biodiversity

Indicators related to GRI/SAS

GRI 304-1~4

Policies/Commitments

Acer is committed to better understanding the potential impacts of our operations on biodiversity, as detailed in the "[Biodiversity Commitment](#)" page.

Management Process

The ESG office studies biodiversity topic, convenes the relevant units to communicate and implement relevant projects, and the Corporate Sustainability Committee validates the results.

Action Plan

As biodiversity is an emerging issue, the main action plans for 2022 were:

- Understanding international trends and requirements for biodiversity
- Understanding biodiversity-related assessment tools

Tracking Mechanism

- Track effectiveness through semi-annual meetings of the Corporate Sustainability Committee

Stakeholder Engagement and Effectiveness

Join the Taiwan Nature Positive Initiative launched by the Business Council for Sustainable Development to learn more about biodiversity risk-related issues

2022 Goals



Choose appropriate tools to assess biodiversity risk across all of our operating sites.



Communicate the importance of biodiversity to suppliers and encourage them to conduct biodiversity risk assessments for their sites of operation.



Include biodiversity as one of the themes in Acer Global ESG Project Awards

2022 Achievement Status



Select the Protected Areas website tool to conduct a preliminary assessment of Acer's operational sites and confirm that no sites are located in areas with the potential to affect biodiversity.



Communicate the importance of biodiversity to suppliers and encourage suppliers to conduct biodiversity risk assessments for their operating sites at the supplier ESG communication meeting on December 22, 2022



Include biodiversity as one of the Acer's 2022 ESG project award themes



Join the Taiwan Nature Positive Initiative, a platform for nature and biodiversity advocacy

2023 Goals



Further assess the biodiversity-related risks at our operational sites using other tools. Require our suppliers and partners to assess the biodiversity-related risks of their operating sites and encourage them to develop biodiversity commitments

Biodiversity is the foundation of all life, and maintaining the quality, quantity, and resilience of ecosystems is critical to the health and stability of natural capital. In 2022, the Conference of the Parties to the United Nations Convention on Biological Diversity (COP15) adopted the Post-2020 Biodiversity Framework, making biodiversity one of the most important environmental issues after climate change. Acer is actively aware of this international trend and has developed a "[Biodiversity Commitment](#)" that outlines its goals for 2022 and has been approved by the Corporate Sustainability Committee, chaired by the Chairman of the Board of Directors, to initiate actions accordingly. The commitment is then further reviewed, approved, and supervised by Acer's Board of Directors.

In our own operation

To effectively address biodiversity issues, we need to conduct risk assessments to understand the current situation, identify priority areas, set targets, and apply mitigation measures. In view of the international biodiversity risk assessment and target setting tools such as Taskforce on Nature-related Financial Disclosure (TNFD) and Science-based Target for Nature (SBTN) and others are under development, so we first used the tool [Discover Protected Areas and OECMs](#) provided by [Protected Planet](#) to confirm that none of our global operations are located in important biodiversity sites.

We have also included biodiversity as one of the themes in our global ESG Project Awards to raise awareness of biodiversity among Acer employees worldwide.

A total of eight biodiversity-related projects are proposed for 2022 across Acer's global operations, including beach cleanup activities in Singapore and Germany, desert sand cleanup activities in the Middle East, harvesting of native plant seeds in the U.S., whale research sponsorship in Spain, tree planting projects in the Middle East, and marine plant restoration project in Italy.

In terms of supplier management

We educated suppliers on the importance of biodiversity and non-deforestation at the 2022 Supplier ESG Communication Meeting, requested suppliers to plan early biodiversity risk assessments for their operational sites, and encouraged suppliers to develop forest conservation commitments or policies to jointly reduce the demand for deforestation in the supply chain.

In terms of partnerships

Acer participates in the Taiwan Nature Positive Initiative launched by the Business Council for Sustainable Development to gain a deeper understanding of international biodiversity trends and the expectations of stakeholders.

In 2023, we participated in the "GRI 304: Biodiversity Revision Consultation Workshop" through this initiative to provide feedback from Acer's perspective in addition to getting an early grasp of the key points of the GRI revision.



Acer Italy has sponsored Marevivo Onlus' [REPLANT](#) project starting in 2021, aimed at reforesting the sea in areas threatened by human activities that have caused the disappearance of nearly 80% of algal forests. For every purchase of Aspire Vero computers, Acer donates funds to support this project. In 2022, a total of 15,000 euros were donated.





04

RESPONSIBLE SUPPLY CHAINS

Our suppliers are the most important partners. Beyond the economic value that our supply chain brings, we are also focused on social and environmental impact, building on a foundation of respect for human rights and working diligently toward a sustainable supply chain. Through the Acer Responsible Supply Chain Management (ARSM) mechanism, we jointly shoulder our responsibilities toward society and the environment alongside our supply chain, expanding out from our first- and second-tier suppliers to the third tier and gradually working toward the realization of sustainability goals.

• Supply Chain Management Mechanisms	73
• Supply Chain Social Management	76
• Supply Chain Environmental Management: Supply Chain Climate Engagement	79
• Supply Chain Audit and Improvement	81

260,000 people

Number of direct supplier employees audited in 2022

100%

Proportion of smelters in the supply chain that meet the target of qualifying or participating in the OECD third party mechanism

A-

The CDP Supply Chain Engagement Rating (SER) is maintained at the A- rating

Supply Chain to Environmental and Social Management & Performance

Indicators related to GRI/SASB

GRI: 2-6, 308, 408, 409, 414-1~2, 308-1, 308-2, 407-1

SASB: TC-HW-430a.1~2

Policies/ Commitments

We also focus on social and environmental impact, building on a foundation of respect for human rights and working diligently toward a sustainable supply chain.

Stakeholder Engagement and Effectiveness

- RBA Code of Conduct and VAP audits
- Supplier Response Rate: ESG Scorecard, Conflict Minerals Report
- Customer Questionnaire Response Rate

Action Plan

- Through the Acer Responsible Supply Chain Management (ARSM) mechanism, we jointly shoulder our responsibilities toward society and the environment alongside our supply chain to achieve sustainable goals.

Tracking Mechanism

- Supply Chain Task Force (Corporate Sustainability Committee)

Medium- and Long-Term Goals

Environmental

80% 80% of critical suppliers commit to RE100 or set Science Based Targets (SBT)



CDP supply chain project participates in expansion and third-tier suppliers

Social

100% 100% of smelters are conformant to/ participate in OECD-aligned third-party mechanism

ISO

All suppliers are required to obtain ISO 9001, ISO 14001 and ISO 45001 and all three certificates, and perform regular RBA VAP audits (or obtain SA 8000 certification)



Continuously provide suppliers with RBA Code of Conduct on-site conformance audit percentages



RBA audits extend to third-tier providers

2022 Goals

Environmental

60% 60% of critical suppliers commit to RE100 or set Science Based Targets (SBT)



Invite third-tier suppliers to participate in the CDP Supply Chain Climate Questionnaire

Social

100% 100% of smelters are conformant to/ participate in OECD-aligned third-party mechanism

70

RBA VAP audit:

400 70 first-tier suppliers
400 second-tier supplier audits

2022 Achievement Status

Environmental

60% 60% of critical suppliers commit to RE100 or set Science Based Targets (SBT)



Completed invitation to third-tier suppliers to participate in the CDP Supply Chain Climate Questionnaire

Social

100% 100% of smelters are conformant to/ participate in OECD-aligned third-party mechanism

105

RBA VAP audit:

893 105 first-tier suppliers
893 second-tier supplier audits

2023 Goals

Environmental

65% 65% of critical suppliers commit to RE100 or set Science Based Targets (SBT)



Continuously invitation to third-tier suppliers to participate in the CDP Supply Chain Climate Questionnaire

Social

100% 100% of smelters are conformant to/ participate in OECD-aligned third-party mechanism

70

RBA VAP audit:

400 70 first-tier suppliers
893 second-tier supplier audits

| Acer's Supply Chain

Acer is working together with our suppliers to provide customers with valuable products and services. Our first-tier suppliers include: ODM/OEMs, key components, assigned suppliers, logistics, and services.



We define key suppliers based on procurement amount, substitutability, strategic importance, and technological leadership. We support a balance between local procurement and supply chain diversification, reducing overall supply chain carbon emissions and creating local employment opportunities, while also reducing overall supply chain risk.

Percentage of Critical and Non-Critical Suppliers



Supply Chain Management Mechanisms

Acer Responsible Supply-Chain Management (ARSM)

Acer has been a member of the Responsible Business Alliance (RBA) since 2008, and actively participates in actions and discussions around supply chain social and environmental responsibility to better understand international trends in corporate responsibility and share in the practical experience of its members.

With the implementation of the Acer Responsible Supply Chain Management (ARSM), all Acer manufacturers and service providers are required to comply with both the RBA Code and local regulations, with no regional differences. We also carry out annual on-site RBA Code of Conduct supplier audits, gaining a deeper understanding of each location's working environment and the human rights conditions of the staff.

To ensure effective implementation, the supply chain ESG management and plans are jointly developed and executed by the procurement department and the ESG office, and they are supervised by the Corporate Sustainability Committee and the Board of Directors.

We encourage and require suppliers to take corporate responsibility and manage the social and environmental responsibilities within their supply chains. We advocate for RBA Code of Conduct adherence, thus improving the working environment in the electronics supply chain worldwide.

With the ARSM system, we not only set out the social and environmental responsibilities of our first-tier suppliers, but also roll this out to second- and third-tier suppliers in phases. The goal of this is to further expand the reach of our social responsibility and influence.

Acer requires first-tier suppliers to implement risk assessment and management of second-tier suppliers based on the RBA Code of Conduct. For higher risk suppliers, we also carry out on-site audits and tracking of improvements. We have also integrated performance in these into our Supplier ESG scorecard assessments, realizing and expanding the environmental and social responsibility of our supply chain. We have selected some ODMs for expansion of the scope of responsible supply chain management to third-tier suppliers, and we formally rolled this into routine management activities from 2021.

Acer Responsible Supply Chain Management

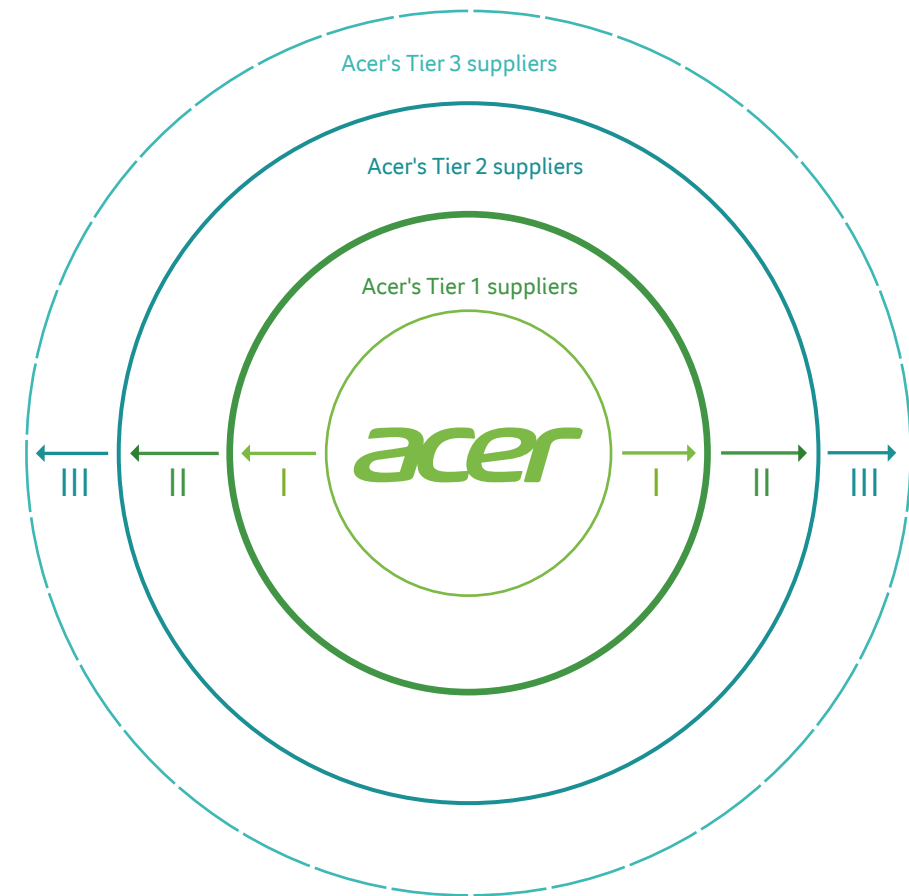

I: 2008~ II: 2016~ III: 2021~

Supplier Social and Environmental Management Processes

We have adopted the [RBA Code of Conduct](#) and, with reference to the RBA Supplier Engagement Process, make use of a range of supplier social and environmental management approaches, engaging with suppliers through multiple channels and working with them to improve their capabilities. The implementation of such management approaches also entails assessment, validation, and ongoing improvement thereof. Through management measures at every stage, Acer and our suppliers are able to work together effectively to establish a sustainable supply chain with a focus on environmental and social issues. New suppliers pass a social and environmental responsibility risk assessment and sign an RBA Code of Conduct compliance statement before they become official suppliers.

Supply Chain Social and Environmental Management Process

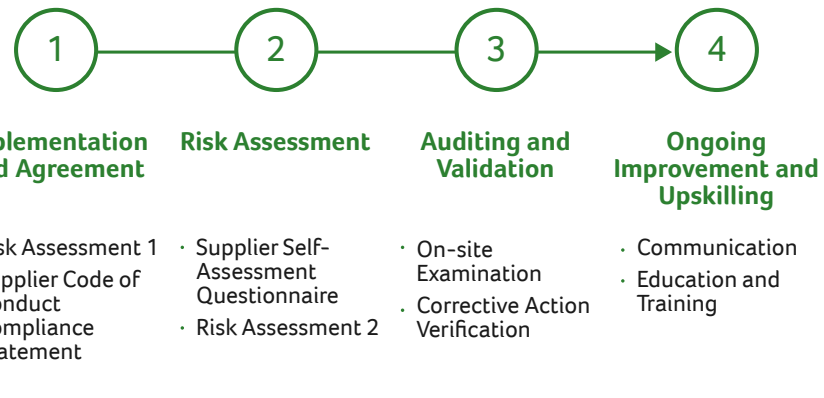

Improving Supplier Capabilities

Vocational Education and Training

For the first time in 2022, we encouraged on-the-job training for suppliers and their employees and selected 12 ODMs as pilot sites for the ESG training program. The initial scope is set to implement the RBA Code of Conduct (including: labor rights, environment, safety and health, ethics, etc.) and anti-bribery policy. The training is conducted for the related indirect and direct employees in the plant. After the Supplier's initial training plan is developed and sent to Acer for content review, the supplier's training team conducts on-the-job employee training. In 2022, a total of 126,681 people has participated in the training, with a total of 105,698 hours. Looking ahead, we will continue to promote on-the-job education and training to enhance the establishment of ESG-related knowledge among suppliers, and expand the number of suppliers and practitioners impacted.



RBA Code of Conduct

IDL Indirect Labor

Total Attendance of Indirect Labor	20,572
Accumulated Total Training Hours	23,382

DL Direct Labor

Total Attendance of Direct Labor	47,656
Accumulated Total Training Hours	39,697



Anti-Bribery Policy

IDL Indirect Labor

Total Attendance of Indirect Labor	19,134
Accumulated Total Training Hours	16,220

DL Direct Labor

Total Attendance of Direct Labor	39,319
Accumulated Total Training Hours	26,399

Supplier ESG Communication Meetings

We continue to communicate with our suppliers and enhance their ability to address sustainability issues, and encourage them to incorporate sustainability into their corporate management agenda. In accordance with Acer's sustainability strategy, we hold various supplier sustainability seminars and annual Supplier ESG communication meetings to provide the latest ESG development trends, analyze the main focus of the Supplier chain on various issues and the actions to be actively taken, as well as provide opportunities for two-way communication between suppliers and Acer executives to strengthen mutual cooperation and provide the supplier chain with the ability to enhance environmental and social responsibility. We held annual Supplier ESG Communication Meeting in December 2022. Over 150 suppliers participated.



Key Points from 2022 Supplier ESG Communication Meeting

Environmental Responsibility

- Inviting suppliers into the Earthion Initiative
- Communication on Acer's 2025 goals, requiring suppliers to set specific carbon reduction targets
- Invite third-tier suppliers to respond to the CDP Climate Questionnaire
- Communication on chemical substance management standard revision
- Advocating the importance of biodiversity and reducing deforestation to suppliers



Social Responsibility

- Promoting the electronic management system of supply chain to enhance the transparency of data flow. In addition, we will continue to actively cooperate with RBA, TCO, EPEAT and other organizations to promote the prohibition and restriction of energy management systems and process chemicals. We will discuss the preparation for ESG-related hot topics.
- Minerals currently prioritized for Acer's responsible minerals program include tantalum, tin, tungsten, gold, cobalt, and mica. Suppliers are required to conduct due diligence in accordance with OECD guidelines and support the processes and tools developed by the Responsible Minerals Initiative (RMI) as implemented by Acer.



RBA Code of Conduct Training

We continue to follow up on changes and updates to the RBA Code of Conduct and provide consulting services to suppliers on interpretation and implementation of improvement plans.

In addition, when there is a significant change in the Code of Conduct, we provide education and training to our internal staff and suppliers in order to quickly and effectively introduce and build the organizational standards and capabilities required by the new issues. Following the training sessions for suppliers on the RBA Code of Conduct 6th edition in previous years, we are planning to recruit relevant personnel to participate in the training activities after the release of the RBA Code of Conduct 8th edition.

E-Network Training Course

We have started to investigate and evaluate the relevant suppliers of e-learning courses, and to negotiate a more suitable and enriched platform to enhance and effectively disseminate the relevant subject matter expertise to the suppliers. For example, RBA has created and planned the Academy online education and training system.

CDP Seminar

Acer has been sponsoring the CDP Taiwan conference for a long time. In addition to providing Acer's supply chain with more international information and management trends related to climate, we also expect more companies to join the climate management initiative.

In 2022, we continuously invited suppliers to attend the CDP conference and seminar. In addition to the analysis of the strengths and weaknesses of the previous year's questionnaire results and the provision of good response cases, the CDP presentation helped suppliers to better understand the content of their responses to the CDP questionnaire, including issues related to the transformation plan and the use of the CDP website and online response system (ORS), so that suppliers can understand the significance of climate information disclosure and improve the quality of information disclosure during the questionnaire response process.



Social Management

| Labor Rights

At the core of Acer’s responsible supply chain management is the idea of putting people first. As such, we strive to protect the rights and health of labor and provide safe workplaces. We have established a complete system of supply chain labor rights management, including conducting risk assessments, on-site audit, and education and training for suppliers, as well as conducting supply-chain-focused human rights training for Acer employees in positions relating to supplier management. To ensure that the human rights of those throughout our entire supply chain are protected and that they are treated appropriately, we also adhere to the [California Transparency in Supply Chain Act of 2010, and Modern Slavery Act 2015](#).

Child Labor and Forced Labor

With regard to high-risk violations of human rights such as child and forced labor, we have drafted our [Slavery and Human Trafficking Policy](#) and [Measures for Remediating Child Labor and Forced Labor](#). These provide complete definitions and remedial measures. As soon as any violations occur, our supply chain is required to follow these measures and policies to ensure that workers are afforded their basic human rights and appropriate treatment. Our ultimate goal is to ensure that our supply chain is free from slavery or human trafficking. For the status of supply chain forced labor inspections, please see the main issues and tracking improvements in this section.

Supply Chain Labor Rights Management Processes



Acer’s risk assessment of its suppliers include the following items: results of supplier self-assessment, level of risk regarding plant location, supplier business relationship with Acer, and past audit results. We also strive to take into consideration the concerns of stakeholders.

After the risk assessment – based on the above criteria – has been conducted, Acer then draws up a list of suppliers that require an on-site social and environmental responsibilities audit to be undertaken by an accredited 3rd party verification agency. We also take part in RBA’s Validated Audit Process (VAP). Adopting a variety of audit models allows us to see the strengths and weaknesses of each model and more accurately uncover discrepancies in our suppliers’ implementation of their social and environmental responsibilities. We continue to improve the social and environmental responsibility in Acer supply chain.

Acer requires all manufacturing suppliers to sign our Declaration of Compliance with RBA Code of Conduct. Suppliers must not only provide us with relevant information on social and environmental responsibilities, but also verify that their own and their suppliers’ operations conform to Acer’s human rights standards, meaning that their workers are treated with respect and dignity.

Acer requires all employees to comply with the Acer Group Standards of Business Conduct (SBC). The SBC includes provisions relating to supply chain issues, including the use of child and forced labor. Any offense or violation against the articles in the SBC will result in corrective action proceedings according to the gravity of the offense committed. Serious offenders will face disciplinary action or be asked to leave the company accordingly. This set of standards is the highest-level behavioral criteria for all Acer employees engaged in corporate activities and is incorporated in our employee performance assessment. Furthermore, all new employees are enrolled in orientation training and asked to honor these behavioral requirements when they first join the company. Procurement staff has to take environmental requirements training when they first join the company.

In order to uphold our responsibility to educate our suppliers and help them understand international trends, Acer holds annual supplier ESG communication meetings and related training sessions. This not only communicates internal trends to the supplier, but also helps them uphold their own social and environmental responsibilities. Through our communication and cooperation with improvement in all aspects of labor rights.

Student Workers and Interns

Student workers and interns comprise a high-risk group in terms of human rights in the electronics supply chain. Acer prohibits any form of forced labor in our supply chain, including forced labor involving students or interns. Taking our cue from the RBA's [Guidelines for Good Management of Interns \(Student Workers\) management framework](#), we have established our own five-stage "Management Steps for Student Workers and Interns" to be followed with students and interns in our supply chain. Student workers may not exceed 20% of total direct employees.

Supplier Working Hours Policy

Excessive working hours are one of the most common labor problems in the supply chain. Working too long can have a negative impact on the health and safety of employees, as well as on their work-life balance, productivity, and morale.

As a member of the Responsible Business Alliance, Acer requires suppliers to comply with the RBA Code of Conduct and the [Acer Supplier Working Hours Policy](#). Through supply chain working hours policies, we communicate and cooperate with our suppliers to reduce excessive working hours in the supply chain and improve the health and morale of workers. For the status of supply chain working hours in 2022, please see the 2022 main issues and tracking improvements in this section.

Health and Safety - Chemical Substances Management in Supply Chain Processes

We have adopted the RBA Code of Implementation and require our suppliers to employ effective chemical substances management systems and comply with local regulations to effectively classify, store, use, and dispose of chemicals, as well as to provide workers with appropriate protective equipment and training.

Since 2019, the list of chemical substances prohibited in our processes includes toluene, benzene, beryllium dust, chlorinated organic solvents, m-hexane, N-methyl-2-pyrrolidone (NMP), and substances harmful to the ozone layer, as these chemicals can affect the external ecosystem or the health of workers, and will be included in the focus of the annual on-site audits.

In 2021, we coordinated with the RBA to further revise the controlled chemical substances list and requesting suppliers to comply with the new list. We confirm the implementation of this effort through on-site audits in 2022.

We also continue to pay attention to specifications set out by relevant industries, evaluate expanding the scope of this inventory, reduce the risks faced by workers and the environment, and strengthen both communication and checks in on-site audits.

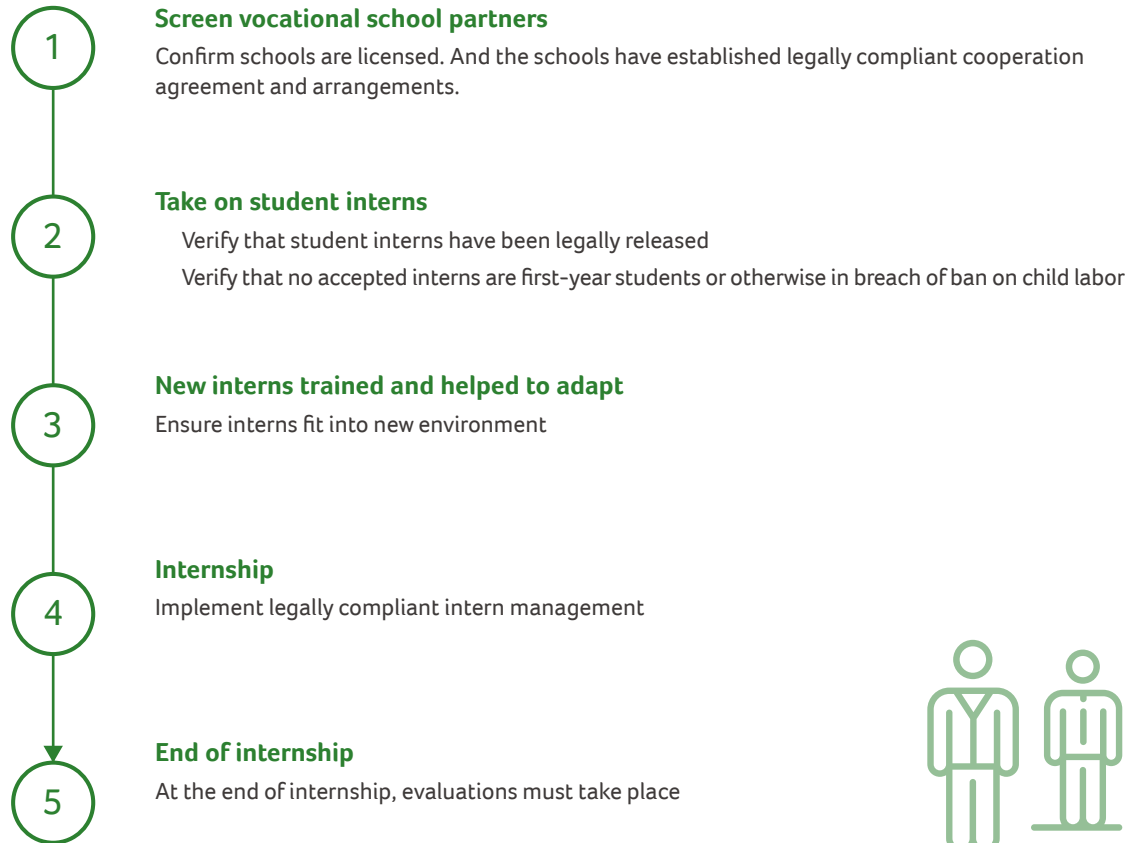



| Responsible Sourcing of Minerals

Responsible minerals sourcing continues to be a major focus for Acer. We believe that it is our responsibility to respect the human rights of others and to address adverse human rights impacts that exist where we do business and within our area of influence. As a program that began with a focus on tantalum, tin, tungsten and gold (3TG) in the Democratic Republic of the Congo (DRC), Acer's Responsible Minerals Sourcing program has expanded to a program capable of addressing any minerals identified by Acer that involve social and environmental risks.

In 2022, Acer's responsible minerals sourcing program continued to include 3TG, cobalt, and mica as prioritized minerals in its responsible sourcing strategy. These determinations are based on the prevalence in our products and the sourcing from Conflict-Affected and High-Risk Areas (CAHRAs). Acer will continue to reassess its priority minerals as well as be involved in the refining of the procedures to identify CAHRAs. In 2022, Acer issued its fifth consolidated responsible minerals report, outlining the steps taken to conduct due diligence on all of its priority minerals.

2021 Responsible Minerals Report

In 2022, we completed and published our 2021 Responsible Minerals Report, including a summary of Acer's responsible minerals supply chain due diligence, future plans, smelter or refiner (SOR) list and mineral country of origin. The report showed progress over the previous year. Acer's 3TG goal in 2021 was that 98% of SORs shall be conformant to an OECD-aligned 3rd party assessment program and 100% shall be either conformant to or participating in an OECD-aligned 3rd party assessment program. Acer was able to achieve its goal of a 100% conformance or participating rate. However, due to operational status fluctuations in the tin supply chain affecting conformant status, Acer achieved 91% conformant rate, missing its goal of 98% conformant.

For cobalt, Acer saw an increase of identified processors from 21 to 62, 61% of which were either conformant or participating in an OECD-aligned 3rd party assessment program. For mica, it was the first year conducting due diligence and while processes were put in place and supply chain tracing was conducted, the first year resulted in only a few identified processors. It is expected that in the coming years the identified processors for cobalt and mica will increase and Acer will continue with processor outreach to increase participation in the RMAP. To review the results of these activities, please refer to Acer's most recent [2021 Responsible Minerals Report](#).

2022 Due Diligence Results

Tantalum, Tin, Tungsten and Gold: As a result of our responsible minerals due diligence measures and the collection of supply chain information for the current 2022 data cycle, we were able to identify 244 unique smelters of 3TG in our supply chain. The quantity of conformant and participating (RMAP-committed) smelters was 244, which is equivalent to 100% of the identified smelters in our supply chain. A summary of our progress year-over-year can be found to the right.

	2018	2019	2020	2021	2022
Conformant	252	235	238	238	227
Participating Smelters	4	5	11	24	17
Smelters Requiring Outreach	6	2	0	0	0
Total	262	242	249	262	244
Percentage of Conformant Smelters	96%	97%	96%	91%	93%
Percentage of Conformant or Participating Smelters	98%	99%	100%	100%	100%

Cobalt and Mica: As part of its responsible minerals program, cobalt and mica are an additional focus for Acer. As a result of its due diligence measures in 2022, Acer was able to identify 62 unique cobalt refiners in our supply chain. The RMAP status improved to 33 RMAP-conformant, 9 participating and 20 that will require outreach. For mica, Acer was able to identify 6 unique mica processors, of which 3 are participating and 3 require outreach.

Other Activities: Acer also continued using the Risk Readiness Assessment (RRA) tool offered through the Responsible Business Alliance (RBA). The tool allows Acer to compare smelters' and mines' performance across 32 issue areas covering environmental, social and governance aspects of mining and refining operations, improving our ability to assess and manage risk in our minerals supply chain. At the same time, it allows Acer to engage with suppliers further up the supply chain, which has been a challenge, and also allows the smelter to connect with and have visibility of the downstream companies that use the materials that they place on the market. This helps to emphasize the value of the RMAP certification. At the time of the writing of this report, Acer has received RRAs from 100 processor facilities. The RRA covers the following metals and minerals: Aluminum, Alumina, Bauxite, Cobalt, Copper, Gold, Graphite, Iron Ore, Lead, Lithium, Mica, Molybdenum, Nickel, Palladium, Platinum, Rare Earth Elements, Silver, Steel, Tantalum, Tin, Tungsten, and Zinc.

Acer continues to follow the OECD Due Diligence Guidance as the basis for its conflict minerals management program and seeks to implement program elements that strengthen Acer's conformance to those guidelines. We also continue to conduct smelter outreach and communicate smelter details and the results of our efforts to the Responsible Minerals Initiative (RMI) Smelter Engagement Team (SET), as we believe the smelter/refinery identification and disposition are critical components of our due diligence procedure and of maintaining RMAP smelter data. Acer is a member of the SET team and conducts research on global alleged smelters to help determine if they meet the definition of smelters and if they are eligible for the RMAP program.



Environmental Management: Supply Chain Climate Engagement

Acer's zero-carbon commitment represents not only Acer's determination to promote zero-carbon emission, but also its vow to collaborate with the supply chain to take positive actions to achieve low-carbon transformation. We are committed to reducing value chain carbon emissions by 35% by 2030 compared to the 2020 base year through supplier climate initiatives, supplier climate capacity building, and supply chain greenhouse gas management strategies.

Earthion Initiative

In 2021, we brought together our employees and supply chain partners to expand the reach of sustainability efforts by launching the Earthion initiative, with the goal bringing everyone together to create a better future and achieve our ambitious goal of a clean planet. Through the Earthion Sustainability Platform, we share the spirit of sustainability with our partners and suppliers, helping to address the environmental challenges of our generation through innovative and integrated solutions. To this end, we are focused on innovative green product design, chemical substance management in production processes, renewable energy use, low-carbon emission logistics, packaging materials and design, and product recycling & reuse, combining the efforts of our suppliers and partners to accelerate the development of green designs and processes and completely minimize our environmental impact.

For example, we are working with our designers and partners, including Golden Arrow, ShinShin, SunYoung, Quanta and Wistron, to find innovative ways to use environmentally friendly materials without sacrificing the durability and robustness of our products, targeting up to 30% post-consumer recycled plastic content for our core products by 2025. We are collaborating with Compal and Quanta to enhance our waste management system to remove the excess security tape used in the pallet packing process, which is expected to save approximately 5,500 kilometers of tape by 2023, which in total is about the distance from London to New York. We have partnered with logistics partners such as DHL to build a transportation carbon inventory system and improve the accuracy of our transportation carbon calculations through a unified approach to measuring and reporting Acer's greenhouse gas emissions during transportation.

Through the Earthion Sustainability Platform, we share the spirit of sustainability with our partners and suppliers, helping to address the environmental challenges of our generation through innovative and integrated solutions. To this end, we are focused on innovative green product design, chemical substance management in production processes, renewable energy use, low-carbon emission logistics, packaging materials and design, and product recycling & resource reuse, combining the efforts of our suppliers and partners to accelerate the development of green designs and processes and completely minimize our environmental impact.

Climate Capacity Construction

We offer information and training on the latest trends and developments in social and environmental responsibility, helping suppliers better confront the challenge of sustainable development. We continue to invite suppliers to participate in annual supplier ESG communication meetings, CDP project briefings, and major training programs on social and environmental responsibility. This helps them get access to the latest information on global trends, while also presenting opportunities for suppliers to engage in multilateral communication with Acer senior management or relevant industry experts. We invite major suppliers to take part in annual ESG Communication Meetings, where we share the latest global trends in corporate sustainability, human rights issues, and climate mitigation and adaption measures, along with Acer's requirements of and goals for supply chain ESG management performance.

In 2022, we focused our communication on the digitization of carbon management, and through the new e-ARSM Acer Responsible Supply Chain Management System and Life Cycle Assessment (LCA) carbon footprint system, we will effectively collect and manage carbon emissions at the supply chain end to build the foundation for the company's net-zero carbon emissions promotion.

We also invite our corporate partners, suppliers and their employees to join Acer's "21-Day Challenge" initiative. With a dedicated mobile app, we record each participant's green actions, track the amount of Carbon Emissions reduced during the process, and together we cultivate the habit of reducing, reusing and recycling to expand our impact on the environment.



Supply Chain Greenhouse Gas Management

Acer has joined the CDP supply chain system since 2008, and has further used the ESG scorecard to review suppliers' performance in overall carbon management, carbon reduction results and renewable energy usage, and to manage the environmental impact caused by the supply chain, and to include supplier scores in procurement evaluations to promote the overall supply chain to improve its ability to respond to climate change.

In 2022, Acer has been ranked A- on the CDP Supplier Engagement Rating (SER) for three consecutive years, and 60% of our Critical Suppliers have committed to RE100 or science-based carbon reduction targets (SBT), in line with expected targets.

Acer has been inviting second-tier suppliers to join the CDP Supply Chain Program since 2019, and started officially inviting third-tier suppliers to participate in 2022, identifying supplier climate risks and opportunities through supplier surveys responses.

In terms of supply chain responses, 94% of our Tier 1 suppliers have included climate issues in their board-level oversight, 84% have integrated carbon management into their operations and developed carbon reduction plans consistent with the 1.5°C reduction pathway scenario, 86% have taken carbon reduction actions, and 67% are using renewable electricity.

We will continue to communicate with Tier 1 and Tier 2 suppliers and work with ODM Suppliers to further influence Tier 3 suppliers, jointly pulling upstream suppliers to deepen the growth potential of carbon management in the industry chain.

Percentage Achieved by Supplier

% of Supplier	2019	2020	2021	2022	2022 (First-tier Suppliers)	2022 Global Supplier Average Performance
Overall Average Level	C	C	C	C-	B-	D
Average % of reporting scope 1 and scope 2 emission	86%	81%	93%	81%	94%	80%
Climate Risk Assessment	83%	80%	86%	74%	88%	66%
Integrating climate-related issues into business strategies	84%	82%	86%	71%	84%	73%
Emission reduction target	80%	76%	81%	60%	80%	68%

Note: 284 CDP supply chain members, invited suppliers = 40,700, actual responses = 16,482

Supply Chain Audit and Improvement

Acer uses risk assessment results of the ESG scorecard as the basis for performing on-site audits and assessments. We examine the country risk, manufacturing processes, and products of each supplier, along with results of previous audits, as well as taking into account the concerns of stakeholders when setting out our annual audit plan.

Supplier ESG scorecard

We implement Supplier ESG scorecards to review Supplier ESG practices and performance. This score is included in quarterly business review (QBR) for key product lines and critical components, and is presented to Acer and Supplier senior executives to create a driving force in the business relationship.

Assessment Items for Corporate ESG Scorecard

<ul style="list-style-type: none"> Corporate Sustainability Management <ul style="list-style-type: none"> Corporate Governance Stakeholder Communication Supply Chain Management Labor, Ethics, Health, and Safety Management <ul style="list-style-type: none"> Management Systems Certifications Conflict Minerals Management RBA Code of Conduct Audit Scores 	<ul style="list-style-type: none"> Environment, Energy, and Climate Change Management <ul style="list-style-type: none"> GHG Inventory GHG Reduction Carbon Disclosure Supply Chain Project Rating Scores Usage of Green Electricity and Renewable Energy Status of Science-based Carbon Reduction Targets Environmental Problems Energy management
--	---



The overall performance of suppliers on the ESG scorecard in 2022 continued to improve and increase, with 67% of suppliers achieving an “excellent” standard and 27% at the “medium” level. We also use quarterly business reviews and other communication methods to demand that underperforming suppliers implement appropriate actions to improve their ESG performance. This mechanism will continue in the future, and according to internal and external issues and past performance, we will make any necessary adjustments to weighting or items to be assessed.

2022 On-Site Audit Results

Acer’s suppliers must treat their staff in a respectful manner, using environmentally responsible manufacturing processes and providing safe working conditions. We have adopted the latest version of the RBA Code of Conduct, which covers the five major aspects of labor, health and safety, the environment, ethics, and management systems.

This system is used in our on-site audits of suppliers with regard to both social and environmental responsibility. Through different auditing methods adopted based on the particular nature of the supplier’s operations and their implementation of the RBA Code of Conduct, we can verify any lapses in the aforementioned five areas and require suppliers take corrective steps by a given deadline. Thus we are able to continually improve the social and environmental responsibility of Acer’s supply chain.

For suppliers with priority deficiencies or difficulties in proposing improvement solutions, we will discuss and track progress by phone or videoconferencing to ensure the timeliness and effectiveness of improvement measures.

If, after review, there are still significant hidden issues, we will refer the procurement department to take necessary actions, including inclusion in QBR meetings of senior managers of both suppliers and purchasers, order adjustments or replacements, etc.

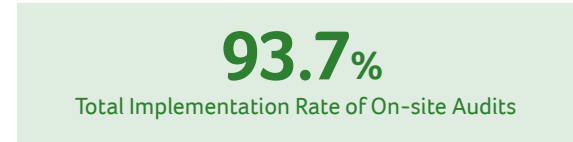

In 2022, we conducted a total of 105 audits, 100% of which were on-site audits. These include two new suppliers that began production of Acer products in 2022. Meanwhile, one supplier that failed to meet Acer’s social and environmental requirements was removed. Implementation methods include: third-party audits (CMA or AMA), RBA Validated Audit Process (VAP), BSCI, SA-8000, accreditation, etc.

During this period, the impact of COVID-19 has been influenced by the actual changes in the epidemic, therefore, a flexible combination of desktop audits has been conducted as an alternative. We particularly encourage suppliers to undergo the Validated Audit Process (VAP) themselves, resulting in a broader scope of application of audit results that can help boost overall industry responsibility and compliance. In 2022, more than 260,000 direct Supplier employees were audited and 4,318 direct employees were interviewed, with more than 80% using the RBA Validated Audit Process (VAP).

Settlements were audited within the two-year validity period, with an overall implementation rate of 93.7%.

For the 2021 RBA audit with a total score of less than 120 (out of 200), there were 3 companies with higher risk. We have held several online improvement plan discussions and progress review meetings to provide immediate and effective assistance with feasible solutions and technical advice. One of the suppliers, due to a serious lack of relevant expertise, has significantly and effectively improved its overall systems and capabilities after eight intensive senior-level communications, executive manager coaching and reviews. The Supplier performed the third-party review audit again in 2022 after achieving concrete improvements. There were 3 on-site factory audits, with a total audit rate of 100%.

Percentage of Audits of Higher Risk First-Tier Suppliers

100 %

VAP Audits Performed by a Third Party

Per the above description, between 2008 and 2022 a cumulative total of 986 first-tier Supplier audits have been carried out. In addition, to effectively improve implementation through the supply chain, Acer has required its first-tier suppliers to conduct pre-audit risk assessments of their next-tier suppliers of critical raw materials since 2017. After aggregation, high-risk suppliers accounted for 6% of the total, with medium-risk suppliers at 22%.

We continued to carry out auditing activities in 2022 along these lines, auditing a total of 893 second-tier factories. In 2021, we deepened our implementation across the supply chain, extending our auditing activities to third-tier suppliers, of whom we conducted 422 audits in 2022.

In 2023, we still plan to conduct on-site audits of 70 first-tier supplier manufacturing plants, covering 140,000 direct employees and interviewing 2,500 other employees. The annual RBA site audit compliance targets are: labor: 87%, health and safety: 87%, environment: 95%, ethics: 95%, management systems: 95%.

We will continue to pursue auditing activities for second- and third-tier suppliers to actively improve the workforce and operating environment and deepen the long-term positive impact on the overall supply chain.

Supplier Audit Categories and Number of Audits, 2018-2022

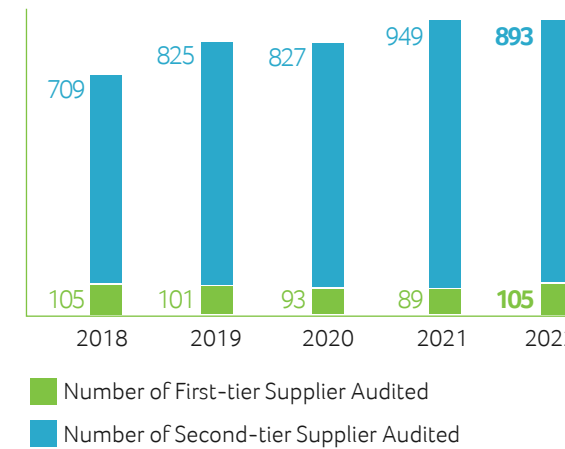

Manufacturing Supplier Direct Employees and Cumulative Direct Employees Audited, 2018-2022

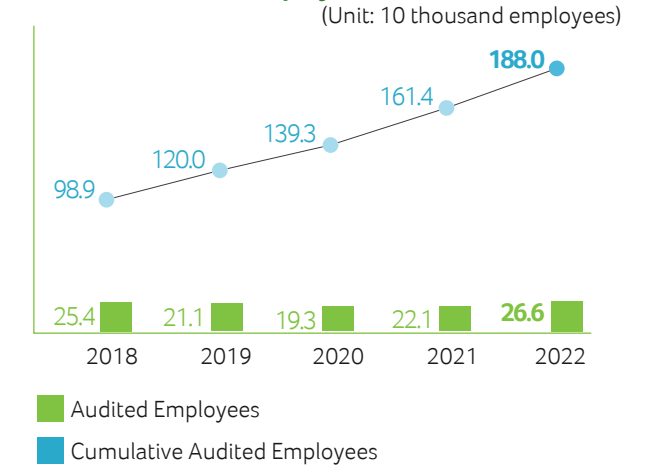

Cumulative Total Audits

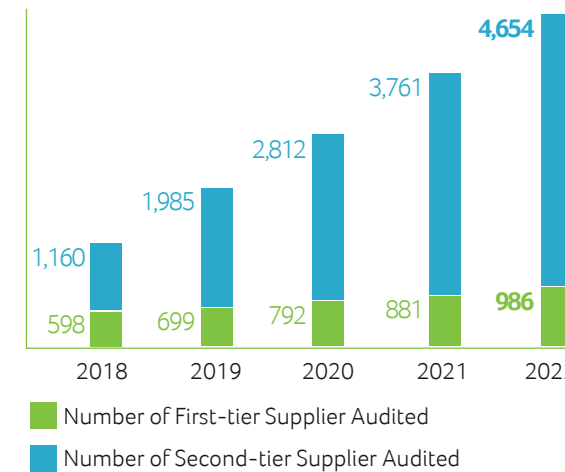

Manufacturing Supplier Employees and Cumulative Direct Employees Interviewed and Audited, 2018-2022

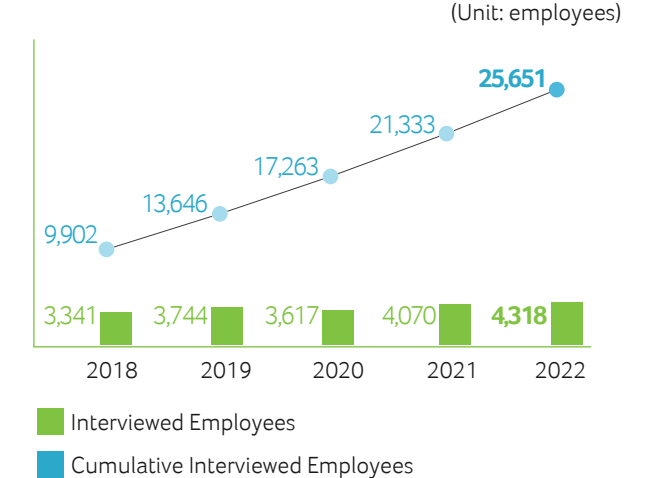

Note 1: First-Tier Supplier Audits = VAP (or SA8000) + Full Audit + Surveillance Audit

Note 2: Cumulative First-Tier Supplier Audits = Cumulative First-Tier Supplier Audits (Previous Year) + First-Tier Supplier Audits (Current Year)

Note 3: Cumulative Total Audits = First-Tier Supplier Audits + Second-Tier Supplier Audits + Cumulative Total Audits (Previous Year)

Note 4: The statistical period for each year is October 1 of the preceding year to September 30 of the current year, totaling 12 months.

2022 Audit Results Analysis

From on-site audit results, we see that the greatest proportion of non-compliance occurred in labor issues, followed (in order) by health & safety, environmental, management system, and ethics.

Distribution of Non-Compliance Found in Audits



Significant Deficiencies (defined as Priority Non-Conformances) and Other Deficiencies (by Category)

Category	Significant Deficiencies	Other Deficiencies
Labor	0.2%	10.5%
Health and Safety	0.4%	5.3%
Environmental	0%	2.7%
Ethics	0%	0.4%
Management	0.1%	1.2%

RBA Code of Conduct Conformance



Note: Data covers all suppliers subject to audits by Acer management, third parties, and VAP, a total of 98.

Important Issues and Tracking of Improvements in 2022

The main lapses in terms of labor rights were problems around working hours and pay. Other issues were related to lapses in control of hazardous substances, potential hazard controls, and Supplier audit management.

The main deficiencies in working hours are: Although overtime and a small number of personnel working long shifts are still the main deficiencies, in the post-epidemic era, production and scheduling have normalized due to abundant raw material inventory and slowing market demand, so the demand for emergency manpower has decreased significantly, which has led to a significant alleviation and improvement of the overtime problem. In response to future manpower changes, the supplier continues to pursue strategies such as process automation, duty scheduling optimization, multi-skilled worker training and reward system to improve the flexibility of manpower scheduling in the long run.

With regard to labor wages and benefits, the main problem is that social insurance coverage is not fully available to all employees. With strong communication and supervision, we have made significant improvements in 2022. At present, the main problem is that the insurance coverage of new employees still needs to be improved. Therefore, in response to the new changes, the implementation strategy is adjusted and the focus of the audit is changed to whether the new employees have proper insurance-related education and training to enhance their personal intelligence for the promotion of comprehensive insurance operations. In addition, although there are no outstanding cases of unpaid salaries in a small number of factories, the timeliness needs to be further improved due to the complicated and lengthy operation procedures. In addition to requesting suppliers to adjust and improve in a timely manner, it is also included as a key item in the continuous tracking and inspection.

In terms of environmental safety and health deficiencies, the main problem is that the fire-fighting facilities, escape doors, and signage in the factory were not thoroughly inspected and internally audited when they were re-opened after a period of discontinued production, resulting in some of the lights malfunctioning or being locked. To eliminate the potential for occupational hazards as much as possible, in addition to educating suppliers to include this in their implementation, we have placed special emphasis on this audit in 2022.

In terms of hazardous substance management, the main issue is that the temporary storage area is not stringent in terms of chemical packaging, retrieval and labeling. Also, chemical liquids were not properly set up in secondary containers when stored so as to prevent the risk of leaks. Suppliers are required to include this operation as a daily internal inspection highlight.

In terms of management system, suppliers are more likely to be negligent in the management of non-direct production related services, such as manpower dispatch, canteen, cleaning and security, etc. We continue to promote this management highlight and include it in our counseling and tracking.



Acer issues Corrective Action Reports (CAR) to higher-risk audited suppliers in response to any issues of non-compliance identified. Within 30 days of receiving such reports, suppliers must produce a written risk CAR of their own and submit it to Acer for approval by management personnel. These reports will be followed up on each month and verified against the on-site audit the following year. With regard to high-risk suppliers, as found in the audits, Acer will make the necessary adjustments to our purchasing strategy to manage the issue. As of the end of 2022, 210 deficiencies have been identified in higher-risk suppliers with VAP audit scores below 160 or priority non-conformance deficiencies, and as of December 31, 2022, 210 deficiencies have been tracked and improvement measures have been implemented. A total of 15 deficiencies including priority non-conformances were listed, and all of them have been listed for corrective action, the implementation rate of which is 100%. The other non-conformances have also been listed for corrective action, the implementation rate of which is 100%.

100%

Percentage of Priority Non-Conformance with Corrective Measures Implemented

100%

Other Non-Conformances with Corrective Measures Implemented

Important Issues and Corrective Actions for On-site Audits

Labor	Health and Safety
<p>A3.1 & A3.2 Working Hours Workweek exceeded 60 hours; Workers were not allowed at least one day off in seven days</p> <p>Corrective Action Verification</p> <ul style="list-style-type: none"> • Strengthen multi-skill training to enhance manpower flexibility • Establish high performance output bonuses to replace long hours with high output performance • Implement rotating shift duty system • Implement attendance overtime control system with new functions for pre-warning notification and tracking. • Purchase automated equipment to reduce dependence on manual labor <p>A4.2 & A4.4 Wages and Benefits</p> <ul style="list-style-type: none"> • Correctly calculate payroll deductions or submit them to the government in lieu of deductions • Salary settlements for departing employees are not settled in time <p>Corrective Action Verification</p> <ul style="list-style-type: none"> • Promote the meaning and importance of social insurance payments during the onboarding of new employees • Encourage employees to participate in social insurance in accordance with the law to ensure that all employees are insured in accordance with the law • Adjust payment basis in a timely manner and in strict accordance with local regulations • Simplify and speed up the payroll settlement process for departing employees <p>A1.1 Freely Chosen Employment Labor which is not forced, forcibly confined, indentured or in bondage, trafficked, or enslaved</p> <p>Corrective Action Verification</p> <ul style="list-style-type: none"> • Providing training on RBA Code of Conduct for outsourcing and staffing suppliers • Comprehensive audit of medical examination fees and employee medical examination advancement system for outsourcing and staffing suppliers 	<p>B2.1 & B2.4 Occupational Safety</p> <ul style="list-style-type: none"> • Properly maintain emergency exits and access • Maintenance and inspection of fire safety facilities <p>Corrective Action Verification</p> <ul style="list-style-type: none"> • Discontinued plants are included in the scope of routine inspection • Regular maintenance and renewal of safety and fire protection facilities in idle plants • The re-opening of the plant shall be subject to prior internal audit and acceptance
Environmental	
<p>C3.1 Hazardous Substances Use qualified suppliers for proper sorting, labeling, handling, storage, transportation, and disposal of hazardous substances/waste</p> <p>Corrective Action Verification</p> <ul style="list-style-type: none"> • Addition of hazardous materials disposal suppliers to improve efficiency of hazardous materials disposal • Harmful substances are to be stored according to the law in secondary containers to prevent leakage • The chemicals in the explosion-proof cabinets in the temporary storage area must be packed in limited quantities, collection and return and labeling are included in the daily audit highlights. 	
Management Systems	
<p>E12.2 Supplier Responsibility Adequate and effective processes to ensure Supplier implementation of RBA guidelines</p> <p>Corrective Action Verification</p> <ul style="list-style-type: none"> • Scope of management is too narrow. Re-inventory and include suppliers of labor services (e.g., temporary labor, canteen, cleaning, security, etc.) in supplier management scope • Strengthen the process of auditing supplier control process to prevent incomplete supplier self-assessment reports and missing improvement reports 	

05

CIRCULAR ECONOMIES AND INNOVATION

Acer is committed to reducing the environmental impact of its products during the product life cycle by integrating the concept of circular economy. Acer gives the best effort to reduce the products’ environmental impact, and actively adopts low-carbon circular strategies such as innovative design, extending product life cycle, and effective use of materials in pursuit of a balance between product management and environmental protection. We are also committed to developing products that are beneficial to both the environment and people through obtaining patents to protect the Company’s R&D achievements and strengthening its core competitiveness.

· Acer’s Circular Economy Model	86
· Product Life Cycle	87
· Innovative Products and Services	96

30 million

More than 30 million computer and display products use post-consumer recycled plastics in 2020-2022

THIRD

Acer is ranked as No.3 domestic patent applicant in Taiwan for granted patents (with published and issued patent certificates)

Note: Ranked second in patent applications in Taiwan

17%

17% of post-consumer recycled (PCR) plastics used in computers and displays

Acer's Circular Economy Model

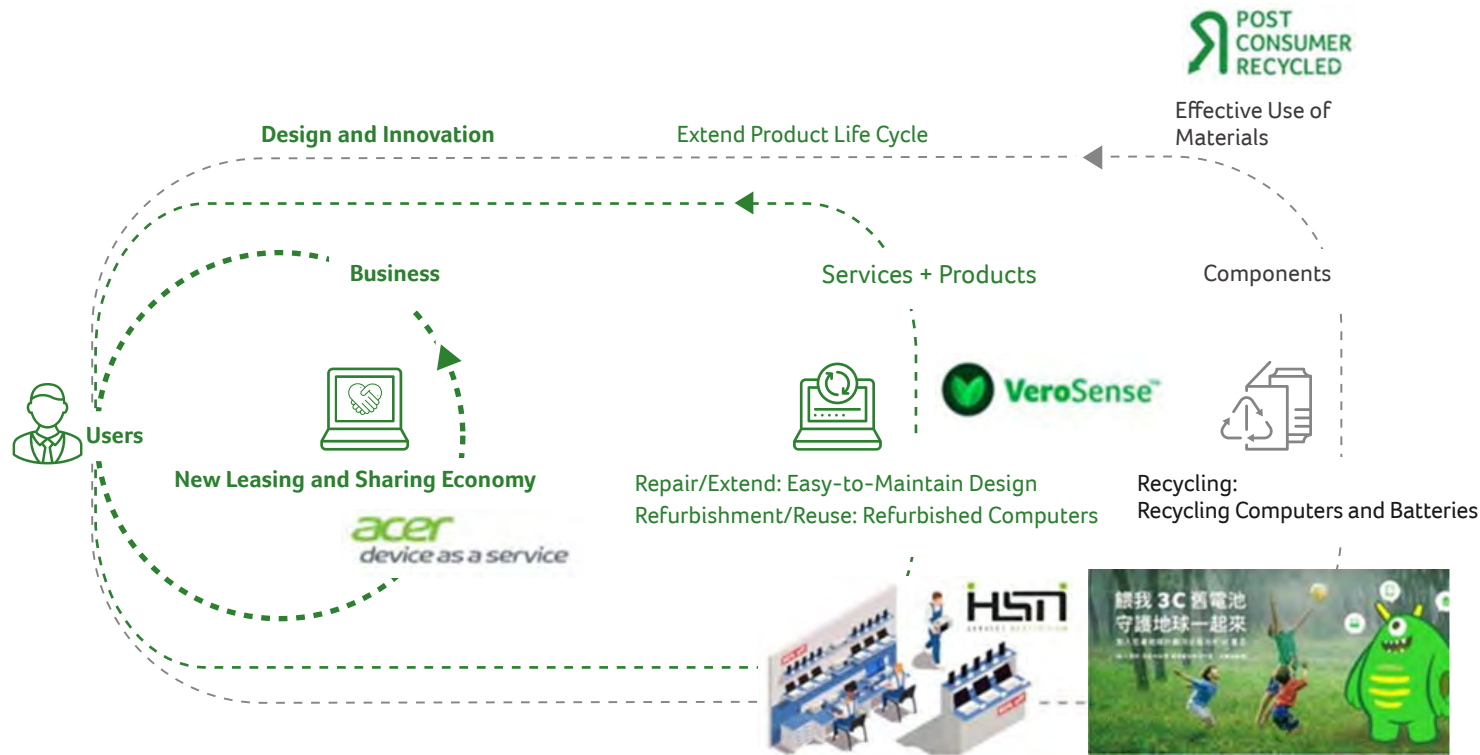

With the new business model of leasing and sharing economy, the services purchasing (rental) is replacing the purchase of hardware equipment such as the DaaS (device as a service) launched by Acer in the pan-European region. DaaS is a complete smart IT solutions with a simplified consumers contract, including hardware, accessories and software solutions for monthly or quarterly payment. Companies using DaaS can rapidly scale their equipment up or down to meet changing demands. Companies can access the latest technology and equipment without having to make large investments. This not only provides the optimal use of resources, but reduces the company's expenditure on IT equipment.

Through product maintenance and refurbishment, the product life cycle is extended as much as possible. For example, HSN, a subsidiary of Acer, provides global support, multi-brand testing, and manufacturer authorized repair and maintenance, from pre-purchase consultation, product function setting, warranty, maintenance, to product recycling at the end of the service life. HSN provides services in every step of the product life cycle, reduce the burden on enterprises and consumers, and improve product performance and reduce environmental impact. Acer's service center in Taiwan provides quick computer health diagnosis services or computer hardware upgrade promotion during certain periods of time such as the Chinese New Year or the Back to School season where consumers are advised to utilize hardware upgrades to extend product life cycles and reduce electronic waste.

At the end of the product life cycle, in addition to complying with local regulations for product recycling, Acer has implemented voluntary recycling programs, such as the Acer's Takeback Program in Taiwan. Through 23 service centers and the distribution network across Taiwan, Acer provides regular 3C recycling services for notebooks, mobile phones, tablets, batteries, etc. In addition, Acer actively uses post-consumer recycled plastics and ocean bound plastics in its designs to not only reduce the plastic waste that is difficult to process or may cause environmental pollution when electronic products are discarded, but to promote the development of a circular economy.

Circular economies differ from the traditional linear economy model in shifting to a cradle-to-cradle circular model that produces no waste. We can accomplish the goals of circular economies through several possible business models, including product sharing, device as a service, repair and refurbishment, remanufacturing, by-products and industrial symbiosis, replacement of raw materials with renewable materials, and resource regeneration and recovery.

Circular Economy and Product Stewardship

Indicators related to GRI/SASB
GRI : 301-1~3, GRI302-5 : TC-HW-410a.1~4

Policies/ Commitments

Through product life cycle management, Acer is able to both manage our products and reduce their potential impact on the environment. We actively strive to find a balance between product management and environmental performance to provide more environmentally and commercially competitive products.

Stakeholder Engagement and effectiveness

Publish product carbon footprint report and earn US ENERGY STAR certification

Action Plan

- Acer minimizes the environmental impact of our products and reduces emission and waste by implementing the concept of circular economy, including improving the energy efficiency, using recycled materials, and designing products and packaging with recycling in mind.

Tracking Mechanism

- Regular review by Corporate Sustainability Committee's Innovation and Product Life Cycle working group and report to the Corporate Sustainability Committee every six months

Medium- and Long-Term Goals



Product life cycle: Product life cycle are taken into account during development and design stages for all products



Energy saving, recycling, waste reduction: Minimize product energy consumption to exceed applicable energy specifications. Increase/continuous use of recycled materials to reduce environmental impact.



Sustainable packaging: design product packaging with sustainable materials

2022 Goals



Continue to publish carbon footprint reports for notebooks, desktops and displays

39%

Notebook energy consumption decreased by 39% and desktop computer energy consumption decreased by 34% compared with 2016 (The calculation has been revised, and the original target are 41% and 37% respectively)

34%

17%

17% of post-consumer recycled (PCR) plastics used in computers and displays

Status as of 2022



Completed product carbon footprint report for all commercial notebook products (including Chromebooks) and representative models of desktop and displays products

39%

35%

17%

Notebook energy consumption decreased by 39% and desktop computer energy consumption decreased by 35% compared with 2016

17% of post-consumer recycled (PCR) plastics used in computers and displays

2023 Goals

18.5%

18.5% of post-consumer recycled (PCR) plastics used in computers and displays

42%

38%

Notebook energy consumption decreased by 42% and desktop computer energy consumption decreased by 38% compared with 2016

Product Responsibility and Customer Safety

Policies / Commitments

Providing customers with safe products, developing our creative capabilities, and introducing new solutions are all ways in which we can protect our customers' health and safety.

Stakeholder Engagement and Effectiveness

Launch Vero products

Action Plan

- We follow safety and hazardous substance related regulations during the product development and manufacturing stages to provide safe and environmentally friendly products to users.

Tracking Mechanism

- Regular review by Corporate Sustainability Committee's Innovation and Product Lifecycle working group and report to the Corporate Sustainability Committee every six months

Medium- and Long-Term Goals



Transparency and Monitoring:
Trace the source of materials and hazardous substances to effectively control the risk of possible harm to the human



Responsible manufacturing:
Monitoring of hazardous substances/ Materials, phasing out the use of environmentally sensitive substances gradually

2022 Goals



Increase the use of recycled plastics in notebook products



Applications of Bioplastics

Status as of 2022



In line with Vero product line, we use non-coated recycled materials for notebooks, desktops, displays, projectors and peripheral products.



The research and prototype of bioplastic materials are completed, and the applicability of the notebook product line is currently under evaluation

2023 Goals



The material for the educational product line is designed with consideration of customer health

Product Life Cycle

Acer is committed to reducing the environmental impact of its products during the product life cycle by integrating the concept of circular economy.



Design

Chemical Substance Management

To comply with regulatory requirements and customer standards, Acer integrates environmental and safety-related regulations in the product development stage, and through a rigorous review process, ensures that all production stages of the supply chain meet environmental and safety-related requirements.

To protect the health and safety of users and reduce potential environmental risks, Acer strives for prudent management of chemicals in the products. In accordance with the Declarable Substance List of IEC 62474, Acer has categorized the chemical substances into three categories: "banned substances", "restricted substances" and "disclosure substances", and formulated the "Guidance of Restricted Substances in Products", which is reviewed every year and revised as needed. In addition to the requirements of the RoHS directive, REACH and POPs persistent organic pollutant regulations are also included, requiring suppliers to comply and confirm their compliance before mass production.

Use of Post-Consumer Recycled Plastics and Ocean Bound Plastic

Acer not only supports the concept of resource recycling, but also actively uses post-consumer recycled (PCR) Plastics in its products.

The Company determines the types and ratios to be used during product planning and carefully select vendors; For products using post-consumer recycled plastics, we ensure that the raw material formulation is as close as possible to the physical properties of the virgin plastic. When necessary, we add strength and reliability design to the product design process to ensure product quality. Users can not only enjoy the same quality of products as virgin plastic, but also support the reuse of resources together with Acer to strengthen the concept of circular economy. In 2022, 17% of post-consumer recycled plastics were used in computers and displays, and we extended the application to projectors, computer peripherals and other products.

A total of more than 30 million computer and display products use post-consumer recycled plastics from 2020-2022.

In addition, Acer attached great importance to the issue of marine waste plastic pollution. Acer uses recycled ocean bound plastic (OBP) and converts it into recyclable materials. Starting from 2021, ocean bound plastics had been utilized in notebook products to make Ocean Glass touchpads, which are currently used in the Chrome, Swift, Aspire Vero, Travelmate P2 and other product series. At the same time, Acer conducts feasibility studies on the use of ocean bound plastics in other parts. Though the application to other parts do not have the economic benefits after evaluation, Acer will continue to explore opportunities to expand the use of ocean bound plastics in the future and emphasizes this issue together with consumers.





Packaging

Use of environmentally friendly materials with streamlined design

Through the Acer Packaging Design Principles, we are able to examine the life cycle of our packaging and make informed decisions about the environmental impact of our packaging at every stage, from initial R&D and selection of materials through fabrication and transportation, to use and eventual waste processing. For example, we are reducing the volume and weight of packaging by simplifying packaging, standardizing package sizes and printing, and further reducing energy consumption for transportation.

In 2022, the entire line of notebook products has removed the external heat-shrinkable film of the printed document package and the transparent plastic bag of the power cord. For non-gaming models, the use of disposable plastic packaging materials such as plastic handles has been eliminated, reducing a total of 593 tonnes of plastic packaging materials in 2022. Taking 15-inch notebooks as an example, for every 10,000 units shipped, 890 kg of plastic packaging materials can be reduced. We also adopted about 135 tonnes of FSC-certified paper for the operation instructions attached to the products in 2022. Acer will continue to remove the outer cartons of notebook R&D prototypes and adopt material sharing to minimize carton types and wastes.

In the past, with the large size and heavy weight of desktop computers, the cushion materials were mostly limited to Styrofoam or EPE for protection and buffer. Acer is also trying to use paper cushion materials instead of Styrofoam or EPE to reduce the use of disposable plastic packaging materials. Thus, compared with 2018, the proportion of shipments using paper cushion materials has increased from 12% to 31% in 2022. In 2023, Acer plans to introduce paper cushion materials to two new commercial product series and small gaming models.

As for displays which are heavier and larger than notebooks and desktop computers where most of the cushion materials are still made of Styrofoam to ensure the cushioning and buffer for protection, there are five models in 2022 that have adopted paper cushion materials in line with the product strategy, and it is expected that more models will use paper cushion materials in the future.

Based on supplier information, Acer estimates that in 2022, a total of 7,322 tonnes of paper packaging materials (including cartons and paper cushion materials) were shipped along with the notebooks, desktop computers, and displays.

Green Packaging Policy

<h2>Recycle</h2> <p>Most Effective and Recyclable Packaging Designs</p>
<h2>Reduce</h2> <p>Reducing Use of Materials</p>
<h2>Reuse</h2> <p>Make Use of Reusable Materials</p>

Acer continued to make use of environmentally friendly packaging for our notebook computers

<h4>Cardboard Boxes</h4> <h1>90%</h1> <p>Made from recycled paper</p>	<h4>Moulded Pulp</h4> <h1>100%</h1> <p>Made from recycled kraft paper</p>
<h4>Polyethylene foam (EPE)</h4> <h1>100%</h1> <p>Made from recycled low-density polyethylene (LDPE)</p>	<h4>Posters</h4> <h1>FSC</h1> <p>Made from FSC certified paper</p>
<h4>Printed Matter</h4> <h1>40%</h1> <p>Made from recycled paper</p>	<h4>Non-woven Fabrics</h4> <h1>100%</h1> <p>Made from recycled PET</p>



Packaging

Aspire Vero notebook green packaging design won Red Dot Design Award for Packaging Design



reddot winner 2022
packaging design

In 2022, Acer Aspire Vero packaging design maintains the concept of reducing and reusing plastic, replacing heat shrinkable film and plastic bags with recycled paper, and improving the functionality of reusable packaging materials. For example, the package box can be easily assembled and repurposed as a storage box, and the internal partition can be turned into a notebook stand with just a few simple steps. Furthermore, the paper tray and cushion can be used as nursery pot, prolonging the lifespan of the package material that should have been discarded after unboxing, and echoing Acer's concept of circular design.

The package box for this year uses 90% recycled pulp where 100% recycled pulp is used to make molded pulp cushion materials. The notebook sleeve and the protective sheet between the keyboard and the screen are all made of 100% recycled PET material.



Distribution

Improve the efficiency of Product Shipping Efficiency

Every day, tens of thousands of Acer products make their way to consumers' hands. Acer strives to reduce the volume and weight of our packaging, thus improving transportation efficiency and reducing the fuel consumed in the course of transport. This helps further reduce the carbon emissions generated during transport, while also reducing the overall cost of that transport. We have reduced CO₂ emissions by changing our distribution modes and improving our supply chain management.

Changing Shipping Modes

After Acer notebooks are manufactured in Chongqing, Acer continues to implement land transportation optimization through close collaboration with logistics suppliers. In 2022, 58-foot trucks were used to consolidate 40-foot and 20-foot shipping containers to Shenzhen, achieving a consolidation rate of 85% and saving more than 700 trips. With each trip of about 1,600 kilometers from Chongqing to Shenzhen, the annual carbon reduction exceeds 528 tons.

Acer's products are directly or indirectly delivered to customers by marine transportation. In 2022, the proportion of air freight dropped from 18.8% in 2021 to 5.9%, which is equivalent to a carbon emission reduction of 70,000 tons. To further reduce carbon emissions in transportation, Acer piloted the transportation of biofuel in Q4 of 2022 and collaborated with the logistics supplier KUEHNE+NAGEL to transport 50 standard shipping containers from China to Europe, reducing a total of 40 tons of carbon emissions. Also, environmentally friendly notebooks shipped from China to Malaysia have begun to use biofuels for transportation.

Improving Supply Chain Management

In addition to two major suppliers that are already members of the GLEC (Global Logistics Emissions Council), Acer's logistics suppliers' measures for low-carbon issues in 2022 includes more than 50% of the major suppliers collaborating with EcoTransIT to provide a more comprehensive carbon emission data. It is expected that more logistics suppliers will join and use the industry standards to provide higher quality data.

In the future, Acer expects to pilot new energy electric vehicles in China and continues to promote biofuels in marine transportation to reduce carbon. At the same time, Acer will promote carbon reduction benefits to customers, and increase the use of new energy through customer participation to achieve carbon reduction goals and ultimately raise the awareness on carbon issues for all logistics suppliers. In addition to joining GLEC and EcoTransIT to improve carbon data collection, the logistic suppliers are required to invest in carbon reduction solutions for low-carbon transportation, and to combat climate change with Acer.



Use

Circularity and Energy Saving

With the development of the new business model of circular economy and sharing economy, we have also reduced the capital expenditure expenses of the Company's one-time purchase model by replacing the purchase of hardware equipment with the purchase of services (rental), and instead flexibly incorporating the required hardware, software and even maintenance services through contracts that can be adjusted according to demand. From the perspective of product design, we use modular design to achieve easy disassembly, easy maintenance or refurbishment, easy recycling, and even sharing of materials to effectively use resources to extend the product life cycle.

In addition, the product's energy efficiency has always been one of the key indicators in our product design. We use the US ENERGY STAR standard as the basis for product design and will continue to offer more low energy consumption products to consumers. With the introduction of the Modern Standby power management, the typical energy consumption ETEC of notebooks and desktop computers decreases.

Compared to 2016, we have reduced the average energy consumption of our notebook products by 39% and our desktop products by 35%, which also represents a reduction in the carbon footprint of our products during the usage. In the future, the Company will continue to provide more low-energy products and move toward the goal of reducing the average energy consumption of personal computer products by 45% by 2025.

Circular Production Models

Acer established the "Earth Project" to promote global reuse and recycling in 2018. Acer can reduce resource exploitation through recycling; at the same time, the risk of data leakage is also reduced by physically destroying storage devices to protect privacy. Net income received from recycling in Taiwan is used to support the Taipei Orphan Welfare Foundation with the hope that more children who have lost their parents will be able to receive a good education. In this way we support the sustainable development of society and the environment at the same time.

To reduce exploitation of and dependence on raw materials and move toward a circular economy, this Taiwanese recycling activity works with professional recyclers. After the batteries have been sorted, lithium batteries undergo extraction and manufacturing to form raw materials for new products, reducing exploitation of upstream raw materials. The remainder undergoes final processing in line with detailed specifications of technologically outstanding Taiwanese processors to prevent waste from going to third world countries and jeopardize their land or people.

In 2022, Acer expanded its invitation to service partners to join the recycling of circular production, encouraged partner manufacturers to participate in charity through recycling and issuing certificates of appreciation. At the same time, Acer held recycling competitions in service centers across Taiwan and rewarded the top 3 recycling service center with the highest recycled volume. In October 2022, Acer supported the supplier Compal Computer to hold a company-wide physical recycling event, with a total of 114 participants. In December, Acer held a group-wide recycling event "2022 Love Recycle" and added second-hand cloth recycling to attract employees to participate in different aspects.

In 2022, the recycled waste batteries has reached 2 tonnes with about 2,700 units of consumer electronic products of any brand recycled and the earnings of a total of NT\$150,000 were donated to the Taipei Orphan Welfare Foundation which is estimated to reduce about 13 tonnes of carbon dioxide emissions.



Circular Production Model

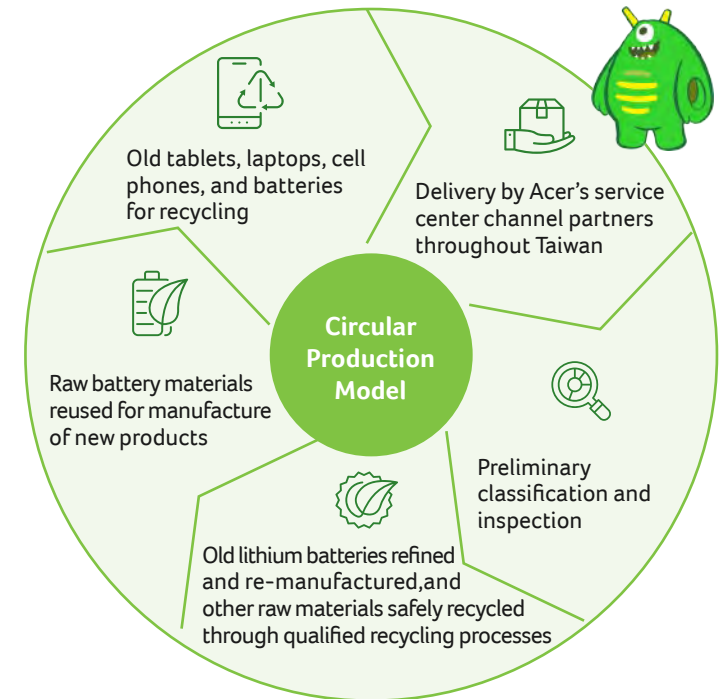



Product Recycling

The Acer Group continues to be committed to working for sustainable lifestyles and a sustainable environment. To this end, we pursue the recycling of limited resources and good mechanisms for recycling waste in hopes of creating new value for our products. We actively support a variety of measures promoting recycling around the world, along with Individual Producer Responsibility (IPR), and are committed to working with stakeholders including governments, consumers, and channels/retailers to shoulder the responsibility for recycling and managing electronic waste. Around the world, Acer follows local government standards for various electronic product recycling programs and provides convenient recycling methods for consumers to improve the efficiency of waste recycling in the hope of contributing to resource sustainability.

In 2022, Acer has recycled a total of 14,012 tonnes of electronic products, with the recycling rate of 14.9% in Asia, Americas and Europe regions.

Recycling Volume for the year 2018-2022

Year	2018	2019	2020	2021	2022
Recycling Volume (Tonnes)	13,318	11,011	11,817	11,227	14,012

Taiwan

We follow the Environmental Protection Administration's announcement on the items that should be recycled and take responsibility for recycling product, including computers and monitors. We also offer 3C recycling services through our service centers located throughout Taiwan, regardless of the brand.

Japan

Acer continues to work with Japan's [PC3R Promotion Association](#) computer recycling organization, enabling consumers to register items for recycling online or by email and then send them in by mail. The Association also organizes for the reuse of any products collected that can still produce cyclical value. In Japan, Acer has set up PC Recycling Centers in hopes of encouraging customers to recycle long-used products and upgrade to newer products still in their usable lives. At the same time, this project also ensures that customers' information security is protected.

Australia

Electronic waste is managed by the National Television and Computer Recycling Scheme (NCRS) under the Australian federal government, which manages the recycling of televisions, computers, printers, computer parts and peripheral products. The objectives of NCRS are to reduce waste that ends up in landfill, increase recycling rates and provide convenient access to recycling services for households and small businesses throughout Australia. Acer collaborates with NCRS-approved Cycle Solutions recyclers to recycle e-waste.



Product Recycling

Europe

Acer adheres to the European Union Waste Electrical and Electronic Equipment (WEEE) Directive with regard to products, also the requirement for batteries, and packaging, aiming to pursue recycling and reduction and providing consumers with information on local recycling channels through their respective national Acer websites.

Pan-America

Acer continued to operate its regulatory and voluntary end-of-life electronics recycling channels in Pan-America to ensure consumers have convenient and environmentally responsible options for recycling their end-of-life products. At the same time, Acer's Tech Trade-up program continued to operate in 2022. The program incentivizes Acer's customers for returning aging devices during IT refresh cycles, to protect the data integrity. Acer also provides value back to its customers or transfers that value into savings for new products. In turn, Acer reuses or properly recycles the old products to extend their life and prevent their valuable resources from entering the waste stream.

Due to the demand for cobalt in the manufacture of lithium-ion batteries and also the child labor associated with the mining of raw cobalt, in 2022, Acer continued to support the recycling of the lithium-ion batteries contained in mobile electronic products via its Call2Recycle license and its own internal process. In addition to the Call2Recycle program support, Acer collected approximately 850 kilograms of spent batteries through its customer service program in 2022 to be recycled through these processes. In 2022, Acer continued its participation in the rule development process for the new producer responsibility recycling program for packaging in Ontario, Canada. Activities in 2022 included setting the fee models in preparation for program launch in 2023. Acer also began preparing for a similar program in New Brunswick which will begin implementation later in 2023.

Acer continued its seat on the Board of Directors for the Washington Materials Management and Financing Authority (WMMFA). The mission of the WMMFA is to provide responsible end of life recycling for the citizens of Washington State in compliance with state law and Department of Ecology direction, and in the most cost-effective manner for our members. The board of directors is comprised of 11 seats and is responsible for managing the business and affairs of the WMMFA as it executes the state recycling plans for its 250+ registered manufacturer members.

Worldwide, Acer Group is working to strengthen the environmental sustainability aspect of social responsibility through responsible recycling models. Acer America continues to require that all recycling schemes ensure appropriate disposal and management of end-of-life electronics devices, components and materials, as well as safeguarding customer data through the implementation of data destruction procedures. Acer America requires that all suppliers and second tier suppliers comply with Acer waste disposal standards for the management of end-of-life products and still has a strict requirement for its recycling vendors to maintain either the Responsible Recycling (R2) or eStewards standards certifications. Acer also continued its recycling vendor auditing program to verify vendor practices and to ensure downstream processors are held accountable as well. For more information on Acer America's recycling program, please visit [Acer America's recycling website](#).

Disclosure of life cycle assessment and product carbon footprint

To make a product sustainable, we must examine its impact on the environment and performance at various stages of development, using this as a basis for enhancing the sustainability of future products. Since 2019, to improve the product competitiveness in commercial bidding and meet customer demand, and at the same time respond to low-carbon trends, Acer has prepared product life cycle assessment reports and carbon footprint reports for representative products and has gradually introduced product carbon footprint calculation and assessment. In 2022, we have completed product carbon footprint report for all commercial notebook products (including Chromebooks) and representative models of desktop and displays products.

Communication and disclosure of product environmental performance

Product Design

At the product design stage, in addition to complying with legal and regulatory requirements for product sales in all regions, Acer continues to improve product energy efficiency, reduce the use of hazardous chemicals, facilitate recycling, and extend product life, all of which indicate our commitment to optimization of product design. Ultimately, we communicate and disclose the environmental performance of our products through a variety of environmental labels. For example, Taiwan has the Green Mark and the Energy Label; China's government procurement requires China Environmental Labeling and China Energy Label; in Europe, Acer uses the TCO Certified to present the product performance on environment.

Product energy efficiency

Acer uses the US ENERGY STAR standard as the basis for product design in energy efficiency and will continue to offer more low energy consumption products to consumers. In 2022, 69% of our notebook, desktop, and monitor products obtained the ENERGY STAR certificate, and we have achieved the midterm goal of reducing the average power consumption of personal computers by 45% by 2025. The average energy consumption of notebook products reduced by 39% and the average energy consumption of desktop computer products reduced by 35% compared with 2016.

Revised Environmental Standards

As environmental labeling standards are revised, Acer continues to track and collaborate with ODMs, evaluating and responding to new standards early to ensure that we have sufficient time to smoothly introduce changes to our products. For example, the revision of EPEAT program includes four modules: Climate Change Mitigation, Sustainable Use of Resources (or Circularity), Reduction of Chemicals of Concern, and Corporate ESG Performance, which will be applied to all EPEAT product categories and starting with Computers and Displays, Imaging Equipment, Mobile Phones, Servers and Televisions.

Chemical substance management

100% of Acer products may contain some chemicals on the IEC 62474 Declarable Substances List due to the use of exemptions from the EU RoHS Directive or Registration, Evaluation, Authorization and Restriction of Chemicals (REACH) regulation candidate list substances when there is no feasible alternative available. We will continue to adopt the principle of early prevention, assessing all potential hazards and chemical substances that may impact the environment with our suppliers to research and develop safer and more suitable substitutes. For more information on chemical management, please visit [Acer's chemical management and plans website](#).

EPEAT and TCO Certified

EPEAT and TCO Certified are currently the most recognized environmental labels. In addition to requirements related to product chemical substances and energy consumption, aspects such as the use of recycled materials, product repairability, extending product life cycle and offering takeback services are mentioned. Moreover, EPEAT and TCO Certified emphasize the social and environmental responsibility of brand manufacturers and their suppliers including labor rights, occupational health and safety, and responsible mineral sourcing. In 2022, 13% of our products are EPEAT registered and 10% are TCO Certified.

Innovative Products and Services

Innovative R&D and Design

Policies/ Commitments

Innovation is one of Acer's core values, and through innovative research and development we create differentiation, establish superiority, and are able to implement full-scale innovation with value.

Stakeholder Engagement and Effectiveness

Predator BiFrost Intel® Arc™ A770 OC graphics card launched by Acer and Intel

Action Plan

- Committing to R&D, patent acquisition, and other core competitiveness, and providing targeted product and service models
- Providing open-source solutions to promote shared social innovation

Tracking Mechanism

- Regular review by Corporate Sustainability Committee's Innovation and Product Life Cycle Team and report to the Corporate Sustainability Committee every six months

Medium- and Long-Term Goals



Customer Center: Listen to customers and keep up with the demands of the market



Solution Orientation: Provide innovative solutions across software, hardware, services, and processes



Diverse Innovation: Combine product features and transformative technologies to achieve greater diversity of innovation



Demand Creation: Incorporate new technologies into products to meet new market requirements

2022 Goals



Provide cooler, quieter cooling management system



Provide more efficient battery management

Status as of 2022



Launch the cooler, quieter BiFrost composite cooling management system



Complete the prototype development and verification of the user behavior optimization battery management

2023 Goals



Mass production verification of user behavior optimized battery management



Development of more stable/durable/ lightweight material

Innovative Design Thinking

Acer's product design is focused around a people-centric spirit and approach which asks the following fundamental questions:

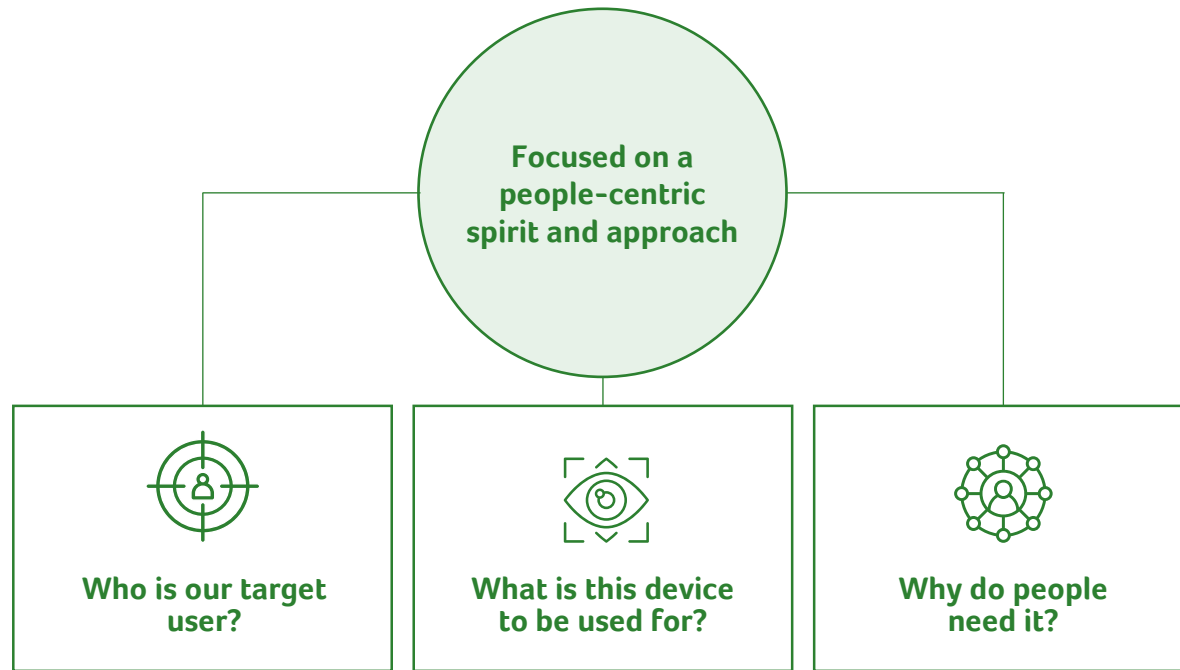

We are dedicated to understanding the needs and behaviors of users and are eager to solving human problems through technology. At the same time, though, we must bear in mind both technological and commercial feasibility. Acer's innovative R&D process is built around learning through testing and cooperation across fields which brings together outstanding talent with backgrounds in products, UI, graphic design, and engineering to maximize the value of Acer's products and bring users the best possible experience from concept development and prototyping through to final testing.

Continuous innovation is a core value for Acer, as through it, we can gain a competitive edge. Our patent strategy is to invest resources in continuous innovative R&D, building a patent network and demonstrate the benefits of our patents while also establishing a set of strict patent measures to protect our R&D achievements.

Acer's Patent Protection Measures

- **Regular patent education and training**

General staff have specialist knowledge in their own fields, but to ensure that all have a basic knowledge and understanding of intellectual property rights, Acer regularly holds internal training on patent-related issues.

- **Occasional patent seminars**

In response to changes in patent laws and regulations or the influence of litigation practices of major foreign companies, Acer occasionally holds patent seminars and invites professional foreign patent attorneys and industry professionals to share the international trends.

- **Establish an ePatent system to manage patent case information electronically**

Acer is equipped with an ePatent system to manage all of our patents electronically. In addition to allowing all patent cases to be filed through it, the ePatent system can also be used to check basic information regarding patent cases and stay on top of patent status.

- **Electronically-managed R&D logs**

Having dealt with the challenges of managing, preserving, and querying paper-based R&D logs, Acer has established an eBook system as a replacement. Each member of the R&D team can set up their own log by logging into the system, with subsequent management, preservation, and querying a much simpler matter.

- **Encourage employees to innovate and create**

To encourage employees to engage in inventive and creative work, Acer has established the Invention Incentive Scheme. In addition to a general patent application bonus and approval bonus, specific awards include an annual patent excellence bonus.

- **Establish a patent evaluation process to control patent quality**

Patent engineers conduct technology analysis to filter out proposals that meet the novelty and inventive patent requirements with high innovation and high product application value and the country of the patent application will be determined through the patent evaluation meeting.

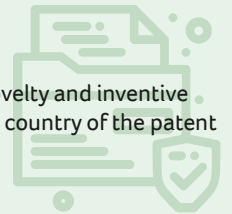

Benefits of Patent Strategy

- **Encouraging innovation**

The use of patent awards, medals, and certificates encourages employees to engage in invention and creativity.

- **Demonstration of technical drive**

Technology R&D is the main driving force for the survival and growth of our business, and that R&D must be linked with demonstrations of technical drive through patent applications.

- **Product competitiveness**

Only with the protection of patent rights can we gain a secure edge in the market and keep our products competitive.

- **Exclusion of competition**

The only way to obtain legal exclusivity of technology is to apply for a patent, which prevents competition from counterfeits and facilitates an exclusive market share.

- **Legal defense**

Acer's patent strategy is primarily defensive in nature. Different types of patent portfolios can increase negotiation leverage and reduce the risk of patent litigation.

- **Increasing patent bargaining power**

After accumulating certain degree of patent strength, we are thus in possession of more favorable bargaining chips upon entering patent negotiations.

- **Income from royalties and disposition**

If a patent is licensed or transferred to another entity, royalties or patent transfer fees may be received, creating real economic benefits for the Company.

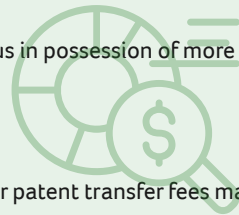

To safeguard the R&D and innovation result, Acer continues to implement global patent strategies. As of the end of December 2022, it has obtained 7,656 issued patent certifications in various countries, including at least 3,400 issued by Taiwan and at least 1,300 issued by the United States. Acer's domestic patent applications and issued patents in Taiwan have remained among the top five domestic legal entities for four consecutive years.

Acer Group announced to join the RE100 initiative in 2021, committing to use 100% renewable energy by 2035, and is actively expanding its lineup of eco-friendly Vero products. All Acer products use a certain proportion of post-consumer recycled plastics (PCR), ocean bound plastics (OBP) and recyclable packaging, etc., with high maintainability and advantages in rapid disassembly, maintenance, upgrading and recycling, providing consumers, businesses and organizations with options to reduce their carbon footprint.

In addition to the eco-friendly Vero product line, Acer launched the eKinect BD 3 Bike Desk, which allows users to pedal a bicycle as exercise during work while generating clean electricity to charge work devices.

MPS, a subsidiary of Acer, announced that it has joined hands with the international bicycle manufacturer IDEAL and LED manufacturer Ligitek to jointly develop the sharing E-Bike platform adopted by many service operators in European countries, and launch the E-Bike subscription service to the market. Acer has filed relevant patent applications for the above products.

Approved Patents in 2022

Region	Patents Obtained in 2022	Patents Obtained in 2021	Growth Over 2021
Taiwan ^{Note}	414	411	0.7% ↑
Pan-European (including UK)	73	56	30.4% ↑
Pan America	151	150	0.7% ↑
China	166	192	13.5% ↓
Total	804	809	0.6% ↓

Note: The 414 approved patents in Taiwan include 23 joint patents with other companies, of which 11 joint patents are not first applied by Acer.

Important Innovative Technology in 2022

BiFrost composite cooling management system

The cooler and quieter BiFrost composite cooling management system is designed for desktop computers where special dual fan configuration allows most of the air to be exhausted and only part of the hot air remains inside. Coupled with the Vapor Chamber design, it can effectively reduce the internal temperature of the computer through its extremely high temperature uniformity and conductivity. Compared with the dual-axial fan design, the intake air temperature of the graphics card can be reduced by up to 7 degrees.

Regular design

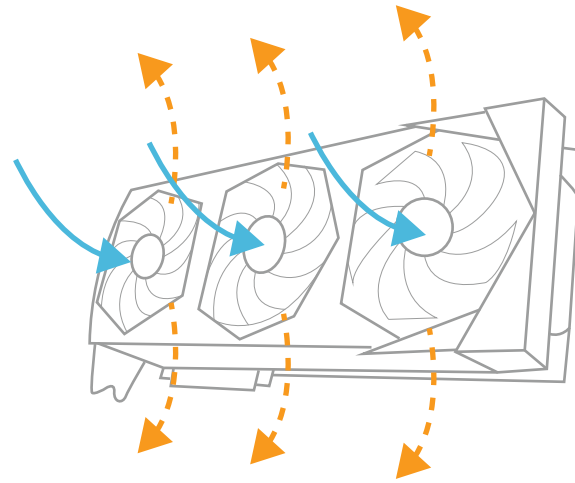

acer

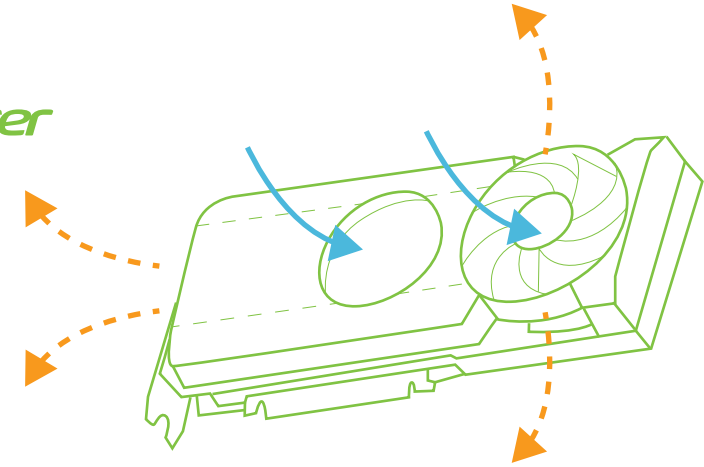

This design is combined with the 5th generation Acer AeroBlade 3D metal fan that was only available in Acer notebooks which is 87.5% thinner than normal generic plastic fans and can increase the airflow during rotation, and with axial FrostBlade™ 2.0 technology to keep the system cool and ventilated at any time; it utilizes a static pressure design to optimize airflow while reducing vibration and noise and speeding up the cooling via a new arc-shaped design along the ends of the fins. This design is applied to the Predator BiFrost Intel® Arc™ A770 OC graphics card launched by Acer and Intel in 2022.

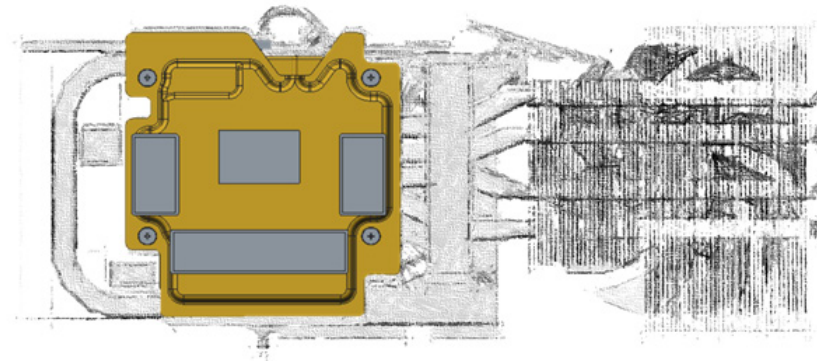

Vapor Chamber Design

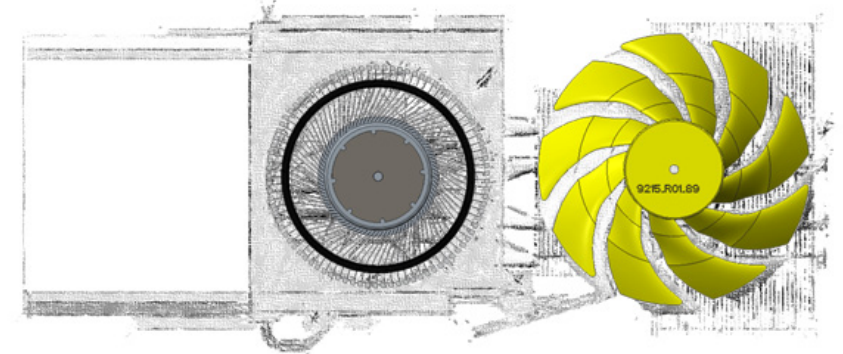

Acer AeroBlade 3D metal fan in the middle, FrostBlade™ 2.0 fan on the right



Optimize charging according to user behavior

According to different user behavior, the notebook batteries are categorized in different working environments (voltage during storage, temperature during operation, current during charge and discharge, etc.), which indirectly causes different degrees of battery aging, and affects the battery life.

For users who always keep the notebook adapter plugged in, the desktop-like usage will cause the battery to be stored in a high voltage state for a long time, which will accelerate the aging of the battery and reduce the battery life.

For users maintaining a regular habit of using computers for daily life and work, there will also be a certain behavioral pattern. For instance, a fixed behavioral pattern may involve shutting down and charging the computer at 11 PM, and then turning it on for use at 7 AM in the morning. Acer's battery management system will optimize the charging algorithm for different user behavior patterns, thereby delaying battery aging and increasing battery life.

Enable Battery Adaptive Charging setting through the built-in Acer Care Center, the battery health will increase by more than 25% after charging and discharging 500 cycles.

Acer has completed the development and verification of the prototypes in 2022 and will select the models for mass production with evaluation and confirmation.



Acer SpatialLabs technology delivers an intuitive interaction and immersive stereoscopic 3D.

In the time where physical and virtual reality are increasingly integrated, Acer's [SpatialLabs™](#) technology presents an excellent medium. This technology allows users to watch immersive stereoscopic 3D model imaging without wearing glasses, bring the virtual world to the reality and providing users with the latest and most intuitive stereoscopic 3D experience.

Acer and LightMatrix Inc. combine the most advanced optical technology, display, AI and real-time rendering technology to integrate digital 3D models of artifacts in the National Palace Museum's special exhibition "Curio cabinets and the Collection, Storage, and Display of Artifacts" for a new 3D interactive experience. Acer and LightMatrix Inc. broke through the limitation of the glass display, allowing visitors to easily view high-precision 3D digital models without wearing special glasses. Through UHD 4K screen and the interactive mode of gesture tracking, stereoscopic 3D images are clear and vivid, and artifacts seem to pop out of the screen. Viewers can operate and interact with artifacts more intuitively, take out artifacts from Curio cabinets, rotate and adjust the angle of the artifacts in 360 degrees, savor the historical traces and details, with the innovative, immersive, and interactive experience.

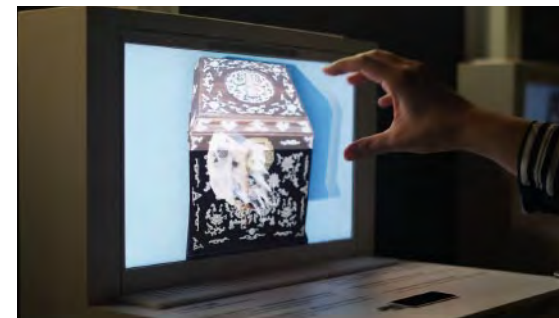

Innovations for the Environment and Society: Smart City and Eco-friendly Lifestyle

Acer complies with the UN's Global Goals for Sustainable Development, continues to develop several software and hardware application technologies and products, and commits to sustainability with innovative and environmentally friendly technologies and applications.

Acer outlines the new look of smart cities where subsidiaries provide innovative solutions in various fields for daily life, such as: smart roadside parking management system, smart transportation solutions, smart city and industry 4.0 solutions through commercial Internet of Things, smart medical for remote and AI-assisted diagnosis software or green energy mobile.

Smart Cities and Eco-friendly Lifestyle

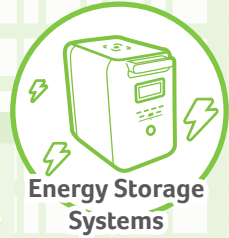

Energy Storage Systems



Smart Air Quality Monitors



Vero Products Made with Recycled Materials



Service & Repair



AI-Assisted Medical Diagnostic Software



Air Purifiers



Bike Desks with Kinetic Energy Conversion

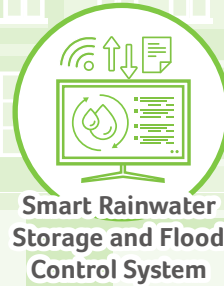

Smart Rainwater Storage and Flood Control System



Smart Parking & EV-Charging Stations



Medical System
(Computers, Displays, Accessories)

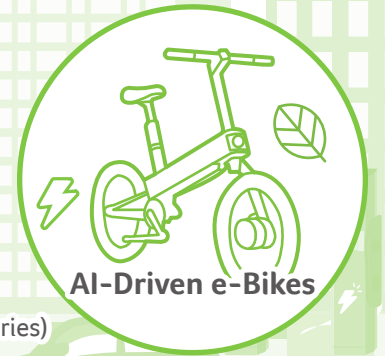

AI-Driven e-Bikes

Smart Parking



- Smart parking solution helps drivers to find roadside parking spaces easily, and integrates payment and EV charging features



Smart Medical



- AI-assisted software speeds up the diagnosis of patients with diabetic retinopathy
- Facial recognition systems predict mood changes in people with dementia

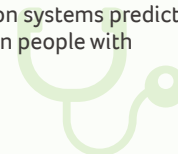

Healthy Living



- Air purifiers with air quality sensors detect suspended particles and filter out harmful substances to improve air quality
- Ozone antibacterial sanitizer produces ozonated water for cleaning items.
- Systems designed for the medical environment with features such as being waterproof, dustproof, antimicrobial coated, and more

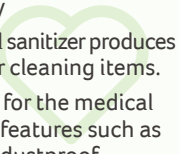

Green Energy Application



- The bike desk converts kinetic energy generated by users' pedaling into electricity
- E-scooters offer eco-friendly travel options
- AI-driven e-bike adapts to riding conditions and preferences for the optimal riding experience
- Mobile power systems

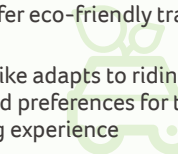

Circular Economy



- Vero devices are built with recycled materials like post-consumer recycled (PCR) plastic
- Service and repair for multi-brand products



Smart Water Usage



- The rainwater storage and flood control system has the function of regulating rainwater flow
- Smart water meters attached on traditional meters process the reading and transmit data to the water company





Acer Vero Products Made with Recycled Materials



In 2021, Acer launched the first eco-friendly laptop Aspire Vero. From 2022, Acer expanded the Vero concept on sustainable design to more product lines and models, reducing energy consumption and pollution generated in the development of new products. At present, there are a variety of laptops and monitors, as well as all-in-one desktop computers, projectors, and peripheral accessories, all of which adopted the Vero concept. They use paint-free chassis, environmentally friendly recycled materials and packaging to reduce carbon emissions and pollution. Vero products have also obtained international certifications such as TCO, EPEAT or the US ENERGY STAR label.



Acer Facial recognition systems predict mood changes in people with dementia



Acer and Acer Medical developed a face recognition system that uses facial emotions to determine possible dementia. The R&D team and physicians use the Neuropsychiatric Inventory (NPI) as a standard, establish a prediction model based on AI algorithms, and complete the Acer NPI Auxiliary System, which integrates 4 AI algorithms including face recognition, mask recognition, emotion recognition and NPI. Traditionally, professionals have relied on neuropsychological assessment and NPI to determine dementia symptoms, and the assessment results may vary due to personnel experience or patients' expressive ability. Through the long-term and systematic collection of facial expression data provided by the solution and the prediction model established by AI, real-time NPI scores can be obtained for each recognition, eliminating differences in human evaluation, and enabling prompt intervention for early detection of abnormal emotions. As of the end of 2022, this system has been successfully introduced into 22 nursing institutions in Taiwan. In addition to reducing the burden on medical staff, it can intervene immediately when symptoms occur, delaying the rapid decline of body functions, and helping to prolong the health of elders.



Figure Introduction of Acer NPI neuropsychiatric assessment scale auxiliary system



AOpen Medical Antibacterial System (Computer/Monitor/Keyboard & Mouse)



With the raised health awareness of epidemic prevention in Taiwan, the use of antibacterial equipment is no longer limited to medical institutions. AOpen has launched a full range of antibacterial medical computers/monitors and washable keyboards/mouses. The equipment is made of silver ion antibacterial material, which has passed the EN/UL 60601-1 International Product Safety Standards for Medical Devices. It effectively reduces and inhibits the growth of bacteria, and can prevent Staphylococcus aureus, Escherichia coli and other bacteria from growing.

The keyboard and mouse can also be cleaned with common detergents for optimal disinfection to protect the health of the next user.



Acer Medical AI-Assisted Medical Diagnostic Software



Acer Medical's smart medical device VeriSee DR (AI detection of diabetic retinopathy) was launched in September 2020 and has been introduced to more than 150 medical institutions at all levels in Taiwan and overseas to assist hospitals to increase the screening rate of diabetic retinopathy and improve the quality of eye care for people with diabetes. VeriSee DR has been adopted by nearly 80% of medical centers and medical institutions at all levels in Taiwan. At present, it is estimated that more than 350,000 diabetic patients in Taiwan can enjoy the non-mydratic AI fundus examination service every year. That is, about 1 out of every 3 diabetics who have regular diabetes screenings uses AI fundus screening. Through AI analysis and symptom annotation, VeriSee DR can assist healthcare providers in the care of diabetes patients to speed up the diagnosis time of diabetic retinopathy, improve the detection accuracy, and effectively direct high-risk eye disease patients to ophthalmologist for follow up and treatment. Through AI detection software, healthcare providers in diabetes care deliver higher-quality services, and at the same time allow ophthalmologists to focus more on treating high-risk eye disease patients.





Highpoint Service Network Corporation Service and repair for multi-brand products



HSN provides multi-brand inspection with multi-country support and the authorization of original manufacturer. HSN provides after-sales service for consumer electronics, including computers, smartphones, workstations, and appliances. HSN has been authorized by more than 30 international brands to provide consumer inspection, repair, maintenance, and upgrade services.

HSN provides a full range of services based on customer demands, from pre-purchase consultation, product function setting, warranty, maintenance, to product recycling at the end of the service life. HSN provides services in every step of the product life cycle, reduce the burden on enterprises and consumers, and improve product performance and reduce environmental impact.



Acer Gadget Bike Desks with Kinetic Energy Conversion



The Acer eKinekt BD 3 combines a stationary bike and a desk, allowing users to exercise while working. The bike desk's energy generated by pedaling is converted into electricity to power the machine and charge personal devices. When the pedals are in rotation, kinetic energy can be converted into electricity where pedaling at 60 RPM for one hour can generate about 75 watts of electricity. The bike desk can charge laptops and other devices, while accomplishing both work and exercise. The desk surface and outer case are made from post-consumer recycled plastic (PCR) to demonstrate our long-term commitment to finding a balance between innovative solutions and a sustainable environment.

Acer eKinekt BD 3 is equipped with USB Type-A and USB Type-C ports, which can charge multiple mobile devices at the same time, and it comes with a bag hook and beverage holder. Users can easily adjust the desk surface position of eKinekt and switch between work or sports mode. The exclusive mobile app that comes with the Acer eKinekt BD 3 can track user exercise history over a certain period, displaying information such as riding time, calories consumed, and power generation.



Acer Gadget AI-Driven e-Bikes



Acer ebii is an electric bicycle with AI technology at the core to meet the diverse demand of cyclists through the smart ebii Box. It utilizes ebiiAssist technology to automatically adapt to route conditions, pedaling power and user preferences, providing users with a relaxed and pleasant ride and an uninterrupted journey. Acer ebii is equipped with long-lasting battery life, smart security, and anti-theft capabilities with a streamlined and lightweight design, allowing users to roam the city streets with style, comfort, and convenience.

With our innovative technology and creative design, the Acer ebii electric bicycle implements Acer's commitment to corporate sustainability, demonstrates excellence in sustainable development and user experience, and provides urban commuters with convenient, safe and environmentally friendly mobility options.



Mobile Power System Inc. Mobile Power Systems



The battery module is designed with an advanced structure and a battery safety management system to meet various high-impact applications. The Acer controller integrates batteries and motors with software, hardware and IoT technologies to power the e-bike power system with efficient batteries and motors performance.

Currently, there are numerous global e-bike and shared e-bike manufacturers using the battery modules and power systems developed by Acer Mobile Power System Inc.

Acer Mobile Power System Inc. provides affordable, safe, environmentally friendly, and robust transportation equipment to realize our concept of sustainable city.

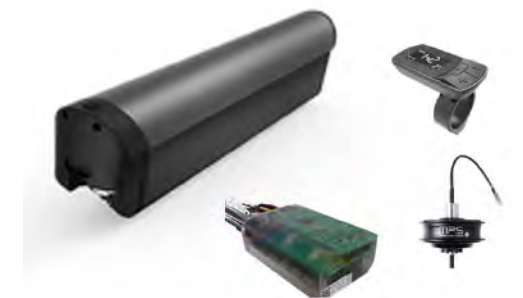



**Acer ITS INC
Smart parking solution**



Acer ITS INC. has successfully deployed more than 6,500 smart parking spaces with Smart parking solution in Taipei, New Taipei, Miaoli, Tainan, Kaohsiung, Pingtung, and other cities. This solution combines vehicle detection, license plate recognition, smart ticketing, and diversified payment capabilities, providing users with automated, intelligent, and efficient smart parking and management services through the front and back-end of the system. Compared with traditional paper-based ticketing, this system recognizes license plates, accurately calculates rates, transmits and analyzes big data, reduces manpower and paper consumption, and helps government agencies to improve parking management efficiency. Drivers can use the parking app to instantly query the parking spot information via Internet, reducing traffic congestion and air pollution as resulted by detours, and improving the turnover rate of parking spaces. Users can conveniently use electronic tickets or app to automatically pay parking fees for a non-induction payment.

In addition, as a leading manufacturer of smart roadside parking system, ACER ITS INC. planned and integrated the rigid demands of electric vehicles: parking and charging, and launched smart parking and charging piles before the rise of the electric vehicle; taking advantage of the diverse payment options, the innovative "diverse payment options without signing up" is the first to be created. Payment with electronic tickets can be used on the go, which mitigate the requirements for car owners to download and bind different apps to use charging services. Automatic bill payment through parking lot app membership allows users to make payment as they go.



Figure Demonstration of smart parking management system



**Acer Being Communication
Smart Rainfall and Flood Control
Water Storage System**



Water is one of the most important environmental issues in the world. In the process of urbanization, buildings turn the water retention soil into reinforced concrete that cannot absorb water, not allowing the rainwater to be converted and stored as groundwater. It increases the load on the underground waterway, which increases the probability of urban flooding. In addition, with the increase in population, the daily water consumption has been greatly increased, and the widespread water supply pipelines have also hidden problems of water leakage and water quality. To combat this issue, Acer Being Communication released the "Smart Rainfall and Flood Control Water Storage System" which utilizes the raft foundation of urban buildings for runoff to achieve urban flood control. The system provides flood control and flood detention where cloud commands are issued based on weather forecasts, real-time rainfall, and the water level of nearby rainwater sewers to automatically control valves and pumps to achieve resilient urban water storage and drought prevention, drainage, and flood detention.

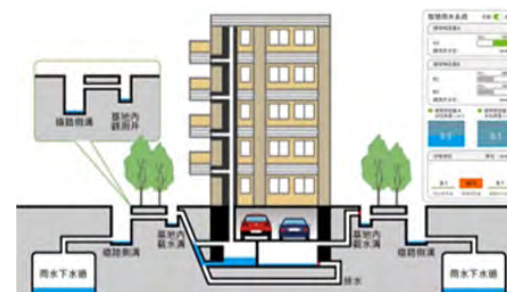

**Smart Frequency
Energy storage system**



With the latest technology with safe and stable lithium-iron batteries, Smart Frequency has developed a series of small household energy storage products with elegant design, safety and reliability. In addition to the uninterruptible power system (UPS), the use of the products ranges from home emergency backup power, outdoor power supply, outdoor photography to picnics. It can be a small power supply center for various equipment (1kWh, 2kWh, Max. 3kWh), without the unpleasant smell and noise of traditional generators and can be charged with solar panels to provide reliable, clean, green and environmentally friendly backup power.



Acerpure Acer Air Monitor Pro



Acer's air quality improvement solution is a collaboration between Acer and its subsidiary Acerpure. As the detector detecting various air quality indicators (PM2.5, PM10, CO, O3, TVOC, etc.), it displays the air quality information on the panel which is supported by multiple devices (Computer, mobile phone, tablet), so the users can view the indoor air quality in real time. With the pollution issues solved, we collaborated with several air purifier manufacturers to develop air purifier and improve the air quality. The collected data is used for one-stop platform data management and data analysis through the AI prediction module and cloud communication technology.

This one-stop platform provides solutions for software, hardware and services from detection, display, improvement to monitoring indoor air quality. Since 2019, it has been deployed in more than 4,000 sites such as campuses, commercial sites, and hospitals, providing users with a healthy breathing environment. It also provided opportunities for day care centers to obtain the world's first International WELL Building Certification in 2022. Real-time monitoring and improvement of indoor air quality can reduce human health hazards caused by air pollution, and solutions across various sites can help to build a sustainable city and environment with good air quality.



Figure Demonstration of Acer's air quality improvement solutions

Acerpure Air Purifiers



Acerpure is a subsidiary of Acer, focusing on the R&D of high-efficiency and intelligent clean home appliances. The primary product is the 2-in-1 air circulator and purifier that combines air purifier and circulation capabilities which filters polluted air through intelligent sensing and higher grade HEPA filters, delivers clean air to all corners of the house, reduces the chance of virus spreading indoors, ensures the clean environment and health of users, and realizes smart home through remote control app. In addition to the 2-in-1 Acerpure Cool, Acerpure has developed a high-efficiency air purifier that combines CO₂ detection with disinfection UVC light and will launch a water purifier and cordless vacuum product line in 2022, providing a full range of purified life in air quality, drinking water and home cleanliness.

Numerous products of Acerpure have won international awards, including iF Design Award, Good Design and Taiwan Excellence Award. They have been recognized for their outstanding performance in product design, quality and energy-saving certification and they are available in the global markets such as Japan, Malaysia, the Philippines, Thailand, France, and Switzerland.



Keypack Technology Corporation Limited Manufacturing of lithium battery module



Keypack Technology provides global customers with lithium battery manufacturing design and manufacturing services with advanced and creativity and provides mass-produced and cost-optimized manufacturing suggestions for new applications. The manufactured lithium battery modules are used in electric bicycles, electric vehicles, energy storage, and other fields.

By expanding the application of lithium batteries, Keypack Technology fulfills its commitment to Acer's corporate sustainability by reducing fossil fuel emissions, mitigating the impact of climate change, and providing reliable and modern energy.





06

CLIMATE STRATEGY AND TRANSFORMATION

While climate issues have driven the transformation of the global low-carbon economy and business models, Acer shoulders the mission of being a leader and promises to achieve net zero emissions by 2050 and increase the share of renewables in energy consumption to 100% by 2035. It also looks to integrate existing and new business groups to formulate low-carbon sustainable business strategies, create ESG value and ultimately improve corporate competitiveness.

- **Blueprint for Low-carbon Transition and Climate Strategy** 106
- **Climate Risks and Opportunities and Climate-Related Financial Disclosures (TCFD)** 108
- **Greenhouse Gas (GHG) Emissions** 111
- **Our Climate Actions** 114

 Net Zero Commitment	<h1>100%</h1> Joined the RE100 Initiative	<h1>A-</h1> CDP Leadership (A-)
--	--	------------------------------------

Energy, Carbon Emissions and Climate Action

Indicators related to GRI/SASB
GRI 305-1~7, GRI 201-2, GRI 302

Policies/ Commitments

- Net zero emissions by 2050
- 100% renewables electricity usage by 2035
- Introduce the Recommended Framework for Task Force on Climate-Related Financial Disclosures (TCFD)
- Set Science-Based carbon reduction targets (SBT)

Stakeholder Engagement and Effectiveness

- Joined CDP and Taiwan Climate Partnership to promote the low-carbon transformation of the industrial chain
- Joined RE100 to promote a friendly renewable energy development environment
- Launched the Earthion initiative to bring partners and suppliers together to maximize positive impact on the environment
- Launched Earthion Mission: 21-Day Challenge to take carbon reduction action with employees and partners

Action Plan

Outlining 9 directions under 3 major pillars of business operation, product and service, and value chain, implement energy consumption reduction plan and use of renewable energy at the operation, and conduct carbon negative research; continue to improve product energy efficiency and the usage of recycled materials for product, and launch a number of smart and green energy products; accelerate the supply chain development on green design and innovative process through continuous advocacy and collaboration to strengthen green manufacturing and logistics, and achieve low-carbon circular economy.

Tracking Mechanism

- Report climate-related issues to the Risk Committee or Corporate Sustainability Committee every quarter, and report to the Audit Committee/Board of Directors
- Establish internal energy and carbon emission management indicators, and review the implementation performance with ISO 50001 Energy Management System and ISO 14064 Greenhouse Gas Inventory and Verification

Medium-Term and Long-Term Goals



Net zero emissions by 2050

100%

100% renewable electricity usage by 2035

50%

In 2030, operation carbon emissions (Scope 1, 2) will be reduced by 50% compared to the base year of 2019; value chain carbon emissions (Scope 3) will be reduced by 35% compared to the base year of 2020 (in line with the SBT aligned with the 1.5°C carbon reduction pathway)

2022 Goals

45%

45% of electricity consumed from renewable sources

12.6%

12.6% Scope 1, 2 carbon emission reduction compared with the base year of 2019



Formulate Scope 3 carbon emission reduction targets

2022 Achievement Status

44%

44% of electricity consumed from renewable sources (not achieved)

16.5%

16.5% Scope 1, 2 carbon emission reduction compared with the base year of 2019 (achieved)

35%

Formulate Scope 3 carbon emissions reduction target of 35% in 2030 compared to the base year of 2020 (achieved)

2023 Goals

45%

45% of electricity consumed from renewable sources

16.8%

16.8% Scope 1, 2 carbon emission reduction compared with the base year of 2019

7.5%

7.5% Scope 3 carbon emission reduction compared with the base year of 2020

Blueprint for low-carbon transition and climate strategy

While climate issues have driven the transformation of the global low-carbon economy and business models, Acer shoulders the mission of being a leader and promises to achieve net zero emissions by 2050 and increase the share of renewables in energy consumption to 100% by 2035. It also looks to integrate existing and new business groups to formulate low-carbon sustainable business strategies, create ESG value and ultimately improve corporate competitiveness.

To achieve the net zero carbon emission by 2050, Acer has announced the key strategies including 9 directions under 3 major pillars. We are committed to reducing carbon footprint and emissions with 3 dimensions of business operation, product and service, and value chain.

In business operations, Acer has introduced the Task Force on Climate-Related Financial Disclosures (TCFD) and the internal carbon pricing mechanism to monitor climate risks and opportunities fully and effectively.

In response to the Science Based Targets (SBT) aligned with the 1.5°C carbon reduction pathway, we are committed to achieve a 50% carbon reduction in operations (Scope 1+2) by 2030 compared to 2019, and implement a number of carbon reduction and renewable energy actions to reduce operating carbon emissions. In addition, we conduct carbon-negative research, including carbon credit development, and carbon capture and utilization (CCU).

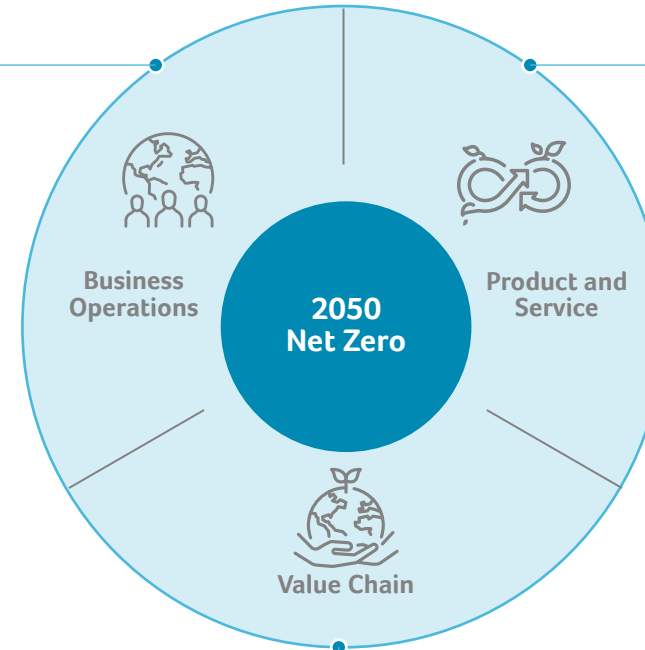

In product and service, Acer incorporates the circular economy concept and considers the product life cycle in R&D and design to reduce the environmental impact and balance product management and environmental performance. Acer has introduced the carbon footprint tool, completed the carbon footprint report of all commercial PC products (including Chrome book) and representative desktop PC and monitor products, and developed Modern Standby power management mode. Acer also launched the environmentally friendly Vero product line. It all begins with raw materials as we continue to increase the use of sustainable materials such as post-consumer recycled plastics (PCR) and ocean-bound plastic (OBP) to reduce the material carbon footprint. Acer promotes the reuse of resources and establishes a circular economy.

In the value chain, since "Project Humanity" in 2017, Acer has been implementing environmentally friendly actions and laying the foundation for a net zero carbon emission strategy with global employees for a low-carbon supply chain. In 2021, we launched the "Earthion" project to promote carbon reduction action to like-minded suppliers and work closely with suppliers and partners in projects such as energy, product design, packaging design, manufacturing, logistics and recycling to reduce the plastic materials used in the production process. We join hands with the suppliers to execute low-carbon transformation where collaboration can bring a positive impact on the environment and create a cleaner and more sustainable future life.

Acer's Net Zero Emissions Strategy

Operations

Minimize Energy consumption

Set energy-saving targets, use high-energy efficient equipment, choose electrification, and low (or carbon neutral) fuels

Use Renewable Energy

Install renewable-energy generation facilities, sign power purchase agreement (PPA), purchase renewable energy certificates



Carbon Removal and Offsets

Purchase and develop carbon credit, research on carbon capture, utilization, and storage (CCUS)

Products and Services

Low-Carbon Products and Services

Boost product energy efficiency, reduce the carbon footprint of products and services



Choose Sustainable Materials

Use post-consumer recycled (PCR) plastics and ocean-bound plastics (OBP) in products

Smart, Circular and Renewable Applications

AI, IoT, circular, renewable energy storage and creation

Value Chain

Commit to Carbon Reduction Targets

CDP, science-based targets (SBTi), RE100

Green Manufacturing and Logistics

Save energy, use low (or carbon neutral) fuels, optimize processes

Earthion Missions



Realize a Low Carbon and Circular Economy

Material circularity, DaaS (device as service) business



Acer's Milestone in Response to Climate Change

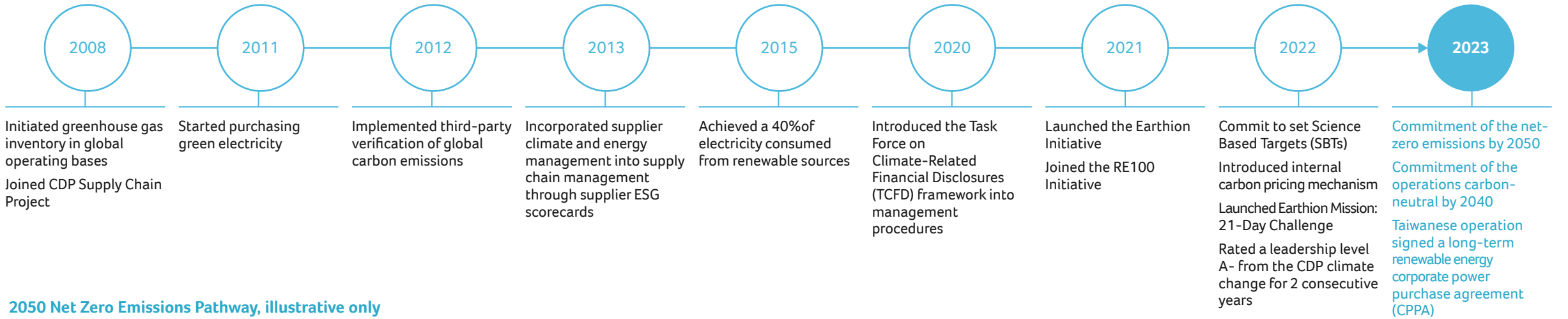

2050 Net Zero Emissions Pathway, illustrative only

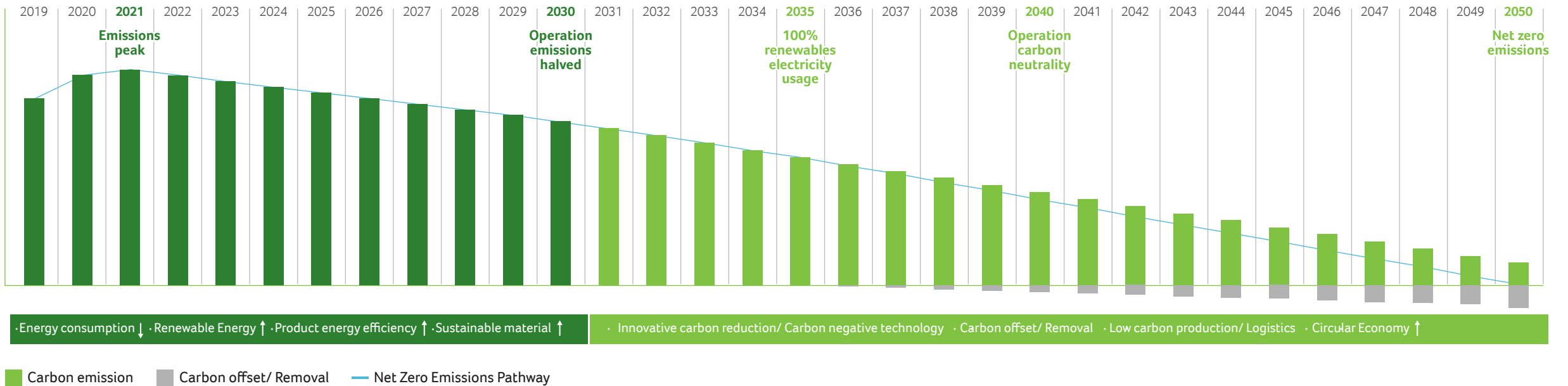



Climate Risks and Opportunities and Climate-Related Financial Disclosures (TCFD)

In 2020, Acer has officially implemented the Recommendations of the Task Force on Climate-related Financial Disclosures issued by the Financial Stability Board of the United Nations to analyze the current status of climate-change-related financial disclosures, identify and quantify climate risks, and publicly disclose the potential financial impact of climate change on Acer and its future response strategies.

In 2022, Acer optimized the TCFD management procedures and integrated climate change-related risks into Acer's risk management policies and risk management operating procedures. The Risk Management Committee will approve/declare the environmental risk, risk management priorities, assessment results and related responses measures and report to the Audit Committee and the Board of Directors at least once a year. This section focuses on and describes the core elements of the TCFD's disclosure recommendations, which are divided into governance, strategy, risk management, and metrics and targets. For detail, please see our CDP Climate Change Questionnaire, or our TCFD report which is expected to be released in the third quarter of 2023.

The Board of Directors/Audit Committee are the highest authorities responsible for the Company's risk management which promotes and implements the Company's overall risk management policy in accordance with the overall operating strategy and business environment to ensure effective risk management.

The Risk Management Committee under Acer's Board of Directors/Audit Committee approves/declares the environmental risk, risk management priorities, assessment results and related response measures, and supervises the continuous improvement of risk management and performance. The management committee is composed of the top executives of each business unit/functional organization at the headquarters with the top of the auditing department as an observer to supervisor, managing risks including strategic risk, operational risk, financial risk, disaster risk, and climate change, and reporting to the Audit Committee and Board of Directors at least once a year.

For the implementation, the risk management team of the Risk Management Committee is the unit responsible for introducing the TCFD climate risk assessment framework and to conduct climate risk identification, climate scenario and operational impact assessment, formulate climate risk prevention and mitigation measures based on the assessment and report to the Risk Management Committee.

Acer incorporates climate risk identification and assessment into the enterprise risk management (ERM) process, through the three lines of defense of the risk management organization, self-assessment and process improvement of each business unit, procedural guidance and legal compliance of each support department, and the audit management procedures of internal audit unit. We integrate the ERM implementation with the daily operating procedures of each department/unit and the Company's business targets, and integrate the ESG and climate factors into the decision-making process. Through the PDCA cycle, we conduct regular reviews on the effectiveness of the risk management plan and the improvement possibility during the working group meeting for continuous adjustment/improvement

Acer's risk management team takes the potential impact of climate change into overall operational considerations, evaluates the probability of risk occurrence and impact, and formulates climate risk prevention and mitigation measures. For climate change scenarios, Acer referred to relevant international carbon management trends, TCFD recommendations, and reports and information released by other relevant domestic and global institutions and introduced physical and transition risk scenarios such as RCP 2.6, RCP 8.5, IEA NZE 2050, and NDCs (Taiwan). Acer identified short-, medium- and long-term climate change risks with considerations in its business characteristics and evaluated the potential impact of each business unit when transition risks and physical risks occur based on the concept of materiality.

When it comes to opportunities brought about by climate change, Acer held climate-related identification workshops and distributed climate risk prioritization by materiality surveys for relevant units' assessment and identified developing and/or increasing low-carbon goods and services. With R&D and innovation, Acer can develop new products and services and other related opportunities, and continuously improve the product energy efficiency, build solar power stations to increase the share of renewables electricity usage, provide professional knowledge and experience in the ICT industry, and ensure the society and various departments of Acer can achieve the energy conservation and carbon reduction goals or carry out corresponding transformation and adjustment methods to expand the Group's business and implement the daily management of climate issues.

Acer shoulders the mission of being a leading brand and promises to achieve net zero emissions by 2050, increase the share of renewables in energy consumption to 100% by 2035 and set Science Based Targets (SBT) aligned with the 1.5°C carbon reduction pathway. By 2030, Acer aims to reduce carbon emissions by 50% in organizational operations compared to 2019, and reduce the value chain emissions by 35% compared to 2020. In addition, by 2025, the Acer personal computer product average energy consumption will be reduced by 45% compared to 2016 and the computer and displays product will reach to 20-30% post-consumer recycled plastic material content.

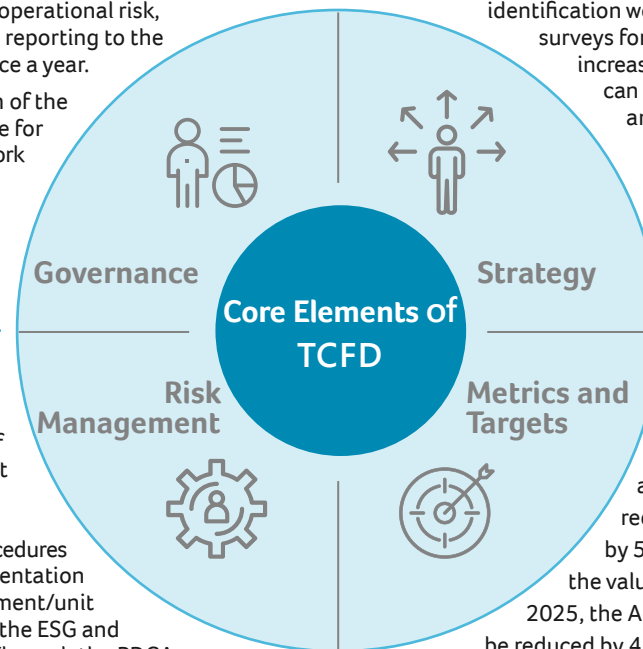

Greenhouse Gas Emissions

Since 2011, we have conducted annual GHG inventories in accordance with the GHG Protocol and in line with the Group's consolidated financial reporting boundaries. We also commissioned a third-party verification agency certified by Taiwan's Environmental Protection Administration to undertake greenhouse gas emission verification for both direct and indirect categories, i.e., Scope 1, Scope 2, and Scope 3, and acquired the ISO 14064-1: 2018 Greenhouse Gas Verification Statement.

In 2022, the verified carbon emissions from operation (Scope 1, 2) were 11,490 tonnes, a reduction of 16.5% from the base year of 2019, meeting the expected reduction target. Among them, Scope 1 emissions were 2,705 tonnes, a decrease of 23.6% compared with the base year of 2019, resulted by the reduction in the use of natural gas, reduced travel emissions with virtual conferences, and the electrification of gasoline and diesel vehicles and other carbon reduction actions. Scope 2 emissions were 8,784 tonnes (market-based), an increase of 0.4% compared to the previous year and a decrease of 14% compared to the base year of 2019, resulted by the reduction of energy consumption coupled with renewable energy usage.

Operational carbon intensity (carbon emissions per unit of revenue) was 41.7, a decrease of 29% from 2019; per capita emissions were 1.49 tonnes, a decrease of about 14% from 2019.

Acer Group Annual Greenhouse Gas Emissions
(Unit: CO₂eTonnes)

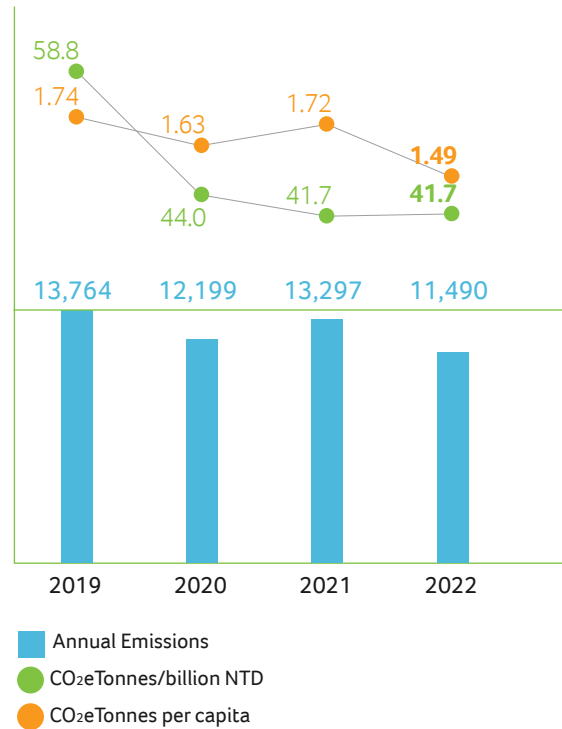

For Scope 3 emissions, we have identified significant indirect sources in accordance with the principles of the GHG Protocol Scope 3 and, based on quantitative significance, impact, data availability, and accuracy, included other significant indirect sources in the scope of the inventory.

In 2022, we reviewed the calculation method of our GHG Scope 3 emissions, and adopted the life cycle assessment (LCA) to calculate the Scope 3 emissions to improve the reliability and accuracy of our data and to ensure they are aligned with our zero carbon goals. Furthermore, we used the LCA method to retrospectively the carbon emissions in 2020 and 2021. These changes include:

- We combined the concept of circular economy, introduced carbon footprint tools, completed the carbon footprint report of all commercial PC products (including Chromebook) and representative desktop PC and monitor products with life cycle assessment (LCA), and apply each [product carbon footprint data](#) to calculate the Scope 3 Category 1 emissions from procurement of raw materials and Category 12 emissions from product end-of-life treatment of sold products to improve the completeness and accuracy of carbon emission data.
- Acer collaborates with outsourced transportation suppliers, including shipping companies and logistics providers, to calculate the carbon emissions generated during the transportation process and the reduced carbon emissions for Acer. More than 90% of our outsourced shipping companies and logistics providers have joined this mechanism to provide direct information on the carbon emissions generated by each delivery of Acer products instead of the indirect methods of using ton-kilometers and average emission coefficients in the past. Acer's data quality for Scope 3 Category 4 and 9 emissions during transportation has thus been improved.



The total verified Scope 3 emissions, and the total Scope 1, 2, and 3 emissions have reached 6,694,195 tonnes and 6,705,684 tonnes respectively, a decrease of 23.7% compared with the previous year, resulting to the efforts of the use of sustainable materials, the energy consumption of products and a decrease in product shipments. In 2022, the supply chain is the main source of emission, including Scope 3 Category 1 emissions from purchased goods and services, Category 3 emissions from fuel- and energy-related activities, and Category 4 and Category 9 emissions from transportation and distribution, accounted for 83% of the total emissions. The emissions from products and services accounted for 17% of the total emissions. Among them, Scope 3 Category 11 emission from the use of sold products ranks the highest, followed by product end-of-life treatment.

2022 Acer Carbon Emission

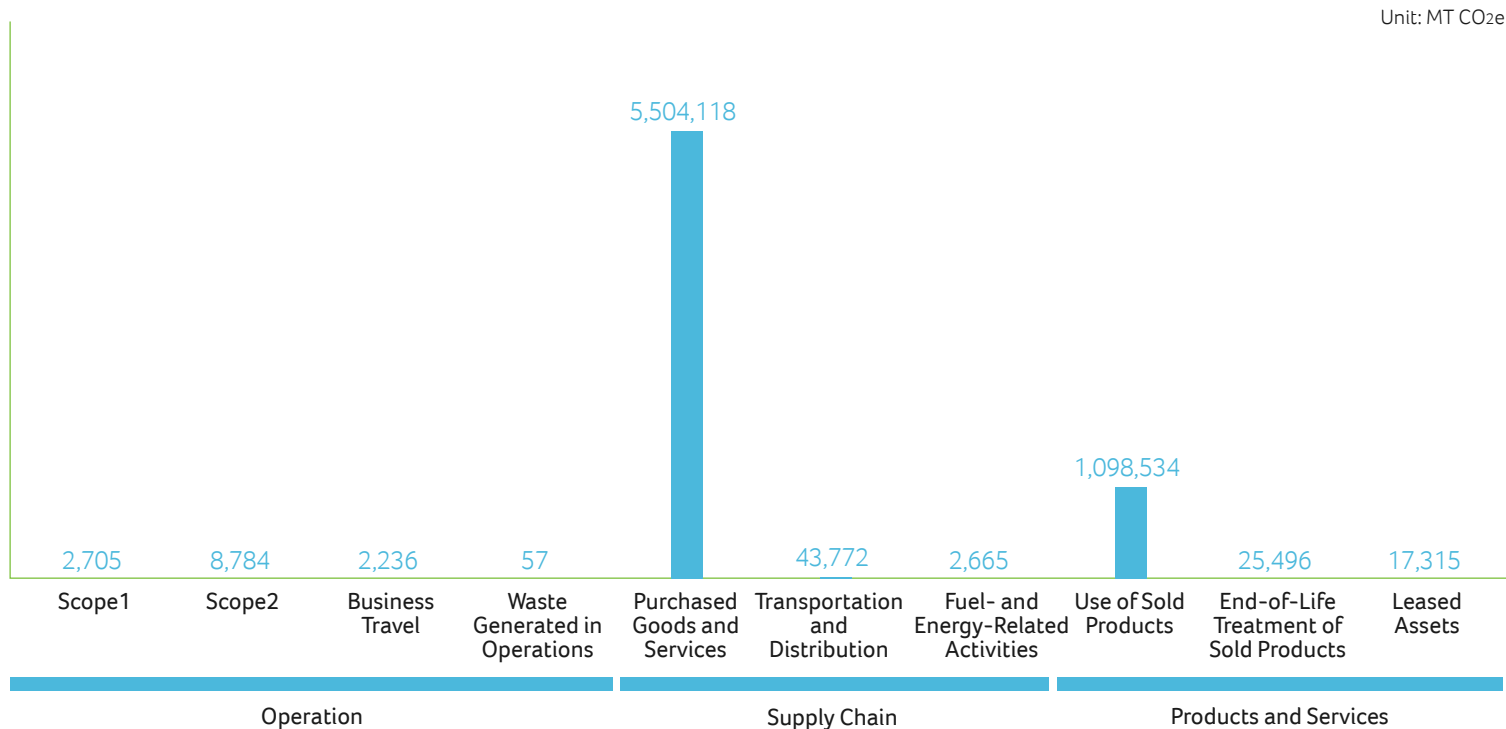

2020-2022 Acer Carbon Emission

	2020	2021	2022
Emissions from Operating Activity (Tonnes CO ₂ e)	13,077	14,395	13,783
Emissions from Supply Chain (Tonnes CO ₂ e)	6,550,901	7,108,184	5,550,554
Emissions from Products & Services (Tonnes CO ₂ e)	1,586,765	1,663,821	1,141,345
Annual Total Emissions (Tonnes CO ₂ e)	8,150,743	8,786,400	6,705,684
Scope 3 Emission (Tonnes CO ₂ e)	8,138,544	8,773,103	6,694,195
Emissions compared to the base year of 2020 (%)	-	+7.8%	-17.7%



Our Climate Actions

Acer is committed to achieve net zero emissions by 2050 and has announced the key strategies for net zero with 9 directions under 3 major pillars. We are committed to reducing our carbon footprint from the 3 major pillars in business operations, products and services, and value chains.

In 2022, Acer has implemented a number of plans including energy conservation, use of renewables electricity, product energy efficiency improvement, use of recycled materials, low-carbon logistics, and supply chain carbon reduction which are described in this report: Operation and Environment and Environmental Management: Supply Chain Climate Engagement, Product Life Cycle, and this section.

Energy management, energy saving and carbon reduction

In order to achieve sustainable environmental protection, we require operating bases with more than 100 employees and high-risk operations with less than 100 employees to promote the EMS environmental management system and follow the PDCA management cycle to promote various actions including optimization of power consumption at operating bases, implementation of energy monitoring system, replacement of chillers, setting up electric vehicle charging areas and other energy management measures to reduce carbon emissions, and ensure the system maintains effective operation through the annual third-party certification or internal verification mechanism.

In 2022, Acer introduced an EMS environmental management system with a coverage rate of 70%, please refer to Environment and Operation of this Report.

Renewables electricity Usage

Acer is committed to achieving 100% renewable electricity usage in global operations in by 2035, and to increase the shares of renewable electricity usage in the Group through self-built solar power generation systems and renewable energy purchasing. In 2022, Acer has installed 108 solar panels with a capacity of 535W in its Spanish base, which generates and consumes about 80,000 kWh of renewable electricity each year, reducing the power consumption of the base by about 20% during work hours. In addition, Acer purchased renewable energy certificates such as International Renewable Energy Certificates (I-RECs) and Guarantee of Origin (GOs) based on its global operations. The group's self-owned power plants sold 3,526,572 kWh of green power back to the local power grid, and 13,334,372 kWh of renewable energy (including REC) were used in operations, accounting for 65% of the ICT product business operations and 44% of the Group's Scope 2 consumption, which is lower than the target of 45% shares of renewables this year, resulted by the shortage of renewable electricity in some countries where our operating bases are located and the rise in global energy prices in 2022.

Acer Taiwanese headquarter has signed a long-term Corporate Power Purchase Agreement (CPPA) with a renewable energy retailer in the first quarter of 2023. It will provide about 10 million kWh of wind power every year, which is expected to greatly increase Acer's share of renewables in energy consumption to achieve the short-term target of 60% renewable electricity usage by 2025.



Business Group & Company

Business Group & Company	Electricity Usage (kWh)	Green Electricity (kWh)	Ratio of Green Electricity
Notebook, Desktop, and Monitor Related Business Group ICT product operations include power used by Acer Inc. headquarters, EMEA/Asia Pacific/Pan America, and data centers	20,477,637	13,267,533	65%
Other Business Group non-ICT product operations or subsidiaries	10,166,835	66,839	0.7%
Total	30,644,472	13,334,372	

Introduction of internal carbon pricing mechanism

In order to implement carbon reduction and respond to the international carbon border tax (such as EU's Carbon Border Adjustment Mechanism, CBAM) and carbon fee mechanism under the trend of carbon pricing, Acer introduced an internal carbon pricing mechanism to ensure various departments and operating bases to actively carry out more carbon reduction action. The mechanism also acts as the evaluation basis for the Company's introduction of innovative low-carbon solutions such as nature-based solutions, hydrogen energy technology, carbon negative technology and other projects, and we expect that through the internal carbon pricing mechanism, it can accelerate the upgrading to high-efficiency equipment and electrifying official vehicles in operating bases, realize Acer's low-carbon transformation and zero carbon emissions.

Planting tree to create a circular ecosystem

As trees can absorb carbon dioxide to mitigate climate change, and provide habitat and food sources for various organisms, their role for global carbon reduction, forest conservation and biodiversity, and recycling cannot be underestimated. Acer encourages everyone to jointly create a circular ecosystem by planting trees. **In 2022, we have planted more than 70,000 trees in our operating bases around the world.**

Among them, Acer UK has collaborated with Ecologi to plant trees and supported related projects such as rainforest protection. As of March 2023, more than 73,000 trees have been planted. For information on the locations of trees and more, please visit [Ecologi's website](#).

Acer also launched the "Green Deals" initiative in 14 European countries including the United Kingdom, Ireland, Germany, Austria, Italy, France, Poland, the Netherlands, Spain, Switzerland, Denmark, Sweden, Norway, and Finland. Acer have partnered with One Tree Planted to plant trees for purchases of notebooks with Green Deals through Acer's online store where a total of 4,697 trees were planted in 2022, an increase of 111% compared to 2021.

In Taiwan, Acer invited employees of our partners and suppliers to participate in the "21-Day Challenge" and encouraged everyone to take green actions. The event donated 8,000 trees in the four operating bases to commemorate the success of this event.

Moreover, through the collaboration of Acer's Gold-level Green Mark Hotel - Aspire Resort, we spent three weeks to reuse the idle land, plant trees, and conduct afforestation by planting 0.5 hectares of Taiwan Acacia and taking action to help our planet.



07

INCLUSIVE WORKPLACE AND SOCIETY

Employees are Acer’s most important asset, and we are committed to ensuring they are fairly treated and respected and to creating a safe and healthy working environment. By putting our core competencies to society, we strive to use our resources and influence to serve as a stable force for progress.

- **Human Rights Protection** 118
- **Attracting and Developing Talent** 125
- **Health and Safety in the Workplace** 142
- **Digital Inclusion and Social Philanthropy** 148



Selected as one of the best employers in the world by Forbes 2022



Selected as one of Global Women Friendly Companies by Forbes 2022

0

In 2022, no major workplace disasters or accidents

Note: not including traffic accidents

Human Rights, Diversity, and Equality of Opportunity

Indicators related to GRI/SASB
GRI 405, 406, 407, 408, 409, 412

Policies/ Commitments

Please refer to the section of Human Rights Protection in this chapter

Tracking Mechanism

- Acer's Grievance Mechanism (e.g. whistleblower mailbox)
- Result of the promotion of training and public mechanism
- Supervision and reflection mechanism of the union and labor-management meetings
- Oversight mechanism of government agencies

Action Plan

- Internal promotion of human rights and equality awareness
- Strengthen human rights protection and equality-related training
- Implement human rights and equality policies in the process of compensation, promotion, development, and advancement
- Allow employees to safely and anonymously report any human rights violations and misconduct

Stakeholder Engagement and Effectiveness

- Employees: Through the union, labor-management meetings, an appointment with Jason (face-to-face communication with the chairman), mutual discussion on important human rights issues, such as salary, benefits, and working environment
- Suppliers: Advocate important human rights issues and practices, such as living wages, no child labor, no forced labor at suppliers' conferences
- Shareholder: To communicate the operational and profitability status and report on the Company's ESG efforts at the shareholders' meeting
- Community: Demonstrate humanistic care for the community through occasional community activities, such as caring for the elderly who live alone, caring for disadvantaged children, etc.

Medium- and Long-Term Goals



Enhance human rights-related training and raise awareness of equality and multiculturalism among Acer employees.



Establish a diversified corporate culture and achieve parity in all measures (e.g., recruitment, promotion and compensation) based on employees' contribution.



Aim to be a leading global diversified company, providing equal opportunities and diversity for our employees.

2022 Goals



With a focus on human rights-related training, the training targets for 2022 are: 10 hours at headquarters, 6 hours at EMEA headquarters, 8 hours at PanAsia Pacific headquarters, 7 hours at Pan-American headquarters, and 8 hours at China headquarters.

Status as of 2022



8.8

The human rights training provided in 2022 is diverse, such as the "Occupational Safety Law - Prevention of Violations in the Performance of Duty" awareness course, information security awareness, personal data protection, integrity management and business conduct standards, and occupational safety and health education training, etc. The number of hours attended at headquarters and regional operations exceeded the target set for 2022, with an average of 8.83 hours.

2023 Goals



The training targets for 2023 are: 10 hours for headquarters, 7 hours for EMEA headquarters, 9 hours for PanAsia Pacific headquarters, 7 hours for Pan-American headquarters, and 8 hours for China headquarters.

Human Rights Protection

Human Rights Policy

Acer believes that every member of our staff deserves to be treated fairly and with dignity. We strive to protect the human rights and basic freedoms of our staff, providing equality of opportunity, protection of personal privacy, channels for the free and safe communication of opinions, and a safe, healthy working environment. We have established the [Acer Group Human Rights Policy](#), which applies to all Acer Group companies and organizations and protects employees, suppliers and customers whose human rights may be at risk through Acer's efforts to implement human rights protection. We also expect our partners to meet the standards of this policy in order to uphold human rights. In addition, the [Acer Standards of Integrity and Business Conduct](#) refer to the United Nations Declaration on Human Rights, the International Labor Organization (ILO) Declaration of Fundamental Principles and Rights at Work, and the United Nations Guiding Principles on Business and Human Rights, and require all associates, board members, beneficiaries, policy-relevant promoters, affiliates, vendors, channel partners, contractors, and others who do business with Acer to comply with them.

Human Rights Management Processes

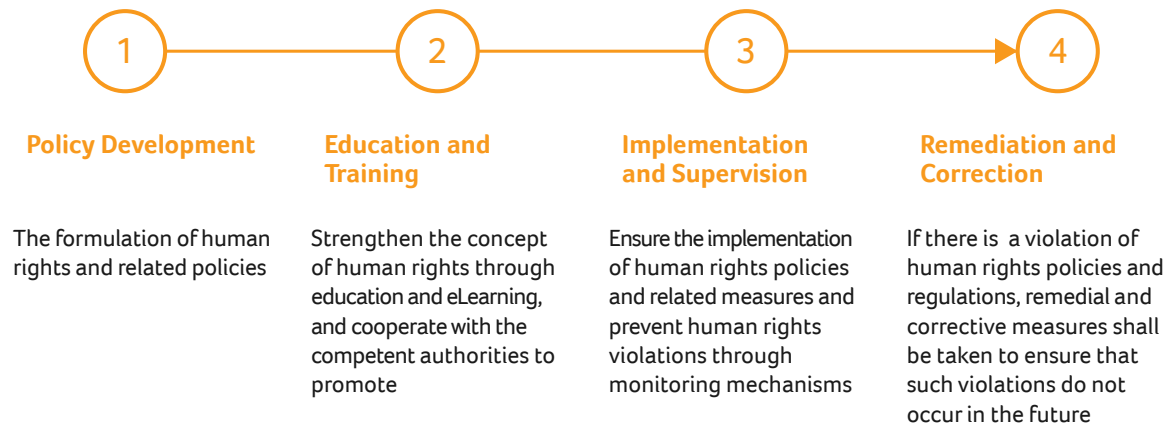

Assessment of Potential Human Rights Issues

Assessing potential human rights issues is part of Acer's risk management, with such issues identified, assessed, and discussed by members of the Risk Management Working Group. The responsible departments then formulate, implement, and manage mitigation actions for issues so identified. Human rights issues mainly affect: Acer employees, employees of suppliers (third-party employees), and children. The human rights risk assessment conducted in early 2023 identified the following human rights risks for 2022: forced labor, freedom of association, equal pay, discrimination, child labor, and other issues.

Potential Impacts and Risks Relating to Human Rights with Mitigation Actions



Children

Topic / Actual or Potential Impact	Preventive or Mitigation Measures	Tracking or Remediation Mechanisms
Child Labor Issues		
<ul style="list-style-type: none"> • Risk of violation: Employment of child labor is illegal and the company is subject to legal sanctions. • Reputational impact: Employing child labor affects the company's reputation, not only through social criticism, but also through the possibility of a general boycott of the product • Physical and psychological damage: The risks of employment of child laborers can lead to physical or psychological trauma. • Risk of legal action: If a child worker has an accident while working, the Company must face litigation and pay a high amount of compensation 	<p>Supplier:</p> <ul style="list-style-type: none"> • Human rights training for suppliers and procurement staff <p>Acer :</p> <ul style="list-style-type: none"> • The Standards of Integrity Management & Business Conduct regulates the minimum working age (i.e., no child labor) and ensures that all suppliers comply with these regulations. • Training on the risks associated with the employment of child labor in the Standards of Integrity Management & Business Conduct 	<p>Annual supplier audits and tracking, confirmation of defective improvement actions</p>



Acer Employees

Topic / Actual or Potential Impact	Preventive or Mitigation Measures	Tracking or Remediation Mechanisms
<p>Forced Labor</p> <ul style="list-style-type: none"> • Human Rights Risk: Forced labor can cause employees to suffer physical and mental abuse, resulting in serious physical and mental health problems. • Talent risk: Forced labor can lead to a loss of talent, requiring the company to invest more in rehiring and training employees. • Legal Risks: Forced labor is sufficient to expose Acer to legal sanctions, including fines, litigation, and damage to brand reputation. • Health risks: Forced labor can lead to serious injury or even death, which not only deprives the company of talent, but also causes psychological trauma to their family. 	<ul style="list-style-type: none"> • All work is voluntary and employees are free to leave or terminate their employment at any time in compliance with labor laws and regulations. • Offices around the world also employ temporary workers, dispatchers and outsourced staff in accordance with local laws. • The RBA Code of Conduct prohibits any form of forced labor in the supply chain and requires suppliers to comply with the Code of Conduct and regularly audits the compliance status of suppliers. • Conduct training on prevention of workplace abuse and actively educate supervisors on the risks of forced labor • Require supervisors to strictly comply with the working hours regulations of the labor standard laws of each country and strictly enforce the daily clocking system to prevent exceeding the legal working hours 	<ul style="list-style-type: none"> • Management: The department manager is responsible for supervising and proactively ensuring that all human rights measures are implemented. • Whistleblowing: Keep track of possible human rights obstruction issues within the organization through whistleblower.acer@acer.com • Employees: Every employee is a tracking mechanism. Each employee is responsible for contacting Acer Group management, Acer Human Resources or Legal if he or she believes that any action would constitute a violation of the Acer Group's Standards of Integrity Management & Business Conduct, or if he or she sees or hears of illegal or unethical conduct affecting the Acer Group, or if he or she knows of an individual who has engaged in dishonest, disruptive, illegal or harmful conduct against the best interests of the Acer Group.
<p>Freedom of Association</p> <ul style="list-style-type: none"> • Speech suppression: Interfering with employee participation in the decision-making process in a way that harms the common interests of the company and its employees. • Reduction of operational transparency: When the freedom of association is restricted, the power of oversight organizations may decrease, and the transparency of their operations may also diminish. • Disrupting cohesion: When freedom of association is denied, it can prevent the formation of common interests and values among employees. 	<ul style="list-style-type: none"> • Implementation of human rights protection and education training • Organize quarterly labor-management meetings to improve communication with employees • Provide a variety of employee communication channels • Conduct global Employee Engagement Surveys, analyze the results from multiple perspectives, and take necessary actions to improve (e.g. strengthen employee development through diverse online learning activities) 	<ul style="list-style-type: none"> • Auditing Office: The Audit Office is responsible for tracking and integrating cases of human rights violations, and integrating departments responsible for investigating and requesting each department to ensure that the incident does not occur again.
<p>Equal Compensation</p> <ul style="list-style-type: none"> • Low employee morale: When employees feel they are not being paid fairly for their work, it can lead to dissatisfaction and decreased motivation. • Increased turnover: When employees feel they are not being fairly compensated, they may start looking for other job opportunities, resulting in a high turnover rate for the company. • A culture of distrust: A lack of fair pay creates resentment among employees, which ultimately affects the overall atmosphere and culture of the company. • Violation of the law: Unequal compensation can lead to legal litigation, which in turn can have a negative impact on the company's brand reputation. 	<ul style="list-style-type: none"> • The Standards of Integrity Management & Business Conduct emphasizes fairness, which means treating all employees with respect and fairness. • Strengthen the awareness of workplace equality among supervisors and colleagues through training on integrity management and business conduct standards • Regularly evaluate the gender pay gap and actively increase the proportion of women in executive positions • Salary is given only with reference to the rank structure and performance appraisal results. 	<ul style="list-style-type: none"> • Integrating third-party psychological counseling services: Provide crisis management and counseling services to prevent or remedy human rights problems.
<p>Discrimination</p> <ul style="list-style-type: none"> • Decline in job satisfaction: Indulging in workplace discrimination can lead to lower overall satisfaction and morale. • Decline in productivity: A discriminatory work environment can reduce employee productivity and efficiency. • Decline in competitiveness: Workplace discrimination leads to a less diverse and inclusive workplace. • Legal consequences: Discrimination may result in legal litigation and damage to the company's reputation and financial condition. 	<ul style="list-style-type: none"> • Anti-discrimination education for all employees through ethical management and business conduct code training • Respond promptly to any complaints of undue discrimination • Implementation of Workplace Sexual Harassment Prevention Measures, Complaints, and Disciplinary Actions • Clarifying Complaints Channels, Operating Procedures and Disciplinary Regulations • Provision of Sexual Harassment Prevention Training Courses 	



Third party employees

Topic / Actual or Potential Impact	Preventive or Mitigation Measures	Tracking or Remediation Mechanisms
Equal Compensation		
<ul style="list-style-type: none"> Decline in organizational performance: Unequal pay can lead to low morale and dissatisfaction among employees, which in turn affects the performance and efficiency of the organization. Talent Turnover: If employees feel they are not being reasonably rewarded for their contributions, they may look for better opportunities, resulting in talent loss. Damage to brand image: Pay inequality can have a negative impact on a company's brand image. 	<ul style="list-style-type: none"> Regularly survey the living wage of outsourced staff Ensure that the outsourced staff enjoys the same good working environment and conditions as the regular staff Give outsourced staff equal opportunities to improve their capabilities 	Acer conducts an annual review of all suppliers in the first quarter of each year to keep track of progress.
Forced Labor		
<ul style="list-style-type: none"> Human Rights Risk: Forced labor can cause workers to suffer physical and mental abuse, resulting in serious physical and mental health problems. Legal Risks: Forced labor exposes Acer to legal sanctions, including fines, litigation, and damage to brand reputation. Health risks: Forced labor can lead to serious injury or even death, which not only deprives talent, but also causes psychological trauma to their family. 	<ul style="list-style-type: none"> Participating in Responsible Business Alliance (RBA) to gain insight into trends among international companies and practical experience of members. In Supplier Communication Meetings, we promote and communicate our requirements regarding human rights issues like child labor, forced labor, and conflict minerals. Complying with California Transparency in Supply Chains Act, British Modern Slavery Act, Australia Modern Slavery Act. 	Implementing Slavery and Human Trafficking Policy, Measures for Remedying Child Labor and Forced Labor, and Supplier Working Hours Policy.

Human Rights Training

In 2022, we continue to conduct training on human rights protection issues for employees worldwide, offering education and training courses on issues such as business standards of conduct, anti-corruption, privacy, safe and healthy working environments, and sexual harassment prevention. It is to create a friendly work environment built around equality, tolerance, and respect. The content of training related to human rights protection is adapted to the needs of different local laws and regulations to ensure that employees can fully comply with local laws and regulations in their work. The scope of executive education and training includes employees from all over the world, including Acer headquarters, Pan Asia Pacific operations headquarters, EMEA operations headquarters, Pan-American operations headquarters, and China operations headquarters, a total of five regions.

2022 Human Rights Protection Education and Training Participation and Hours

Region	Number of Trainees	Course Hours	Number of People	2022 Average Hours of Training Per Person	2022 Targeted Training (hours)
Headquarters	7,449	27,115	2,264	11.98	10
EMEA	3,540	13,894	2,039	6.81	6
Pan Asia Pacific	3,661	13,246	1,438	9.21	8
Pan-America	1,630	5,320	638	8.34	7
China	879	3,457	442	7.82	8
Total	17,159	63,031	6,821	8.83	

Anti-discrimination and harassment

Human Rights Protection Education and Training Hours

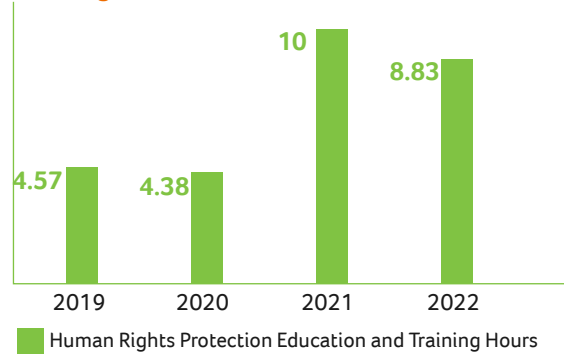

The "Occupational Safety and Health Act-Prevention of Violations in the Performance of Duty" course is designed to help supervisors understand the content and prevention concepts of the Occupational Safety Law, and to explore effective practices through case studies and experience exchange. In 2022, a total of 12 classes held.

Acer values equal opportunity for its employees and does not tolerate any harassment in the workplace. To maintain gender equality and dignity at work, and to provide a channel for employees to complain about unlawful workplace abuse, so that employees are not subjected to verbal, physical, psychological, sexual harassment and gender discrimination in the workplace, we have established prevention and control measures, complaint and disciplinary measures, and specified complaint channels, operational procedures and disciplinary regulations.

The relevant anti-discrimination policies are expressly set out in the Standards of Integrity Management & Business Conduct and include:

• Equal opportunity

Respect for employees and the creation of a diverse culture, committed to maintaining a non-discriminatory work environment; to provide equal employment opportunities for employees and job seekers, without discrimination on the basis of race, color, age and other factors.

• Harassment-free work environment

No harassment will be tolerated in the work environment. Harassment includes actions, words, written expressions or objects that create an intimidating, malicious, or offensive work environment.



Procedures for Notification of Discrimination and Harassment

- 1 Notification**
 All information regarding an event should be communicated to the department head if the event does not involve a director or top management, or it shall be communicated to the independent directors or supervisors if a director or top management is involved.
- 2 Verification**
 The responsible department and department head should verify the facts immediately.
- 3 Non-compliance handling**
 If it is determined that the notified party has indeed violated laws, regulations or Acer Group policies and ethical management rules, the offender shall be immediately requested to cease such conduct and be dealt with appropriately.
- 4 Corrective measures**
 For confirmed incidents, Acer Group shall assign the relevant departments to review the internal control system and related procedures, propose corrective measures, and prevent recurrence.

Diverse Communications Channels

We provide a variety of communication channels for staff. For example, in Taiwan, quarterly labor-management meetings (Employee Representatives Organization) are held to communicate with both employers and employees regarding employees' rights and needs. Currently, the countries and regions with trade union organizations are Italy, France, Germany, the Netherlands, Spain, and China (Shanghai), and in 2022, the percentage of total employees covered by group agreements is 11.26%, mainly in Europe and China. In Taiwan, we communicate with the Chairman of the Board of Directors through regular face-to-face communication (contract with Jason), labor-management meetings (Employee Representatives Organization), and employee welfare committees.

Each affiliated company holds Employee Representatives Organization meeting four times a year to collect proposals from their respective companies, such as work rules, friendly environment of each company, work procedures, business discussions, etc.

However, for group-level issues, such as optimizing group systems, improving workflow, livelihood services, hardware and other related proposals, they will be forwarded to the parent company (Acer) for discussion and resolution, and will be replied to the related companies.

There is also a smooth internal communication channel in each of our global offices. In Thailand, for example, the company holds a general meeting on the first business day of each year to communicate the annual business plan and strategy to employees. Each quarter, employees can ask questions directly to their supervisors during business and product meetings, and the HR department compiles all questions and answers after the meeting and sends them to all employees for reference.

For suppliers, we also hold annual Supplier Communication Meetings to promote and communicate our requirements regarding human rights issues like child labor, forced labor, and conflict minerals.

Internal Communication Structure of Acer



Face-to-Face Communication

- **Communication meeting with Jason, the Chairman of the Board of Directors**

This is an opportunity for colleagues to meet face-to-face with the Chairman of the Board of Directors to make suggestions and communicate with him about the company's policies, development direction and management.

- **Labor-management meetings (Employee Representatives Organization)**

The Chairman and Global CEO holds quarterly labor-management meetings (Employee Representatives Organization), in which the company's first-level executives communicate directly with selected employee representatives in each office to respond to employee issues and suggestions and make rulings, and assign staff from relevant departments to solve problems and follow up to improve the company's operational and management efficiency.

- **Chairman & CEO's Message**
- **Occupational Welfare Committee**
- **Volunteer Exchange and Sharing Session**
- **Club Exchange Communication Meetings**
- **Employee Assistance Program**
- **HRBP provides smooth communication channels and offers necessary assistance from the organizational side.**



Employee Engagement Reflections

- **Employee satisfaction survey**

Employee satisfaction surveys are conducted regularly every year to understand the organizational climate and to conduct in-depth interviews and develop improvement plans for major issues.

- **Stakeholder Reporting and Grievance Channels**

In order to protect the rights of stakeholders, promote communication with stakeholders, and strengthen corporate governance, when an Acer employee is found to have violated Acer's Standards of Integrity Management & Business Conduct, any wrongdoing, or corporate governance activities, he or she may report the matter through the stakeholder reporting and grievance channels and have the matter handled by a dedicated supervisor.

- **Workplace Sexual Harassment Prevention Measures and Complaints Mailbox/Hotline**

- **Dedicated Mailbox/Hotline for Reporting of Wrongful Actions in the Course of Duties**

We maintain gender equality and dignity at work, and provide a channel for employees to complain about unlawful workplace abuse. We have established prevention and control measures, complaint and disciplinary measures, and specified complaint channels, operational procedures and disciplinary regulations so that employees are not subjected to verbal, physical, psychological, sexual harassment and gender discrimination in the workplace.

- **Nursing Hotline**



Announcements

- **Acer Daily News**

Acer Daily News and Acer Good News are a quick way for employees to get a daily summary of news about the Group and a weekly summary of good news about the Group, which helps them to understand the overall business development of the company and to gather a sense of identity and honor among the employees in the Group.

- **Small gift of care**

The chairman of the board cares for the employees who have confirmed the diagnosis. For the employees who have reported the diagnosis, the chairman of the board will send the chicken soup with a small care card signed by the chairman the next day, wishing the employees to recover soon and resume the normal rhythm of life and work.

- **Employee Welfare Committee APP**

On important festivals, we organize online activities or posts to convey warm care and unite the emotions of our employees through our internal employee app and community.

- **Acer Good News**

- **Staff Fitness Center App**

- **Acer Family Social Media Page**

- **Acer Volunteers Social Media Page**



Labor-Management Meetings (Employee Representatives Organization)

Effective two-way communications can further cement the unity and sense of identity among staff. At the same time, it helps further develop an organizational culture wherein the staff are respected and cared for, thus creating a win-win situation for both the Company and its staff.

Acer is committed to the principles of human rights, diversity, and equality of opportunity and rigorous in our compliance with legal requirements, including organizing regular labor-management meetings to establish smooth communication between employer and employees.

We regularly communicate with labor representatives regarding the company's business performance results and future development goals and strategies. Labor representatives share their opinions and suggestions with the Company's management team, establishing a positive relationship with staff, and thus creating a work environment of high participation.

Employee Representatives Organization, headed by the chairman and CEO, with department general managers, top management from support departments, and staff representatives in attendance focus on discussing and implementing resolutions regarding operations management, work environment, and employees' rights.

In 2022, employees in Taiwan proposed to important proposals through labor-management meetings (Employee Representatives Organization), such as suggesting that the company should provide corresponding courses with built-in software, strengthen employee training programs, improve employee training opportunities, and optimize the environment and facilities for employee parking.

Employee Engagement Surveys

Our Global Human Resources Department conducted a 2023 Employee Engagement Surveys from January to February 2023 to understand the organizational climate and to conduct in-depth communications and interviews to address key issues and develop improvement plans.

The global employee engagement surveys covers six dimensions. The coverage rate of the 2023 Employee Engagement Surveys reached 100%, with a response rate of 78.2%, a decrease of 7.8% from last year. The Global Employee Engagement Surveys uses a scale of 1 to 5 (i.e., strongly disagree ~ strongly agree), and respondents can also choose the "don't know" option if they do not have enough information or feelings about the question asked.

In addition, 78.16% of our global workforce are actively engaged with the company, up 5.16% from last year, and we plan to reach our goal of 80% global employee recognition by 2025.

Acer was named to Forbes Magazine's "2022 Global Best Employers" and "2022 Global Best Women-Friendly Companies" lists. This is the third consecutive year that Acer has been named a Forbes Global Employer of the Year, and the ranking has improved each year. That demonstrates that the Group is among the top companies in the world in terms of corporate influence and image, talent development, gender-friendliness and corporate social responsibility. We are committed to improving employee engagement, enhancing operational growth momentum, and continuing to provide the best workplace experience for Acer employees.

The Company has also introduced a new management training program to respond employees' expectation for their job development, and the Human Resources Business Partner (HRBP) is following up with the managers on their advancement status.

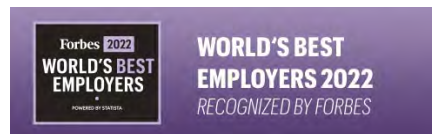
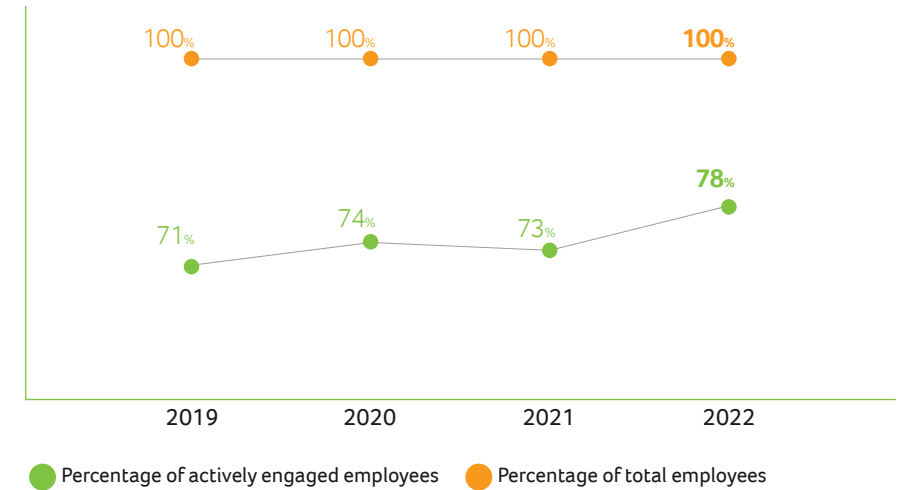



Living Wage

Living wage is the income earned by an employee during legitimate hours of work that is sufficient to support the basic necessities of life in a decent manner. In recent years, Acer has attached great importance to the standard of living wages for its employees and has asked its suppliers and contractors to make efforts to achieve the standard of living wages for their employees. A good living wage not only reduces the risk of labor problems, but also attracts and retains talent, increases worker productivity, and customer satisfaction, thereby promoting long-term company growth.

Acer Commitment	Adoption of Methodology
<ul style="list-style-type: none"> Employees Although 100% of Acer employees are currently paid above the local living wage standard, we conduct annual reviews to ensure that everyone is paid above the living wage standard. Suppliers We are committed that at least 75% of our Tier 1 suppliers pay the wage at the local living wage level by 2025, and at least 80% of them by 2030. To fulfill our commitment to closing the gap, suppliers pay the wage below the living wage have been asked to submit action improvement plans and achieve their targets within the required commitment time frame. Acer conducts an annual stock-take of all suppliers in the first quarter of each year to keep track of progress. We are committed to maintaining our business relationships even though the supplier may drive up the cost of services. Contractors We are committed to ensuring that at least 70% of our contractors will pay the wage at the local standard living wage level by 2025, and at least 80% by 2030. To fulfill our commitment to closing the gap, we have asked contractors with below-standard living wages to submit action improvement plans and achieve their goals within the required timeframe. Acer conducts annual reviews of all contractors in the first quarter of each year to keep track of progress. We are committed to maintaining our business relationships even though contractor may drive up the cost of services because they increase the wage. 	<p>Regarding the methodology for estimating a living wage, we took the following two steps with reference to Anker's methodology ^{Note 1}</p> <p>The first step is to survey the (decent) cost of living of employees and families in a given area, which is the standard living wage. ^{Note 2}</p> <p>The second step is to determine whether we are paying wages (excluding overtime, bonuses and benefits) above or below the standard, and to request improvements from entities whose average wages are below the living wage standard (such as Acer's regional offices, contractors or suppliers).</p> <p>Note 1: Anker Methodology for Estimating a Living Wage Note 2: Reference to the cost of living standard data for countries around the world provided by Numbeo, the world's largest cost of living database, as of December 2022. Numbeo Database: https://www.numbeo.com/common/</p>

Living wages of the three major groups

Staff

In February 2023, we conducted a living wage survey of Acer's top three operating regions, including Taiwan, China, and the U.S. The survey showed that the average living wage of employees in these three regions was above the norm.

Contractor

In January 2023, we conducted a formal living wage survey of contractors worldwide.

Of the 24 contracting companies surveyed globally, 19 (79%) had a living wage above the norm.

For contractors that are currently below the living wage standard, we have requested remedial measures, including a commitment to pay a living wage that meets the standard and a plan for improvement.

Acer will take proactive action to monitor these contracting units and measure the effectiveness of their improvements.

Supplier

From late 2022 to early 2023, we conducted a formal living wage survey of Tier 1 suppliers. The survey results show that 13 of the 16 providers surveyed, or 81%, offer a living wage above the norm. For suppliers that are currently pay the wage below average, we have taken the following remedial measures:

Short-term (2023-2024)

Require all suppliers to commit to paying an appropriate living wage to cover the basic costs of a modest (but decent) living, and require those below the average to initiate improvement programs. Acer conducts annual reviews and provides the necessary care and counseling assistance.

Mid-term (2025~2030)

Suppliers are required to improve productivity, profitability, and quality in order to increase compensation; suppliers are required to regularly check whether living wages are being met with reference to living wage standards, price increases, and employee feedback. Acer will conduct annual reviews on an annual basis.



Attracting and Developing Talent

Talent Attraction and Retention

Indicators related to GRI/SASB
GRI 201, 401, 402

Acer strives to provide a working environment that creates staff who are passionate, positive, and dare to dream. This demands consideration and communication that supports and encourages our team. Through competitive compensation, we are able to attract and retain talented people; through promoting work-life balance, we care for our staff's mental and physical health; through systematic personnel training, we activate the power to change the world.

Policies/ Commitments

We are committed to creating a work environment that celebrates empowerment, responsibility, full communication, creativity, efficiency and teamwork. We recruit a wide variety of talented people by adhering to the principle of equal opportunity and hiring employees in compliance with labor laws and regulations in various locations around the world.

Stakeholder Engagement and effectiveness

Join "TALENT, in Taiwan, Taiwan Alliance for Sustainable Action for Talent" to implement the indicators of "Organizational Communication" and "Physical and Mental Health", and start the following actions for sustainable development of talent:

- Through the establishment of an employee communication platform and a mechanism for expressing opinions, we not only create more opportunities for cross-organizational interaction and communication, but also understand the needs of employees in real time.
- To create a positive and healthy workplace atmosphere and enrich Acer's life, we provide a full range of comprehensive welfare planning, so that employees can take care of both physical and mental health

Action Plan

- We also provide competitive pay and benefits, humane management, and a robust path for promotion and career development.
- In line with the Company's strategic development direction, we work to optimize the organizational capability of both core and new businesses in order to fully leverage the synergies of the Group.
- We provide a diverse educational and developmental environment in order to attract and retain outstanding talent.

Tracking Mechanism

- Weekly group meeting progress tracking, monthly departmental meeting results report, monthly manpower recruitment report compilation

Medium- and Long-Term Goals

Strengthen the best employer brand image to attract and retain talented people

Provide competitive compensation/ benefits to retain the company's best talent

2022 Goals

Facing the post-epidemic era, we continue to develop diversified digital recruitment channels and methods

Assist IPO companies within the Group to leverage the Group's synergy to increase exposure and visibility

60% Maintain at least 60% of the participants in the Company's shareholding trust

Proactively cooperate with schools and government agencies, organize corporate visits or other channels to enhance employer brand image

The recruitment campaign actively integrates the Company's sustainable management strategy and project humanity, focuses on environmental and educational issues, and spreads the concept of sustainability to potential candidates.

Status as of 2022

Please see the "talent recruitment" section in this report

2023 Goals

Create opportunities and platforms for internal talent flow

Strengthen and enhance employer brand image

Continuously promote sustainable management strategies and project humanity to external parties and implement them in recruitment activities

Collaborate with schools and government agencies to organize recruitment, visits or other cooperative projects to develop diversified recruitment methods

Continuously assist and strengthen supervisors' ability to use career personality questionnaires, numerical and inferential assessment tools to facilitate accurate selection



Staff Structure

Staff Employment

As of the end of December 2022, Acer had 7,725 employees (Note 1) worldwide: including 7,308 regular employees, of whom 4,507 were male and 2,801 were female; and 417 temporary employees, of whom 317 were male and 100 were female. This Company's staff are spread across 40 countries/territories. Of these, 1,392 were supervisors, 2,323 were professionals, 858 were executives, and 3,152 were technicians by job category (Note 2); 3,301 were in Taiwan, 1,829 were in Pan-Europe, 1,602 were in Pan-Asia, 560 were in Pan-America, and 433 were in China; the average age was 41 years old and the average years of experience was 9.2 years. In addition, we had 223 temporary staff, of which 175 are male and 48 female.

Note 1: Global staff figures are calculated with the total number of full-time staff and contracted staff together.

Note 2: The job categories are briefly described as follows:

- (1) Management Staff: According to the specific executive authority granted by the Company to lead the team to accomplish the organizational goals, management staffs are divided into different levels: senior management and middle/junior management.
- (2) Specialist Staff: The role is to provide professional advice, recommendations and solutions to clients or companies to achieve their goals, such as project management, marketing, business, etc.
- (3) Administrative Staff: They coordinate and manage the common affairs and resources of the Group, such as legal affairs, finance, human resources, information, etc.
- (4) Technical Staff: Responsible for the design, development, implementation, maintenance and support of various technical products and services for a specific area. Such as research and development, equipment, technical support, etc.

		Male		Female		Other (Gender is determined by the employee)		Undisclosed		Subtotal	
		Number of People	Number of People (%)	Number of People	Number of People (%)	Number of People	Number of People (%)	Number of People	Number of People (%)	Number of People	Percentage of total Employees (%)
Work Locations	Taiwan	1,994	60.4%	1,307	39.6%	-	0.0%	-	0.0%	3,301	42.7%
	EMEA	1,287	70.4%	542	29.6%	-	0.0%	-	0.0%	1,829	23.7%
	PanAsia Pacific	948	59.2%	654	40.8%	-	0.0%	-	0.0%	1,602	20.7%
	Pan America	331	59.1%	229	40.9%	-	0.0%	-	0.0%	560	7.2%
	China	264	61.0%	169	39.0%	-	0.0%	-	0.0%	433	5.6%
Age	Under 30	696	58.6%	492	41.4%	-	0.0%	-	0.0%	1,188	15.4%
	30-50	3,154	62.8%	1,870	37.2%	-	0.0%	-	0.0%	5,024	65.0%
	50 and Over	913	64.8%	496	35.2%	-	0.0%	-	0.0%	1,409	18.2%
	Age Undisclosed	61	58.7%	43	41.3%	-	0.0%	-	0.0%	104	1.3%
Job Category	Technical Staff	2,283	72.4%	869	27.6%	-	0.0%	-	0.0%	3,152	40.8%
	Specialist Staff	1,216	52.3%	1,107	47.7%	-	0.0%	-	0.0%	2,323	30.1%
	Management Staff	956	68.7%	436	31.3%	-	0.0%	-	0.0%	1,392	18.0%
	Administrative Staff	369	43.0%	489	57.0%	-	0.0%	-	0.0%	858	11.1%
Employment Contract	Regular Staff	4,507	61.7%	2,801	38.3%	-	0.0%	-	0.0%	7,308	94.6%
	Temporary Staff	317	76.0%	100	24.0%	-	0.0%	-	0.0%	417	5.4%
Employment Type	Full-Time Staff	4,507	61.7%	2,801	38.3%	-	0.0%	-	0.0%	7,308	94.6%
	Part-Time Staff	317	76.0%	100	24.0%	-	0.0%	-	0.0%	417	5.4%
	Employees Without Hours Guarantee	0	0.0%	0	0.0%	-	0.0%	-	0.0%	0	0.0%

Diversity and Inclusion

We emphasize an "equal opportunity" workplace policy. We are committed to maintaining a non-discriminatory work environment by respecting and accommodating the diverse cultures of our team members. We provide equal employment opportunities to employees and job applicants without discrimination based on race, color, genetic heritage, or other characteristics protected by local laws. We remind supervisors to use the analytical data of the candidate's skill level and personality assessment as the basis for recruitment, and to recruit without bias based on their gender, age, race, etc. In addition, we promote the importance of multiculturalism to our global workforce through classroom and online training, emphasizing that Acer provides a work environment free of discrimination (including race and color). We also review demographics of our employees and leadership teams, such as BIPOC (Black, Indigenous, and people of color) data, to inform recruitment and training planning.

People with Physical and Mental Disabilities

We uphold the principle of equal employment and do not discriminate against people with physical or mental disabilities. We provide barrier-free facilities for employees with disabilities, including ramps, elevators, toilets, and parking spaces. We strive to ensure that our physically challenged associates have the right to participate in company activities, including training courses and welfare committee activities. In addition, we employ visually impaired massage therapists to provide services in our office and also employ amblyopia women to join our R&D team as our bioscientists. We partnered with "Dialogue in the Dark" social enterprise and invited our colleagues to enjoy the "Concert in the Dark". Through the feedback from our colleagues, they expressed their willingness to become friends with the visually impaired and to appreciate and empathize with different groups in the society.

Racial/Ethnic Composition of Acer America Staff

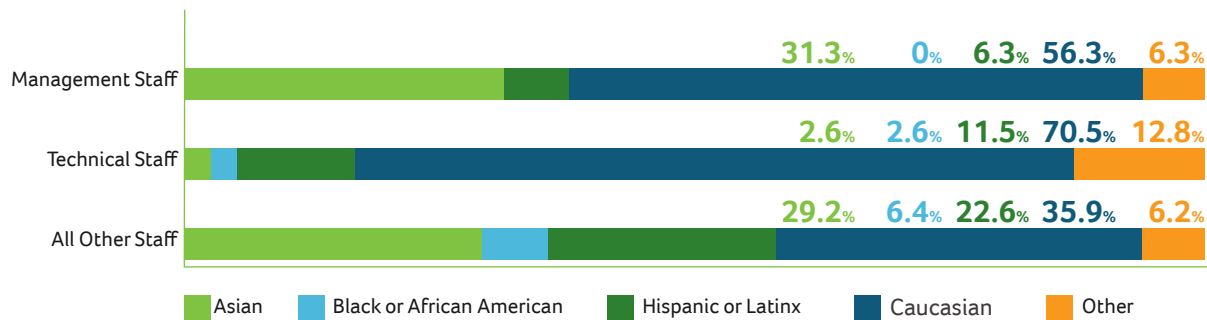

Note: According to the SASB indicators, "U.S. employees" should be disclosed according to the EEO-1 Survey Classification Guide, and management refers to employees within the two reporting levels of the CEO, and the number and percentage of employees are currently counted according to this definition.

Female employees

Acer attaches importance to human rights and gender equality among its workers. As of 2022, female staff accounted for 38% of total staff, 31% of management, and 36% of senior management.

Proportion of Female employees

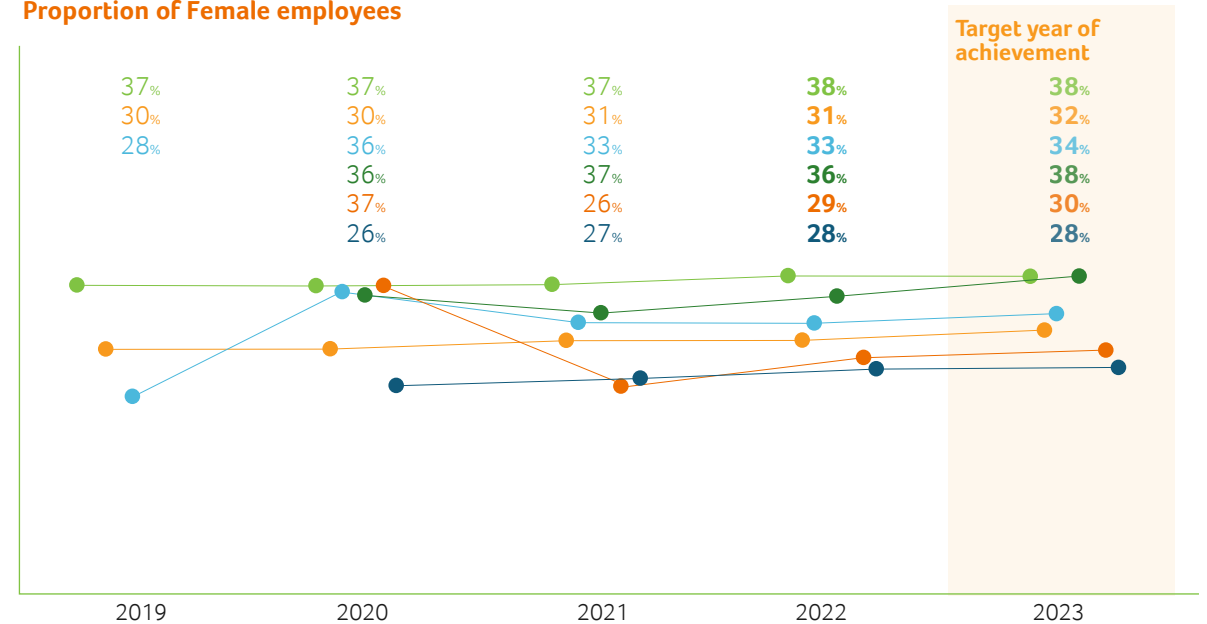

- Share of women in total workforce
- Share of women in all management positions, including junior, middle and top management
- Share of women in management positions in revenue-generating functions
- Share of women in junior management positions
- Share of women in top management positions
- Share of women in STEM-related positions

Note 1: According to Acer's internal classification principles, this refers to the sum of middle/junior level executives.

Note 2: The source of the executive officers herein is based on the list of executive officers disclosed in the Company's annual report for fiscal year 2021.

Note 3: Revenue-Generating function refers to a direct management role in a department such as sales, or a role that contributes directly to the output of a product or service.

Note 4: STEM refers to Science, Technology, Engineering and Mathematics. STEM staff members use their knowledge of science, technology, engineering or mathematics in their daily duties.



Talent Recruitment

Wherever we are in the world, Acer strives to adhere to labor laws when hiring staff. We insist on equal opportunity employment, hiring through an open selection process that does not discriminate on the basis of factors that have no bearing on work capability, including ethnicity, skin color, age, religious belief, nationality, ancestry, marital status, gender, sexual orientation, gender identity, military service, or political beliefs. With our focus on hiring the best people for the job, we have been able to assemble a diverse array of outstanding talent. We also provide competitive pay and benefits, humane management, and a robust path for promotion and career development.

In 2022, the global average percentage of staff who were new full-time hires (a total of 934 people) was 13%. In 2022, we had 960 regular employees departing globally, with an average turnover rate of 13%, a decrease from 2021, primarily due to enhanced management training to enable supervisors to understand management communication, job coaching, and performance management skills, resulting in a stronger sense of belonging to the team.

Number and Percentage of New Regular Employees in 2022 (%) - by Age Group, Gender

	Under 30		30-50		50 and Over		Age Undisclosed	
	Female	Male	Female	Male	Female	Male	Female	Male
Taiwan								
Hiring Rate (by gender)	54%	35%	17%	14%	5%	7%	0%	0%
New Staff (by gender)	146	100	141	183	9	21	0	0
Hiring Rate	44%		15%		6%		0%	
New Staff	246		324		30		0	
EMEA								
Hiring Rate (by gender)	27%	24%	8%	5%	3%	2%	0%	200%
New Staff (by gender)	10	28	26	35	3	5	0	2
Hiring Rate	25%		6%		3%		100%	
New Staff	38		61		8		2	

	Under 30		30-50		50 and Over		Age Undisclosed	
	Female	Male	Female	Male	Female	Male	Female	Male
Pan Asia Pacific								
Hiring Rate (by gender)	18%	21%	5%	9%	3%	1%	32%	36%
New Staff (by gender)	18	18	21	58	3	1	6	10
Hiring Rate	19%		7%		2%		35%	
New Staff	36		79		4		16	
Pan America								
Hiring Rate (by gender)	31%	11%	9%	9%	1%	2%	87%	49%
New Staff (by gender)	4	3	9	14	1	3	10	9
Hiring Rate	17%		9%		2%		63%	
New Staff	7		23		4		19	
China								
Hiring Rate (by gender)	9%	20%	4%	11%	0%	0%	0%	0%
New Staff (by gender)	2	4	6	25	0	0	0	0
Hiring Rate	14%		8%		0%		0%	
New Staff	6		31		0		0	
Global								
Hiring Rate (by gender)	40%	28%	11%	10%	4%	4%	52%	45%
New Staff (by gender)	180	153	203	315	16	30	16	21
Hiring Rate	34%		11%		4%		47%	
New Staff	333		518		46		37	

Note: Hiring Rate: Annual hiring rate = (number of new staff in the current year) / (number of employees at the end of the previous year + number of employees at the end of the current year) / 2



Hiring Rate (%) in 2022 - By Staff Category and Gender (Full-time Staff), Persons with Physical and Mental Disabilities (or Disabilities), and Gender

	Senior Management		Middle/Base-level Management		General Staff		People with Physical and Mental Disabilities	
	Female	Male	Female	Male	Female	Male	Female	Male
Taiwan								
Hiring Rate (by gender)	0%	0%	4%	8%	27%	18%	0.3%	0%
Hiring Rate	0%		7%		22%		0.2%	
EMEA								
Hiring Rate (by gender)	0%	0%	5%	4%	6%	9%	2.6%	0%
Hiring Rate	0%		4%		8%		0.9%	
Pan Asia Pacific								
Hiring Rate (by gender)	0%	0%	6%	4%	11%	10%	0%	1.1%
Hiring Rate	0%		5%		10%		0.7%	

	Senior Management		Middle/Base-level Management		General Staff		People with Physical and Mental Disabilities	
	Female	Male	Female	Male	Female	Male	Female	Male
Pan America^{Note}								
Hiring Rate (by gender)	0%	0%	5%	6%	13%	10%	-	-
Hiring Rate	0%		2%		5%		-	
China								
Hiring Rate (by gender)	0%	0%	4%	0%	5%	14%	0%	0%
Hiring Rate	0%		1%		10%		0%	
Global								
Hiring Rate (by gender)	0%	0%	5%	6%	17%	13%	0.5%	0.2%
Hiring Rate	0%		5%		15%		0.3%	

Note: Pan American does not collect information on physical and mental disabilities of employees.

Number and Percentage of Full-time Employees Turnover in 2022 (%) - by Age Group, Gender

	Under 30		30-50		50 and Over		Age Undisclosed	
	Female	Male	Female	Male	Female	Male	Female	Male
Taiwan								
Turnover Rate (by gender)	27%	20%	17%	17%	11%	11%	0%	0%
Departures (by gender)	74	57	140	220	18	33	0	0
Turnover rate	23%		17%		11%		0%	
Departures	131		360		51		0	
EMEA								
Turnover Rate (by gender)	45%	22%	10%	8%	10%	7%	0%	0%
Departures (by gender)	17	26	33	55	9	16	0	0
Turnover rate	28%		8%		8%		0%	
Departures	43		88		25		0	
Pan Asia Pacific								
Turnover Rate (by gender)	14%	22%	6%	11%	2%	7%	0%	0%
Departures (by gender)	14	19	26	68	2	11	0	0
Turnover rate	18%		9%		5%		0%	
Departures	33		94		13		0	

	Under 30		30-50		50 and Over		Age Undisclosed	
	Female	Male	Female	Male	Female	Male	Female	Male
Pan America								
Turnover Rate (by gender)	23%	29%	13%	9%	7%	11%	0%	0%
Departures (by gender)	3	8	13	14	7	13	0	0
Turnover rate	27%		11%		9%		0%	
Departures	11		27		20		0	
China								
Turnover Rate (by gender)	30%	20%	12%	15%	0%	0%	0%	0%
Departures (by gender)	7	4	17	36	0	0	0	0
Turnover rate	25%		14%		0%		0%	
Departures	11		53		0		0	
Global								
Turnover Rate (by gender)	26%	21%	12%	13%	8%	9%	0%	0%
Departures (by gender)	115	114	229	393	36	73	0	0
Turnover rate	23%		13%		8%		0%	
Departures	229		622		109		0	

Note: Hiring Rate: Annual hiring rate = (number of new staff in the current year) / (number of employees at the end of the previous year + number of employees at the end of the current year) / 2

Turnover Rate: Annual turnover rate = (number of departures in the current year) / (number of employees at the end of the previous year + number of employees at the end of the current year) / 2

Turnover Rate in Recent Years

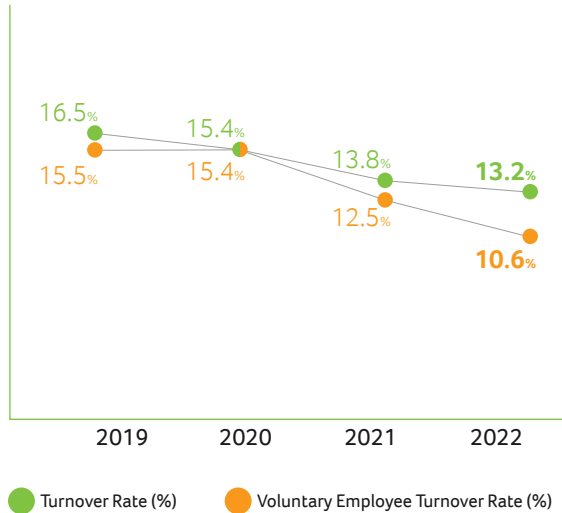

Note: The formula for calculating the voluntary employee turnover rate is: (the number of voluntary departures in the current year) / (the number of persons in employment at the end of the previous year + the number of persons in employment at the end of the current year) / 2

Percentage of vacancies filled by internal staff (%)

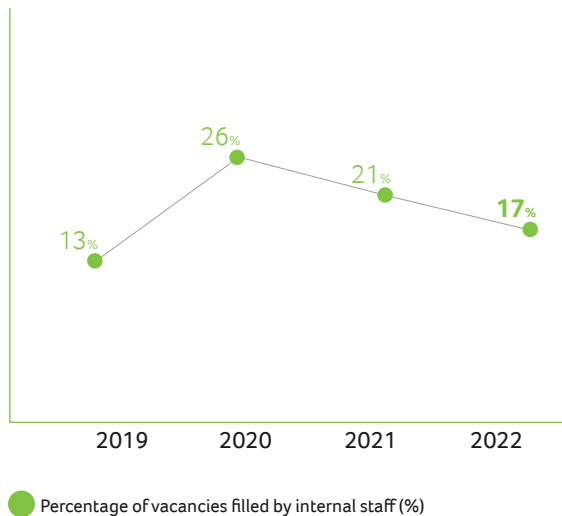

Talent Recruitment Management Processes



2022 Talent Recruitment Status

<p>Goals: Facing the post-epidemic era, we continue to develop diversified digital recruitment channels and methods</p> <p>Status</p> <ul style="list-style-type: none"> We post job vacancies on CakeResume, a website for new talent, to attract more diverse talent through different channels. In addition to the exposure through 104, Acer Career FB, Campus Edition, the official website of each university department, and internal notification letters, campus recruiting has been added to the social media Dcard, and the number of 2022 resumes has surged from over 900 in 2021 to over 1,800. 	<p>Goals: Integrates the Company's sustainable management strategy and project humanity, focuses on environmental and educational issues, and spreads the concept of sustainability to potential candidates.</p> <p>Status</p> <ul style="list-style-type: none"> Project Humanity was introduced in campus recruitment, corporate visits, and Career Exploration Month seminars, and the eco-friendly laptop series was exhibited at the campus recruitment event. So, the public can feel that Acer values environmental sustainability not only as a slogan, but also in the design of its products. 	<p>Goals: Maintain at least 60% of the participants in the Company's shareholding trust</p> <p>Status</p> <ul style="list-style-type: none"> As of December 31, 2022, excluding managers and listed subsidiaries, the total number of employees in Taiwan is 1,853, of which 1,291 are participating in the stock ownership trust, with a participation rate of 70%. <p style="font-size: 2em; font-weight: bold;">70%</p>
---	--	---

2022 Talent Recruitment Status

Goals: Proactively cooperate with schools and government agencies, organize corporate visits or other channels to enhance employer brand image

Status



May

Online corporate visit for 28 students from National Tsing Hua University

July

Acer was invited by the Youth Career Development Center to conduct a group mock interview and gave feedback to about 18 young people on interview improvement suggestions and resume writing.

October

Hosted over 30 young people to introduce ESG and convey Acer's philosophy of sustainable development

November

In cooperation with the Ministry of Labor, we organized a visit to a job market for young people and received 25 students from National Taiwan University of Science and Technology in November to give them a better understanding of industry trends and future directions.

December

Three Acer executives who graduated from National Chengchi University (NCCU) came to the campus of NCCU and held a seminar on "How to enter the technology industry - Acer seniors have an appointment with you." 103 students attended the seminar. Finally, 41 students were invited to visit Acer and share their career journey with their mentors who are also graduates of National Chengchi University. In the post-event questionnaire survey, all the participating students gave feedback that they had overturned the concept that only science and technology subjects are more suitable for the technology industry, and at the same time, the students had more expectations and possibilities for their future career.



Goals: Assist IPO companies within the Group to leverage the Group's synergy to increase exposure and visibility

Status



- The campus recruiting event used the Group's job openings as the material and introduced the characteristics of more than 10 IPO companies (such as Acer Medical, ACSI, and Altos) with videos on site. Acerpure air purifiers and acer beverage energy drinks were placed at the event to let students and job seekers know more about the other IPO companies in the group through Acer's leadership.
- In addition to introducing Acer, we also arranged for other IPO companies to introduce the company's products and share their experiences of working in IPO companies, so that more job seekers can learn about the diversity of the Acer Group and have a wide range of options for their future careers.

Goals: Forbes Magazine

Global Best Employer Best Women-friendly Company Best Employers for New Grads

Forbes magazine anonymously interviewed 150,000 employees of multinational companies in 57 countries around the world and ranked them or other companies according to their recommendations. The evaluation criteria include four aspects: corporate image and influence, talent development, gender equality and social responsibility. In 2022, Acer is not only listed as one of the world's best employers, but also as one of the best women-friendly companies and one of the best employers in the minds of freshmen.



Learn more: [World's Best Employers 2022 \(forbes.com\)](https://www.forbes.com)





Competitive Compensation

Competition is fierce in the technology market, and competition for talent is much the same. In order to attract and retain outstanding employees, we provide competitive comprehensive salary packages. When developing salary policies, we comply with labor laws of each location and do not discriminate on the basis of gender, religion, race or political affiliation. We consult salary survey information from management consultancies to ensure our salaries are competitive in each region's job market. To reward outstanding employees, we issue bonuses based on company profit and both department and individual performance; Acer Taiwan, for example, provides target rewards, and both profit-sharing bonuses and rewards.

In response to changes in workplace work styles brought about by COVID-19, the demand for computer hardware has increased significantly. In 2022, employees worldwide received an average salary increase of 4% compared to the difference between internal and market, and to encourage internal morale. The current ratios of women's base salaries and wages to those of men at each major work location are shown in the table below. Acer's compensation for employees is based on comparative market salary surveys, with no gender/race/age distinctions.

2022 Basic Salary and Remuneration (Female:Male)

	Management Staff		Technical Staff		Specialist Staff		Administrative Staff	
	Basic Salary	Compensation	Basic Salary	Compensation	Basic Salary	Compensation	Basic Salary	Compensation
Taiwan	0.91	0.91	0.82	0.82	0.89	0.89	0.91	0.91
EMEA	0.76	0.42	0.92	0.68	1.00	0.50	0.81	0.43
Pan Asia Pacific	0.75	0.62	0.48	0.61	0.92	0.80	1.06	0.98
Pan America	0.81	0.63	1.09	1.08	0.84	0.56	0.91	0.78
China	0.77	0.55	0.82	1.01	0.83	0.71	0.73	0.64

Based on the aforementioned 7,725 Acer employees worldwide who are employed from January 1, 2022 to December 31, 2022 and are full-time employees, the scope of the calculation includes all subsidiaries of the Acer Group, excluding listed subsidiaries, and includes 1,823 employees in Taiwan, 1,302 employees in Pan Europe, 985 employees in Pan Asia Pacific, 376 employees in Pan America, and 385 employees in China, for a total of 4,871 employees.

In terms of basic salary, due to the nature of the job, the ratio of female to male salary is 0.48 in Pan Asia Pacific for technicians. In addition, the overall female-to-male basic salary ratio in Taiwan, Pan-Europe, Pan-America and China is above 0.7. The salary depends on the comparative value given by the market salary survey and varies according to the planning method and the nature of the job in each region.

To meet the post-epidemic year of 2023, Acer has already planned a salary adjustment. The salary and compensation of employees will still be based on the comparative values given by market salary surveys, regardless of gender/race/age, in order to attract outstanding talents to stay.

In Taiwan, the number of full-time employees in Acer who do not hold managerial positions was 1,578 in 2021 and 1,501 in 2022. The average salary for the two years was NT\$2.19 million and NT\$1.772 million, respectively. The median salary for the same periods was NT\$1.651 million and NT\$1.442 million, respectively.



Maternity Benefits

When Acer staff are faced with the needs of parenthood, they can apply to take unpaid parental leave and, upon the completion of the leave period, return to their position. In this way, they are able to take care of their personal and familial needs. Since the 2022 law relaxed the application period of less than 6 months for baby-sitting, 7.6 percent of the employees (13) applied for less than 6 months in 2022.

Parental Leave Applications in 2022 (Acer Taiwan)

	Female	Male	Total
Number of Employees Entitled to Parental Leave in 2022	62	104	166
Number of Employees Who Took Parental Leave in 2022	12	1	13
Applicants for Parental Leave (%)	29.03%	1.92%	12.05%
Number of Employees Expected to Return to Work After Parental Leave in 2022	16	1	17
Number of Employees Who Returned to Work After Parental Leave in 2022	16	2	18
Post Parental Leave Return-to-Work Rate (%)	100.00%	200.00%	105.88%
Number of Employees that Returned to Work After Parental Leave in 2021	6	1	7
Number of Employees Still Employed in 2021 12 Months After Return	4	1	5
Post Parental Leave Retention Rate (%)	66.67%	100.00%	71.43%

Note: The source of the information is the maternity and paternity leave applicants from 2019 to 2022 who are still working at the end of 2022.

Retirement system

Acer's retirement system adheres to the regulations for each of the Company's global locations. In the Taiwan region, for example, contributions are made to staff pensions in line with the Labor Standards Act and the Labor Pension Act. Staff who were employed by Acer on or before June 30, 2005, and were covered by the old system may freely opt into the new system and enjoy the new benefits. The actuarial work for the current year's pension liability is performed in December each year, and the official version of the actuarial report is issued in January of the following year. As of the end of 2022, the company's deposits with the Bank of Taiwan under the old system totaled approximately NT\$153 million. As for the new system, the Company currently contributes 6% of employee pay, while the employees may contribute anything between 0% and 6%. In the Taiwan region, Acer also provides occasional retirement plan benefits; our retirement system exceeds legal requirements, and at least 50 years of age with 15 years service, and with management's agreement, staff can retire early. For employees whose employment relationship is terminated due to retirement or redundancy, the Company provides pensions or severance pay in accordance with the law, thus helping support their post-retirement lives or their financial needs during their transition to new employment. From 2022, we provide a relatively subsidized "Employee Stock Ownership Association Trust" company stock purchase plan, expecting to allow employees to participate in investing in the company and accumulate wealth after retirement.

Employee Benefits (Taiwan Region)

In addition to the benefits as stipulated by law, Acer also provides group life insurance, accident insurance, cancer insurance, hospital room and board insurance, and a range of outstanding employee benefits.

Practices superior to statutory standards

- Self-managed work hours**

Regular employees may adopt self-managed working hours as appropriate, provided that the quality of their services to customers is not affected.

- Sick leave with full pay**

Full pay is given to those who do not exceed 15 days of sick leave in a year.

- Annual leave for new staff**

If an employee has not completed his or her probationary period after three months of employment, his or her annual leave for the current year shall be granted in accordance with the law; and if the employee has completed his or her probationary period, he or she shall be granted seven days of annual leave until the date of completion of one year of employment.

- Advance special leave**

If an employee does not have any special leave in the current year, or if he/she has already taken all the special leave in the current year, he/she can advance the special leave in the next year, and the maximum number of days can be advanced to all the special leave days in the next year.

- Paid volunteer leave**

Staff can apply for two days of paid volunteer leave per year, with the minimum leave unit being a half-day.

- Maternity Benefits**

Acer offers employee maternity benefits, child scholarships and cooperative childcare facilities. When Acer staff are faced with the needs of parenthood, they can apply to take unpaid parental leave and, upon the completion of the leave period, return to their position. In this way, they are able to take care of their personal and familial needs.

- Employee Stock Ownership Trust**

Starting from 2022, Acer has established an Employee Stock Ownership Trust. Under the Employee Stock Ownership Trust, each employee can contribute funds from his or her salary to purchase Acer stock each month. For example, if an employee contributes NT\$1, the Company will contribute NT\$1, which is equivalent to a 50% company subsidy. Acer employees are entitled to annual dividends from the stock ownership trust while they are still employed, and their trust holdings are not disposed of until they retire. This helps employees save for retirement and retains talent. Acer expects employees to grow with the company.

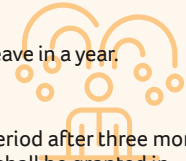



Employee Benefits offered by Taiwan Headquarters



Recreation and Entertainment Benefits

• Various activities

The Acer Welfare Committee is committed to creating a happy workplace where employees have a balanced mind and body, and to creating a positive and engaged work environment. It frequently organizes a variety of welfare activities, including family days, appreciation tours, festivals, movies, arts and culture, seminars, sports, volunteer activities, stress relief and health promotion activities, etc. In 2022, these activities had a total of over 43,000 participants.

• Integrating virtual and real activities to cater to various communities

As the COVID-19 epidemic is gradually unsealed in Taiwan, activities are held in alternating or combined form, both physically and online, so that more colleagues and family members can participate in activities in an online manner that makes them feel at ease, and secondly, they can choose to gradually resume their normal work and life rhythms through interactive exchanges with others.

• Provide e-vouchers/cash benefits to subsidize family care

We continue to provide e-vouchers and other benefits to subsidize travel, massage, leisure and entertainment, food, etc. to create a more diversified activity experience for our employees, so that they can enjoy life with their family and friends to create a balanced life between work and life.

• Advocating and implementing eco-friendly Family Day

The physical Family Day, which has been absent for 2 years due to the epidemic, resumed in 2022. The theme of the family day activity is to respond to the corporate culture initiative - Project Humanity, and to promote the company's core values - ESG, to expand the concept and action of marine conservation to colleagues and their families and friends, the theme of the activity is Clean Ocean, Green Life, and Together with the Earth. The Family Day at National Museum of Marine Science and Technology brought together 5,076 employees and family members in Keelung.

• Providing intellectual benefits to meet the needs of self-growth

Acer Digital Library has a rich collection of books, and in 2022, a new selection of listening books has been added to allow employees to read or listen to various periodicals and books to absorb new knowledge, continuously improve themselves, implement lifelong learning, and meet the balanced mental and physical development. Utilization in 2022 has reached 8,926 visits.



Fellowship Activities and Facilities:

• Encourage the establishment of clubs, provide subsidies and counseling

To allow like-minded colleagues to learn and grow together. The existing clubs include: Cycling Club, Wilderness Society, Planting Club, Yoga Club, Dance Club, Vitality Aerobics Club, Boxing Aerobics Club, Coffee Enthusiasts Club, Badminton Club, NTC Club, etc.

• Build an exclusive fitness center for employees

In order to take care of the physical and mental balance of our employees, Acer has invested in the construction of a fitness center "Acer Fitness Center" exclusively for Acer employees and has hired professional certified fitness instructors to run and manage the center. In addition to a variety of professional fitness equipment, the fitness center also has weekly group classes, including muscle training class, stretching and relaxation classes, and fat-burning aerobics classes. By providing a professional, high-standard sports space for our employees, we hope to make sports a natural part of their daily routine by shortening the distance between sports venues.

• Space for sports, recreation and leisure activities

Public space such as recreation area, dance classroom, café, recreation hall, basketball court are built for employees to use.

• Provide departmental and divisional recreational subsidies

Provide funding for colleagues to plan recreational activities flexibly and autonomously to create interaction and team cohesion.



Cash Benefits and Childcare Support Measures

• We provide Dragon Boat Festival, Mid-Autumn Festival, Spring Festival gifts and birthday gifts to take care of our employees and their families.

• We provide various kinds of cash subsidies for wedding and funeral to express congratulations or condolences.

• We provide maternity subsidies, child scholarships, cooperative childcare facilities, office chairs and reclining sofas for pregnant women to rest, and four breastfeeding rooms certified by the New Taipei City Health Bureau.

Employee Welfare at Working Locations Worldwide

• Promoting Physical and Mental Health

In order to promote the health of our employees, we organize health checks and various activities to help employees relax. For example, the Thailand office held a pedometer competition where colleagues recorded their walking or running steps through an app and the top two received prizes. The South American office is holding the Yellow September Care Campaign to encourage employees to post positive messages to colleagues on the company's internal social media platform to promote mental health.

• Providing Self-Development Courses

Business English classes are held to enhance employees' cross-country communication skills. We also offer MBA related courses to help our employees improve their workplace skills, such as marketing tools and e-commerce, accounting courses, introduction to tax law, time management, and presentation skills.

• Environmental Conservation

The European Office encourages colleagues to commute by bicycle to reduce CO₂ emissions from transportation by holding a bicycle challenge for the fourth consecutive year. The Company's IT staff builds tracking software to record the miles ridden by colleagues during the week, and the winner receives an Amazon e-gift certificate, with the number of participants increasing each year.

• Gender Equality Care

The China office presented a small gift of care to female employees on International Women's Day. The Brazil office held the Blue November Care Campaign to remind male employees to pay attention to health care and major diseases, so as to reduce the investment cost of health insurance and help men build good health knowledge.

• Team Cohesion

We send out seasonal gifts and hold caring/gathering activities in response to local festivals, e.g., the U.S. office holds an annual party to celebrate Christmas. We also hold monthly birthday parties to provide networking opportunities for our colleagues outside the workplace.

Easter gift boxes were given to employees and enjoy the holiday with their families. The Southeast Asia Office held a singing competition, where the top three scorers received prizes. The participants demonstrated their talent during the competition, which helped them gain confidence and socialization, while supporters were enthusiastic about the competition and warmed up office friendships.

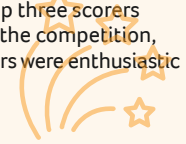

Employee Support Program

The Company offers a variety of programs to promote the health and well-being of its employees, including:

Flexible working hours

In Sweden, the start of working time is between 08:00 and 09:00 and the time of leaving the office can be between 16:30 and 18:00, depending on the individual's work or family needs; in Thailand, all full-time employees have flexible working hours. Employees can choose between two shifts: 08:30-7:30 or 09:00-18:00; in Australia, the government requires that employees with family care responsibilities, aged 55 years old or older, with disabilities, or experiencing domestic violence are eligible for flexible working hours; in Japan, employees can choose to start work between 6:00 am and 10:00 am; in Hong Kong, employees can choose to start work between 08:00 and 10:00 am; and can finish work between 17:00 and 19:00.

Work from Home

At Acer headquarters, we have activated work from home during the 2021-2022 epidemic to ensure the health of our employees while maintaining smooth day-to-day operations; globally, we have adopted work from home initiatives at each of our regional operations. For example, in the U.S., 2 days of work from home from 2021 through April 2022; in Brazil, 2 days of work from home per week; and in Mexico, 1 day of work from home.

Nursing Facilities

Nursing spaces are available in all Acer offices. For example, at Acer headquarters, we have four nursing rooms for employees. Each nursing room is equipped with a refrigerator for breastmilk, a bottle dryer and an electric breast pump for nursing mothers to use. For safety and security, all nursing rooms are equipped with an access control system and curtains in the rooms to maintain privacy. This nursing room has been awarded as an excellent nursing space by the New Taipei City Government. In addition, in California and Texas, local operating centers have set up government-regulated private spaces for breastfeeding mothers to use and provide the necessary equipment for electric breast pumps.

Relative Care Leave

In addition to parental leave, relative care leave is often implemented in local office districts. In France, to facilitate family care responsibilities, employees can apply for up to five days of family care leave in the event of a major or urgent family need (e.g., serious illness or death of a child, adopted child, parent, foster parent, grandparent, spouse/life partner, grandchild or sibling); in Australia, family care leave can be flexibly integrated into the workday. This flexible working arrangement can be requested if a relative or family member needs care or support due to domestic violence; in Singapore, employees have up to 6 days of care leave for their relatives. In addition to meeting the minimum requirements, our Pan American headquarters in San Jose, CA offers a paid family care leave policy that slightly exceeds the minimum statutory requirements. In California, state law requires that the Weekly Benefit Amount (WBA) for Paid Family Leave (PFL) be approximately 60 to 70 percent of income (depending on income) for the 5 to 18 months prior to the date of the incident. However, at Acer, the weekly benefit payment is never less than 70% of weekly earnings, which exceeds the regulatory requirement.

Paid Parental/Paternal Leave

Regarding paid parental / paternal leave for primary caregivers (such as parents), at Acer headquarters, women are entitled to eight weeks of paid maternity leave, which is in line with the Labor Standards Act. However, regardless of their length of service at Acer, the company gives full salary to the employee, which exceeds the Labor Standards Act, which only gives 50% salary for employees with less than six months of service. Acer also provides paid parental leave for non-primary caregivers and the policy at its U.S. headquarters exceeds the legal requirements. Under California law, to be eligible for Paid Family Leave (PFL), an employee must be a caregiver for a seriously ill family member, have a parent-child relationship with a newborn child, or be unable to provide effective family care due to military service. However, at our Pan American headquarters in San Jose, Acer's childcare policy is more flexible than the law. Under Acer's Paid Family Care Leave, the definition of a parent-child relationship for a newborn is based on psychological and emotional attachment, without limitations related to military service. As a result, Acer employees have a higher chance of becoming a "non-primary caregiver" and receiving PFL benefit subsidies. The subsidy is 70% of weekly earnings for a total of 8 weeks of PFL during any 12-month period, making the eligibility criteria more lenient than the legal requirements.

Childcare Facilities

The Company often contracts with kindergartens near its offices so that employees' children can attend school close to the office. For example, at Acer's headquarters, we work with a kindergarten located in the Shih Chi building, allowing employees to work upstairs and children to attend school downstairs. In addition, children are eligible for tuition discounts and receive free school bags, stationery, indoor shoes, etc. This allows employees to take care of their work and children at the same time, and reduces their financial burden.

Part-time Work

Acer employees are allowed to work part-time, which can be flexibly adjusted by local offices depending on operational conditions. For example, at our European operations headquarters, employees are allowed to spend part of their working hours on campus to improve their academic or professional skills. In addition, we have also incorporated a campus internship system, which allows them to spend a few days on campus and a few days working in the company to enhance their workplace experience.

Employee Assistance Program (EAP)

Taiwan offers the "Acer Family Care Line," Employee Assistance Program, which is available to all employees and their dependents (including spouses and their direct relatives). Employees can choose to consult with counselors by phone, face-to-face, or video, and each consultation service is 60 minutes in length. Each employee is entitled to three free consultations per year. In 2022, the "Acer Family Care Line" employee assistance program served 605 colleagues and dependents by phone/e-mail and 77 colleagues and dependents through face-to-face professional counseling, helping them to have professional counselors when they encounter problems in life/emotional/spiritual/work. The employee care area in Acer Family app provides monthly care information such as anti-epileptic skits, workplace emotion management, and self-stress awareness, providing a support system to help employees and their dependents. In 2022, the satisfaction rating of employees using the Employee Assistance Program reached 90.9 points. The feedback on the effectiveness of the talks shows that employees are more able to clarify their problems and think about them from a different perspective when facing problems, and then are willing to try to take action to improve the problems.

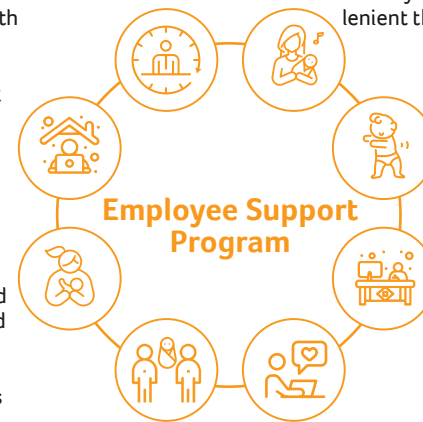

| Continuing Learning and Growth

Continuing Learning and Growth

Indicators related to GRI/SASB

404-1~3

Policies/ Commitments

Through training, development, and performance management, we strengthen the organization's ability to achieve the company's operational and ESG performance goals.

Tracking Mechanism

To ensure the quality of training, all training is conducted in accordance with the "Internal and External Training Management Regulations." The tracking mechanism includes post-class satisfaction, post-class interview, post-class action plan, and retraining (application experience sharing).

Action Plan

Through job coaching, task assignments, talent development programs, and physical and online courses, we strengthen corporate sustainability and responsibility, grasp industry trends and business opportunities, and enhance supervisors' ability to think systematically in order to continuously improve organizational effectiveness and leverage core competencies in life-style related products.

Medium- and Long-Term Goals



Medium-term goal:

To set up a flexible talent cultivation plan for each organization's strategic needs, and gradually enhance individual core competencies through career development and counseling to strengthen the succession ability of key talent in the organization.



Long-term goal:

To build a mature talent pool to be shared by all departments in the Group

2022 Goals

13.5

Continuously improve the leadership and management skills of the Group at all management levels, and continue to promote ESG-related training to strengthen the competitiveness of sustainable development; The target is to achieve an average training duration of at least 13.5 hours per employee, aiming for further growth.

Status as of 2022

13.52

In 2022, our worldwide training had 25,011 attendees, with a total number of training hours of 92,273.5. The total number of trainees was 6,821, resulting in an average training duration of 13.52 hours per employee.

2023 Goals

13.6

In response to the increasingly volatile, complex and uncertain business environment, we will strengthen the situational leadership skills of our executives and continue to strengthen the cultivation of organizational talent to lay the foundation for the ability of our succession team. The target for 2023 is to increase the average training hours per employee to at least 13.6 hours or more.

In line with the strategic development direction of the Company, the training policy for 2022 is to continue to refine the leadership and management capabilities of the Group at all levels. And we continue to promote ESG-related training in order to strengthen the competitiveness of sustainable development.

In 2022, leadership and management trainings were conducted at all management levels, with 25,011 employees trained worldwide in 2022, for a total of 92,273.5 training hours, with 6,821 employees trained and an average of 13.52 training hours per employee (exceeding the target of 13.5 hours). The average training cost per person is US\$194.3. All training organized on the principles of work demand, gender equality, and equality of opportunity.

In response to the increasingly complex and uncertain business environment, we will strengthen the situational leadership skills of our executives and continue to strengthen the cultivation of organizational talent to lay the foundation for the ability of our succession team. The average number of training hours per employee is estimated to grow to at least 13.6 hours by 2023.

2022 The Average Training Hours per Employees per year, by Gender and Employee Category

	Senior Management (Supervisor of Business unit)		Mid-level / Junior Supervisor (Division / Department Head)		General Staff	
	Female	Male	Female	Male	Female	Male
Taiwan						
Number of Trainees	47	183	903	2,031	2,550	4,520
Course Hours	162	592	3,316	7,335	11,560	14,881
Participants	11	37	167	358	741	950
Average Hours of Training Per Person	16		20		16	
EMEA						
Number of Trainees	6	53	209	487	988	2,343
Course Hours	98	567	1,259	3,530	4,652	10,797
Participants	2	19	94	223	496	1,205
Average Hours of Training Per Person	32		15		9	
Pan Asia Pacific						
Number of Trainees	3	28	333	667	1,569	2,652
Course Hours	12	313	1,471	2,836	6,568	9,053
Participants	2	10	84	179	477	686
Average Hours of Training Per Person	27		16		13	
Pan America						
Number of Trainees	9	25	115	202	706	1,013
Course Hours	122	175	463	778	2,101	3,177
Participants	5	11	44	65	210	303
Average Hours of Training Per Person	19		11		10	
China						
Number of Trainees	- ^{Note}	19	201	430	733	986
Course Hours	-	43	468	1,022	2,039	2,889
Participants	-	2	28	60	144	208
Average Hours of Training Per Person	22		17		14	

Note: The senior executive of China region is currently served by the senior executive of headquarters



2022 Supervisor Training Camp (Learning Reflection Activity)



Project Management Training - Case Discussion



Emergency Personnel Training—Practical Test



2022 Average Number of Training hours per Employee per Year, and the Average Training Investment per Person by Age Group

(Unit: US\$)

	Under 30		30-50		50 and Over	
	Female	Male	Female	Male	Female	Male
Taiwan						
Number of Trainees	397	323	3,301	4,876	802	1,535
Course Hours	1,443	1,243	11,015	16,574	2,579	4,990
Participants	101	70	661	978	157	297
Average Hours of Training Per Person	16		17		17	
Amount Invested in Training	15,301	14,331	124,990	214,489	26,961	57,518
Average Amount Invested in Training Per Person	173		207		186	
EMEA						
Number of Trainees	173	535	819	1,850	211	498
Course Hours	772	2,276	4,168	9,990	1,070	2,628
Participants	93	302	397	907	102	238
Average Hours of Training Per Person	8		11		11	
Amount Invested in Training	14,343	31,141	72,938	154,523	15,494	35,946
Average Amount Invested in Training Per Person	115		174		151	
Pan Asia Pacific						
Number of Trainees	254	272	1,443	2,670	208	405
Course Hours	1,138	1,086	6,044	9,554	869	1,563
Participants	92	105	407	638	64	132
Average Hours of Training Per Person	11		15		12	
Amount Invested in Training	13,612	11,767	73,496	151,975	12,051	16,775
Average Amount Invested in Training Per Person	129		216		147	

	Under 30		30-50		50 and Over	
	Female	Male	Female	Male	Female	Male
Pan America						
Number of Trainees	127	234	385	582	318	424
Course Hours	467	679	1,217	2,146	1,002	1,305
Participants	40	63	115	186	104	130
Average Hours of Training Per Person	11		11		10	
Amount Invested in Training	14,614	23,384	32,485	43,497	15,650	21,990
Average Amount Invested in Training Per Person	369		252		161	
China						
Number of Trainees	80	63	825	1,261	29	111
Course Hours	226	178	2,196	3,504	85	272
Participants	15	14	149	238	8	18
Average Hours of Training Per Person	14		15		14	
Amount Invested in Training	3,860	2,970	40,450	61,970	1,410	5,390
Average Amount Invested in Training Per Person	236		265		262	

2022 Average Number of Hours of Training per Person and Average Amount of Training Investment per Person by Mandatory and Elective Courses

(Unit: US\$)

	Mandatory	Elective	Mandatory	Elective	Mandatory	Elective	Mandatory	Elective	Mandatory	Elective
	Taiwan		EMEA		PanAsia Pacific		Pan America		China	
Number of Trainees	10,526	708	3,808	278	4,866	386	1,574	496	2,369	Note: China Operations Headquarters training in 2022 is mainly mandatory courses, no elective courses is offered.
Course Hours	35,619	2,224	14,496	6,407	17,721	2,532	5,720	1,096	6,460	
Participants	2,253	11	1,924	115	1,421	17	616	22	442	
Average Hours of Training Per Person	16	202	8	56	12	149	9	50	15	
Training Investment	441,415	12,175	188,698	135,687	236,904	42,772	71,188	80,432	116,050	
Average Amount Spent Per FTE on Training and Development Programs	196	1,107	98	1,180	167	2,516	116	3,656	263	



Acer Training System

Senior Management

- Titan Private Training and IPO Series Training

Middle Management

- Management Leadership Training (Middle Management)
 - Building Vision Executing Strategies
 - Inspiring Trust Tapping Potential
- Systematic Thinking on Performance Talent Management
- Prevention of Workplace Malpractice (Supervisor)

Base-level Management

- Management Training Camp (Base-level Management)
 - Stage One
 - Management Communication
 - Performance Coaching
 - Performance Management Methods
 - Stage Two
 - Targeting Talent
 - Setting Goals
 - Motivating and Retaining
- Systematic Thinking on Performance Talent Management
- Prevention of Workplace Malpractice (Supervisor)

General Staff

- ESG training
 - Standards of Integrity Management and Business Conduct
 - Information Security Education and Training
 - Response to the GDPR
- Project Manager
- Excel - Produce Business Intelligence (BI) analysis reports

New Staff

- New Staff Onboarding
- New Staff Training

Training Management Flow Chart

Management Training

- **Base-level Management Skills Development:**

To strengthen the core management skills of our base-level managers, training camps have been held regularly. As of 2022, a total of 11 had been held. This training is divided into two stages. The first emphasizes good management communication, performance coaching, and performance management, aiming to improve both team and individual performance as well as facilitating the joint creation of value; Stage 2 assists supervisors to specialize in the areas of target selection, goal setting, motivation and retention, and performance appraisal.
- **Middle- and Senior Management Leadership Skills Development**

Assist mid- to senior-level executives to enhance their leadership skills and develop them at the strategic thinking level, i.e., the 4 Essential Roles of Leadership, including how to build vision, inspire trust, execute strategy, and unleash potential. After the classroom training, online learning and experience sharing (retraining method) will be provided to internalize the growth of management skills through multiple opportunities for reflection. By the end of 2019-2022, a total of 5 had been held.
- **Senior Management Skills Development**

Expanding on the spirit of the New Titan Project and its commitment to cultivating leadership for the group, we assist vital leadership talent in boosting corporate governance, business judgment, and management skills. The focus of training in 2022 was on training senior management in how to deal with the media, how to handle PR skillfully, and how to manage crises. In addition, in order to promote the spirit of the Philosophy of WANDAO (value creation, balance of interests, and sustainable management), senior executives were sent to attend the "Philosophy of WANDAO Forum - Altruistic Thinking and Social Responsibility" to learn how to implement the spirit of WANDAO in corporate social responsibility and sustainable management.
- **Company-wide cross-level management training - Systematic thinking on performance and talent management**

With the changing business environment, the issue of talent management is becoming more and more complicated. In order to help supervisors at all levels to do a good job in performance appraisal and performance communication, we will hold "Systematic Thinking on Performance and Talent Management" (A total of 10 sessions) in 2021 -2022. After this training on performance management, supervisors will have a more thorough consideration on performance communication, performance ranking and grading, so that "talent motivation" and "talent management" can complement each other and play a more positive and integrated effect.

Professional Occupational Training

In response to the trend of lifestyle-related products, we are strengthening the core skills of our staff in the Information Products, Digital Display, and Value Innovation Center through internal and external training and technical seminars. In addition, we continue to enhance the professional knowledge of our staff in marketing, strategic operations, and back office.

The main highlights of occupational training in 2022 included:



AI Smart Manufacturing

Collaborated with Taiwan AI Academy to help product line managers understand how to use AI technology in process control, maintenance, and supply chain management, and to gain practical experience through hands-on and on-site visits. After the class, we will help the supervisors to apply what they have learned to improve the data sharing platform, supply chain, and product design verification process.



"Docker Containers and Kubernetes System Management" training

Assist software teams to understand how to effectively handle the rapidly increasing number of software application services through decentralized architecture and serverless technology to enable faster and more stable software iteration and operation of life-style products.



General Education Training

General education courses in 2022 covered the following three key points:



ESG-related training

We are actively promoting training related to the Standards of Integrity Management and Business Conduct (SBC), such as information security awareness, personal data protection, and the SBC module for newcomer training, in all regions of the world, with 100% implementation. In 2022, 15,492 training sessions and 57,038 training hours have been completed in relation to this theme.



Project Management Skills Enhancement Training

Strengthening staff's project planning, interdepartmental project communication and coordination, and project schedule control capabilities, and thus improving project execution quality and performance. This includes understanding project decomposition techniques (WBS), critical path (CPM), program evaluation techniques (PERT), project risk management, delay response techniques, project schedule shortening techniques, and agile management (Scrum).



Information Analysis

Help colleagues understand how to quickly create business intelligence analysis reports through Power BI technology, quickly integrate scattered data tables, and produce dynamic visual reports to improve the efficiency of business development, statistical forecasting, and sales analysis.

New Staff Training

Since the new employees joined the company, the company has provided a series of orientation and training to help them understand the Company's profile, management system, corporate core values, and brand spirit.

Each department also provides short-term professional training for new employees to understand the duties of the department, organizational members, upstream and downstream operational processes, and the points to note for cross-department collaboration.

For example, the overall PC operation process training held by the IT product department is to guide newcomers to understand the product development process, from product development, product hardware and software expertise, supply chain, quality assurance, manufacturing, branding, market analysis methods and other overall concepts.

In addition, each department assigns a mentor to each new employee to provide consultation and care for adaptation at any time, so that new employees can adapt to the environment faster and integrate into the team faster.

ESG-related training is also arranged, such as Standards of Integrity Management and Business Conduct (including promotion of labor rights, freedom of expression, personal privacy, prevention of sexual harassment, anti-corruption), and reinforcement of safety and health concepts. We also listed actively encourage staff to take training in CPR and automated external defibrillator use.

Training Focus of Each Operating HQ

EMEA Headquarters		Pan Asia Pacific Headquarters	
<ul style="list-style-type: none"> • Refine professional competence Courses in finance, marketing, human resources, lean management, business negotiation, etc., for example: Lean Management Training Successful Negotiating for Advanced Learners • Promote internal knowledge transfer Training of Trainers Realization of Teaching-Learning Processes at the Workplace • Improve management training at all levels EMEA Aspiring and Inspiring Managers Coaching Program Leadership Skills for Team Leaders 	<ul style="list-style-type: none"> • Enhance language communication skills English-- Individual / Group Training French Language Development • Staff representative training Training for Works Councils • Promote workplace health, safety, and harassment prevention First Aid Course Health Prevention at Work • Enhance data processing training Power BI 	<ul style="list-style-type: none"> • Enhancement of key training for all levels of management Training & Coaching Program: The Future Leader Data Analytics for Managers • Develop problem analysis and resolution skills Critical Thinking and Problem Solving Stress-free Performance & Productivity • Enhancement of fast data processing capability Excel- Intermediate & Advanced level 	<ul style="list-style-type: none"> • Enhancement of professional capacity The most representative courses are Digital Marketing Training - 2 days Training in Acer Thailand, Product Training: Key Differentiator for Competitive Advantages, Sales Pitch - Your Primary Tool • Promote workplace health, safety and DEI training Occupational First Aid Refresher Course Diversity Communication at Workplace • Motivate self-growth Leading Yourself to Success
Pan American Headquarters		China Region Headquarters	
<ul style="list-style-type: none"> • Enhance the e-commerce capability of senior management Live University - MBA e-Commerce MBA in Marketing and Digital Business Intelligence • Enhance the professional ability of each unit Cloud Tech: AWS Discovery Day Customer Services: Customer Interactions 	<ul style="list-style-type: none"> • Enhance e-commerce capabilities E-Commerce Optimization and Operation Training (including e-commerce operation training camp (including e-commerce operation full chain interpretation, platform traffic operation-search optimization interpretation, platform traffic operation-through the optimization strategy, store all-dimensional internal skills to build and improve, e-commerce platform customer service training)) • Management Training Work-from-Home for Managers Training 		

Highlight Training: "2022 e-Commerce Optimization and Operation Training Camp" (China Operation Headquarters)

Goals

The training is designed to strengthen the e-commerce knowledge of the China operation headquarters staff, develop core marketing skills, and familiarize them with the Company's products and basic marketing tools and techniques to increase profitability through efficient e-commerce services and sales methods.

Approach

Through training, all e-commerce employees in the consumer and commercial business units are required to attend 20 hours of training on e-commerce operations.

- E-commerce operations full chain of interpretation (2 hours)
- Platform Traffic Operation - SEO Explanation (2 hours)
- Platform Traffic Operation and Paid Promotion - Optimization Strategies for Jingjun Pass Placement (2 hours)
- Jingdong store all-dimensional internal skills to build and improve (2 hours)
- Customer service training (2 hours)
- Platform 2022 11.11 promotion operation whole process planning & interpretation (8 hours)
- Jingdong Digital Square computer category application training (2 hours)

During the training, the instructor explained the necessary e-commerce skills in the process of cooperation between Acer and Jingdong, especially the overall e-commerce marketing strategy, the latest marketing tools, the service model, the basic operation planning and rules of Jingdong stores, and let colleagues learn the search engine optimization (SEO) rules to enhance the operational effectiveness.

Training Efficiency

During the training process of e-commerce, the trainees have understood the essence of Acer's operation in cooperation with Jingdong. In the simulation project, students will be able to grasp the relevant e-commerce practices in more detail and improve the existing e-commerce operation management more precisely, laying down the key success factors for future operation.

Effect

• Training Satisfaction, Learning and Application.

The training score is 4.5 (out of 5). The course participants generally believe that the non-business colleagues understand the needs of the front-end business colleagues more fully, and the business colleagues can better integrate e-commerce knowledge with the practice. It is therefore improve the Company's performance, and also significantly improve their personal e-commerce knowledge, ability, and experience.

• Benefiting from the knowledge and skills of e-commerce operations in this training.

The China Operation reached a new high in e-commerce transactions during the 618 Shopping Festival in 2022, with annual channel-wide growth of more than 50%; and continued to maintain channel-wide growth of more than 10% and significantly outperformed the general market during the Double Eleven in 2022.



Performance Management and Development

The goal of Acer's performance management and development system is to improve performance at individual, departmental and organizational levels, and includes goal setting, delegation, communication & coaching, the link between performance & remuneration, and career development. In 2022, the proportion of employees worldwide involved in performance evaluations reached 94%. Starting in 2022, the Global Employee Performance Review incorporates SBC, which require supervisors to assess performance while also considering employees commitment to conducting business legally, ethically and with integrity.

Type of Performance Evaluation	Percentage of all employees
Management by objectives: Systematic use of measurable goals agreed upon by the line manager	94%
Multidimensional performance appraisal (e.g., 360-degree feedback)	2%
Official comparative ranking within the same employee category	94%

Note: The number of participants of Multiple Dimension is 89.

Proportion of Employees Worldwide Involved in Performance Appraisal, 2022

	Staff Receiving Performance Appraisals (A)		Total Number of Staff Who Must Take the Performance Appraisal (B)		Performance Participation Rate		Overall Performance Participation Rate (A) / (B)
	Female	Male	Female	Male	Female	Male	
Technical Staff	540	1,427	582	1,532	92%	93%	93%
Specialist Staff	792	864	826	924	96%	94%	95%
Management Staff	350	772	379	832	92%	93%	93%
Administrative Staff	353	262	370	272	95%	96%	96%

Note 1: Short-term (one year or less) hires and those with short working hours can be difficult to track the effectiveness of, working and therefore are not included in the appraisals.

Note 2: Those hired since October and are examined at the completion of that period and as such are not subject to the same performance appraisal.

Note 3: AOpen, Weblink, ACSI, Acer Synergy Tech, and ISU IPO companies are not included in the appraisal.

Note 4: The evaluation period is 2023Q1, and the total number of current employees who must be evaluated during the evaluation period is captured.

Note 5: The number of employees undergoing performance evaluation is the number of employees who have completed self-evaluation operations or supervisors have completed evaluation operations at the end of March 2023.

Health and Safety in the Workplace

Occupational Health and Safety

Indicators related to GRI/SASB

GRI 403

Policies/ Commitments

We recognize that the safety and health of our employees is the foundation of our business operations and are committed to maintaining a healthy and safe work environment to safeguard the physical and mental health of our workers and to reduce occupational safety and health risks.

Tracking Mechanism

- Introduced ISO 45001 occupational safety and health management system to maintain system effectiveness through full employee participation and internal and external audits.
- The Occupational Safety and Health Committee is convened quarterly to track management goals and improve occupational safety and health performance.

Action Plan

- Promote group-based occupational safety and health management and establish a tracking and checking mechanism.
- Implement contractor management, requiring compliance with regulations and Acer's environmental safety and health policies.
- Produce safety and health e-Learning materials.
- Implement graded management of health inspection reports and regularly tracked abnormal cases.
- Organize 6 health seminars based on the analysis of health check reports and encourage employees with health check abnormalities to attend.

Stakeholder Engagement and effectiveness

- Join OSHA's Workplace Health and Safety Sustainability Dialogue Platform and Partnerships to strengthen sustainable workplace health and safety practices.
- Participate in healthy workplace certification to maintain health and safety performance.
- Participate in sports enterprise certification to continuously promote sports culture.

Medium- and Long-Term Goals

90% Acer Taiwan Occupational Safety and Health Management System has a coverage rate of over 90%

Acquire Health Promotion Administration Healthy Workplaces Excellence certification.

2022 Goals

ISO 45001 Assist the subsidiary to complete ISO 45001 system procedure documents for our subsidiary.

75% Develop Safety and Health e-Learning course, 75% of employees completed the course.

0 No major occupational accidents (excluding traffic accidents).

0 No occupational hazards in the workplace.

90% Optimize employee health check program, 90% of employees participated.

Status as of 2022

3 A total of 3 subsidiaries have completed the ISO 45001 system procedure document.

84% Complete Safety and Health e-Learning course 2, 84.3% of employees completed the course.

0 No major occupational accidents (excluding traffic accidents).

7 This year, there were 7 occupational accidents at workplaces, with a loss of 7.5 working days.

85% Employee health check include 3-choice 1 optional sets. Due to the epidemic restriction, 85% of employees participated.

2023 Goals

3 3 subsidiaries operate ISO 45001 management systems independently and pass external audits.

87% Raise awareness of safety and health, 87% of employees will complete e-Learning courses.

0 No major occupational accidents (excluding traffic accidents).

3% The rate of employee inspection abnormalities will be reduced by 3% compared to 2022.

10% Attendance at health care seminars will be increased by 10% compared to 2022.

Promotion of Occupational Safety and Health Management System

In order to comply with legal regulations and to continuously improve health and safety performance, Acer Taiwan conducts annual ISO 45001 management system certification, which covers Xizhi headquarters (including subsidiaries whose offices are within the headquarters) and all office locations. In addition, six subsidiaries, including ACSI, Acer eDC, AEB, Acer Synergy Tech, HTC, and HSN, also participated in the certification independently.

In order to implement the system management, each company sets up various safety and health management personnel, and at the same time establishes an Environmental Safety and Health (ESH) working group to promote various operations in accordance with the plan-do-check-act management model, and ensures the effective operation of the system through an external certification mechanism every year.

For non-certified subsidiaries, although the office environment and operations are low risk business units, we have established a verification and counseling mechanism to ensure the safety and health of workers to ensure compliance.

Acer Taiwan Occupational Safety and Health Management Path

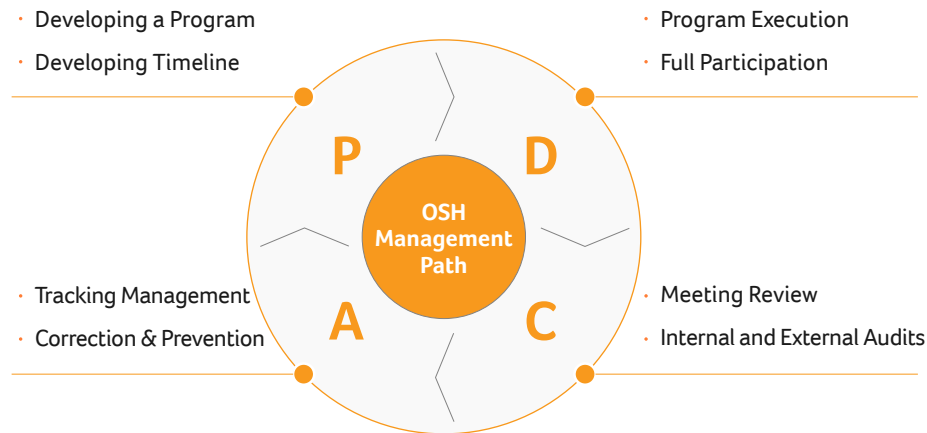

Acer Taiwan 2022 Occupational Safety and Health Management System - Major Investments and Implementation Results

Item	Actions	Effects
P Health and Safety Management Program	Develops a health and safety operations management plan operations and reviews it annually.	Managed a total of ten projects
P Health and Safety Operating Standards	Health and safety operating standards documentation has been set up and is reviewed every year.	A total of 30 procedure documents are in management
D Hazard Identification and Risk Assessment	Each year, we conduct a five-level risk assessment of all workers' activities and service areas in the organization, and propose management plans to track and improve high-risk items at levels 4 and 5.	A total of 1,670 items have been assessed, no level 4 or 5 items found
D Regulatory Identification	Periodically identify the applicability of and compliance with changes in occupational safety-related laws and regulations.	A total of 29 regulations were identified and managed
D Management of Chemicals	Use of formaldehyde, cleaning naphtha, and leaded solder prohibited.	No non-compliance was found in internal or external audits this year
D Health and Safety Education and Training	With health and safety personnel in place, a range of health and safety education and training is carried out.	Organize three types of training, including ambulance, security and firefighting
D Health and Safety Promotion	We promote through channels such as meetings, bulletin boards, restroom literature, internal websites, emails.	Content includes: Health education, infectious disease prevention, traffic safety, workplace safety, occupational accident investigation, and more
D Emergency Response Management	Drills are carried out in line with the annual plan covering fire, earthquakes, typhoons, power outages, and emergency rescue.	A total of 7 drills were held
D Outsourcing Management	Annual audit of resident/regular outsourcing contracts and renovation project management	A total of 18 outsourcing contractors were audited
C Operating Environment Monitoring	Drinking water quality, indoor carbon dioxide, air conditioning cooling water tower veteran's bacterium detection; formaldehyde, TVOC, PM10, PM2.5 detection after completion of large renovation projects	Test results were in line with standards. Test results were published on internal website.
C Automated Inspections	Automated inspections of equipment are conducted regularly.	Completed according to annual plan. Records kept in each office.
C Internal and External Auditing	Annual internal and external audits are conducted to ensure ISO 45001 certification.	28 internal audits and 4 external audits were completed, with all necessary improvements completed
A Accident Investigation	Investigate and report on accidents and develop corrective/preventive measures.	There were 32 accidents in total, see accident statistics for 2022

Acer Taiwan Occupational Safety and Health Management System Certification Coverage Rate

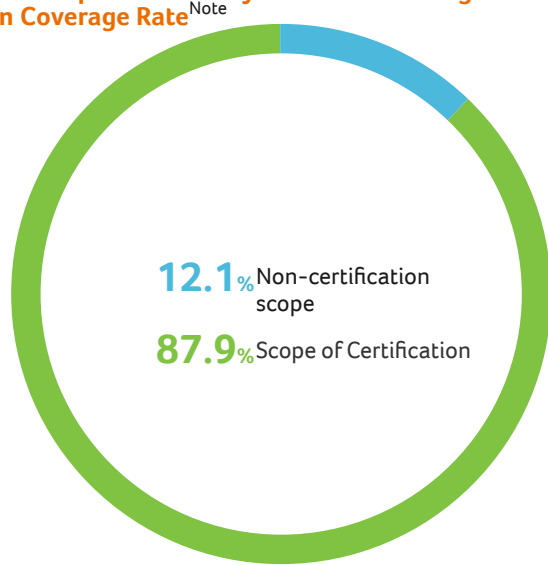

Note 1: Acer Taiwan's Occupational Safety and Health Management System (OSHMS) certification covers 2,876 employed workers and 202 non-employed workers in workplaces. The percentage of non-employed workers is about 6.6%.

Note 2: A total of 12.13% of the total number of companies in Acer Taiwan, including Weblink, Acer ITS, Acer Being Communication, Acer Beverages, Aspire, Acer Asset Management, and Keypack have not been introduced to the Occupational Safety and Health Management System certification.

Note 3: Acer is a branded company, and its products are OEM (Original Design Manufacturer). It has an assembly plant in Taoyuan, Taiwan, which is covered by the headquarters' occupational safety and health management system. The overseas branches are low-risk offices and have not yet been validated for management systems.

Acer Taiwan Safety and Health Management Staff Statistics (Unit: Person)

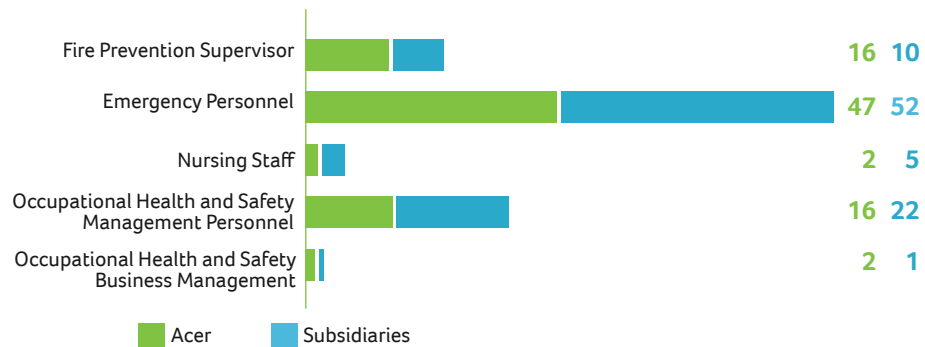

Implementation of Safety and Health Supervision and Management

To ensure that safety and health are effectively managed and monitored, we encourage employees to call our internal 1911 service line immediately if they find any safety and health issues in the workplace that could affect them. At the same time, employees can use the labor-management meeting to propose safety and health improvement suggestions, and the responsible department will evaluate and respond to the proposals according to their content. In addition, the ESH Team conducts an annual hazard assessment of the activities and service areas of all workers in the organization. At the same time, ESH Team conducts risk and opportunity assessment by investigating the needs and expectations of stakeholders. The ESH Team also sets management objectives for high-risk and high-opportunity items and propose a management plan, and track the implementation progress through regular meetings on a quarterly basis. In 2022, a total of nine safety and health management goals have been set, including the optimization of employee health check programs.

We take every accident in the workplace seriously. When an accident is reported, we provide health care to the injured employee, initiate investigation with labor representatives, develop corrective measures and conduct internal promotion to prevent recurrence of the accident. Although traffic accidents that occur during commuting are not included in the occupational accident statistics, we keep track of them because they are the main type of accidents. Statistics 2022 Acer Taiwan had 32 accidents, 25 of which were commuter traffic accidents, accounting for 78.1%. The remaining categories were: 5 falls, 1 burn, and 1 crash.

Hazard Identification and Risk Assessment



Risk and Opportunity Assessment

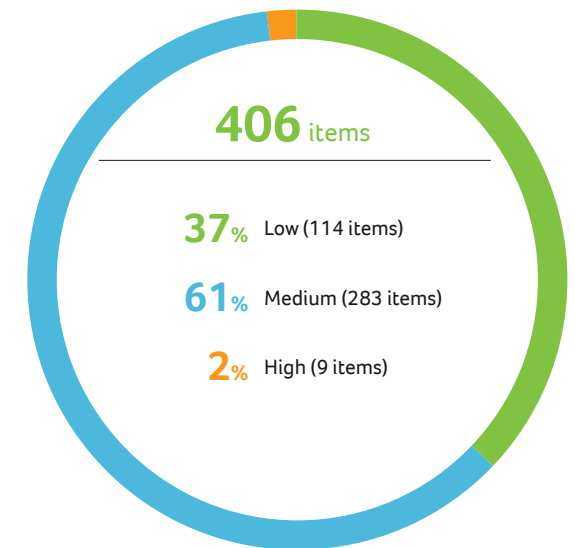



Acer Global Work-Related Injuries Statistics 2022

	Full Time		Non-full Time	
	Female	Male	Female	Male
Number of Fatalities	0	0	0	0
Rate of fatalities as a result of work-related injury	0	0	0	0
Number of high-consequence work-related injuries	0	0	0	0
Number of days lost to high-consequence work-related injuries	0	0	0	0
Rate of high-consequence work-related injuries	0	0	0	0
Number of recordable work-related injuries	7	7	0	5
Number of recordable work-related injuries loss days	33	80.5	0	95
Rate of recordable work-related injuries	0.24	0.15	0	2.88
Number of cases of work-related ill health	1	2	0	0

Note 1: The above statistics cover Taiwan, EMEA, Pan-Asian, Pan-American, and China regions. Traffic accidents to and from work are not included.

Note 2: Definition of each category:

- Rate of fatalities as a result of work-related injury: (number of work-related injury fatalities/hours worked) * 200,000
- High-consequence work-related injuries: Injuries resulting from work-related injuries that make it difficult for workers to return to their pre-injury state of health within six months
- Rate of high-consequence work-related injuries: (number of high-consequence work-related injuries (excluding fatalities)/hours worked)*200,000
- Number of recordable work-related injuries: net of fatalities and serious occupational injuries
- Rate of recordable work-related injuries: (number of recordable work-related injuries/hours worked)*200,000
- Number of cases of work-related ill health: must be approved by medical institutions.

Note 3: Working hours: Since our offices are located in many countries around the world, for the sake of consistency, the calculation is based on 248 working days in Taiwan * 8 hours of work per day * total number of people in each location.

Note 4: Three cases of work-related ill health are from EMEA.

Acer Global 2022 Occupational Injury Category



Strengthening Safety and Health Participation and Awareness

We believe that in order to build a safe and hygienic workplace culture, it is essential to strengthen the safety and hygiene awareness of workers. We disseminate safety and health information through multiple channels such as internal and external meetings, education training, health education, and health promotion activities to raise employees' awareness of safety and health. We remind the staff that if they encounter hazards in the workplace, their own safety should be their first priority and they should notify the responsible unit afterwards.

According to the statistics, in 2022, there will be a total of three types of training, including ambulance, security and fire fighting, with an overall satisfaction rating of 4.5 points or more.

We also value the participation, consultation and communication of workers. Acer Taiwan has set up an Occupational Safety and Health Committee, which meets quarterly to review and discuss related business activities. In order to enable employees to understand the safety and health management practices and results, we have set up an internal safety and health website and information platform, and at the same time, we are able to communicate with workers immediately in response and feedback to build mutual consensus.



2022 Health and Safety Education and Training



Emergency Personnel

On-the-job training **62** people **4.6** points

Emergency Rescue Drill

1 session **51** people **4.1** points

CPR+AED

1 session **21** people **4.95** points

First-aid training



Safety and Health Management Personnel

On-the-job training **17** people

Training for new employees

6 sessions **4.75** points

e Learning

Chapter 2 **1,719** people **84.3%**

Health and Safety Training



Fire Prevention Supervisor

On-the-job training **3** people

Fire Prevention Seminar

1 session **79** people **4.85** points

Fire Prevention Training

Acer Occupational Safety and Health Committee Organization Chart

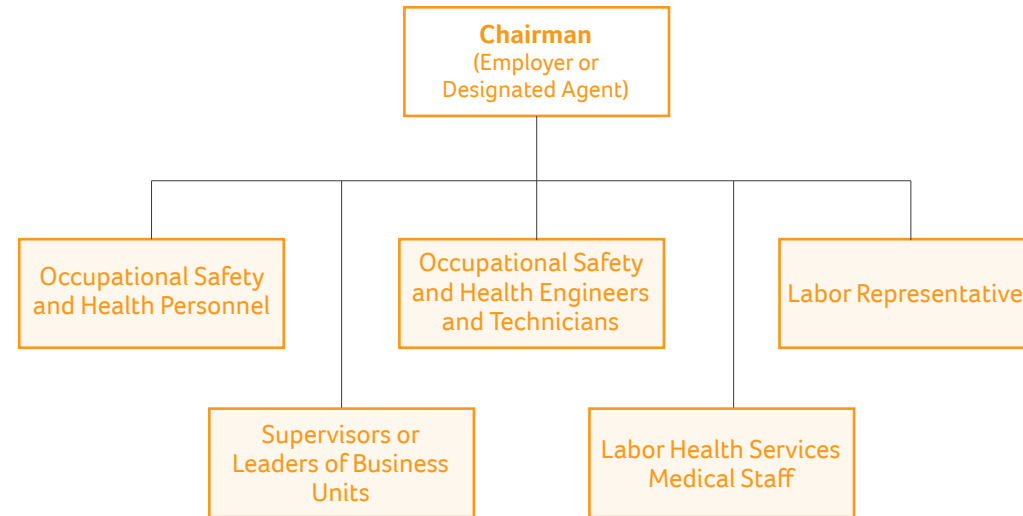

Note: The Occupational Safety and Health Committee consists of 36 members, of which 25 are labor representatives, accounting for 70%.

Constructing a Healthy Workplace Culture

We believe that the health of our employees is a key indicator of corporate sustainability, and Acer Taiwan has dedicated and contracted medical staff to implement health protection programs through annual health check, health management, health promotion, and occupational injury and illness prevention to protect the health of our employees. At the same time, we combine the resources of the Employee Relations Department, the Welfare Committee, the Fitness Center and other departments to organize a variety of physical and mental health care activities to strengthen employees' attention to health and build a healthy workplace culture.

In 2022, in order to demonstrate the importance of employee health, the company increased the budget for health checks. After analyzing the health check reports of our employees, we discussed with the occupational physicians and added three optional items to the health check, so that employees can choose the appropriate plan according to their health conditions.

In order to help colleagues understand the content of health checkup and increase their willingness to do so, we designed a lively animated video to facilitate interactive discussions among colleagues. However, due to the impact of the Work at Home (WFH) epidemic, the overall employee health check rate in 2022 decreased compared to the previous year, but the overall satisfaction rating improved to 4.7, showing that employees are positive about health checkup activities and continue to take personal health issues seriously.



Key Elements of Health Protection Program Implementation

2022 Health Check Rate



Occupational Injury and Disease Prevention Management Statistics 2022

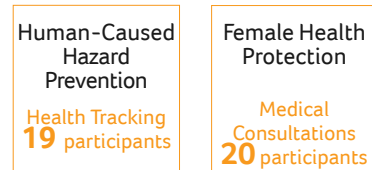
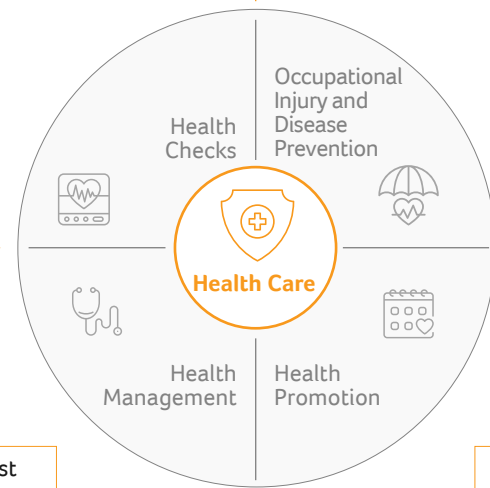
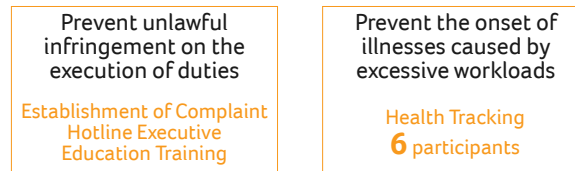

Health Management Statistics 2022



Health Promotion Statistics 2022

Occupational Health and Safety Management for Outsourced Contractor

In order to comply with the Occupational Safety and Health Act and the management system requirements for contracting, Acer conducts annual audits of resident and regular contracting; to strengthen outsourced contractors' knowledge of occupational safety and health, we design educational training courses that include pictures, videos, and tests for online learning. We also conduct project contract management for higher risk renovation projects to prevent occupational hazards for contracted personnel at Acer operation sites. At the same time, in order to strengthen the safety and health management of contractors, we share relevant safety and health information from time to time, and we hope that we can work together to build a safe working environment for workers through the dissemination of knowledge and the improvement of awareness. In 2022, there were no accidents involving outsourced contractors in the workplace.

Basic Requirements	Management Method
Resident Contracts / Normal Contracts	
<ul style="list-style-type: none"> • Labor Insurance • Health Checks • Complete Health and Safety Education and Training 	<ul style="list-style-type: none"> • Notification of Workplace Environmental and Hazard Factors • Dissemination of Health and Safety Work Regulations • Occupational Safety and Health Pledges
Renovation Project Contracts	
<ul style="list-style-type: none"> • Labor and Engineering Insurance • Before operation: Implement safety checkpoints and conduct health and safety promotion • During operation: Carrying out supervision and management • After operation: Conduct thorough inspection • Special requirement: Work generating noise or odors will be undertaken during non-working hours 	<ul style="list-style-type: none"> • Notification of Workplace Environmental and Hazard Factors • Construction Safety Standards and Precautions • Contractor Environmental Health and Safety Management System • Pre-entry Health and Safety Information and Records • On-site Supervision and Inspection 



Digital Inclusion and Social Philanthropy

Digital Inclusion and Social Philanthropy

Indicators related to GRI/SASB
GRI 201-1, 203-2

Policies and Commitments

We focus on education, environmental conservation and public charity as the three main axis of social care. We combine the various volunteer services of our employees and provide products, technology, money and human resources to participate in community affairs and charity activities.

Action Plan

- Acer Foundation implements various projects
- Acer volunteer teams carry out social welfare activities
- Acer subsidiaries around the world conduct culturally and environmentally relevant activities

Tracking Mechanism

- Acer Foundation holds annual board and supervisory meetings to review performance.
- Acer Volunteer Teams hold regular volunteer team meetings every year to review performance.
- Each Acer subsidiary submits project results to the regional headquarters to review the performance of their projects, and the regional headquarters submit the top five to the ESG office to understand the performance results.

Management Processes

- The Acer Foundation proposes annual project plans and goals, and holds regular meetings of the Board of Directors and Supervisors to review performance.
- Acer volunteer team proposes the planning and goals of each project, and holds regular volunteer team meetings every year to review the performance of implementation.
- Each year, Acer's global subsidiaries propose project plans and submit the project results to each regional headquarters for review of implementation performance, and the regional headquarters submit the top five to the ESG office for understanding the implementation results.

Stakeholder Engagement and Effectiveness

Acer's global digital inclusion and social good projects are conducted in detailed communication with various stakeholder groups to ensure that the projects meet Acer's objectives and stakeholder needs.

Medium- and Long-Term Goals



Continue implementing care for the elderly and children, responding to the needs of society

2022 Goals

15

The New Year's Eve dish delivery event is organized for the elderly who live alone in Xizhi, Shengkeng and Shiding. 15 drivers are expected to be recruited.



To care for underprivileged children, we invited our colleagues to donate Christmas gifts to children in local social welfare units in Xizhi.

Status as of 2022

63

New Year's Eve dinner for the elderly: 63 volunteers were recruited and 28 staff members and 35 family members and friends formed this volunteer team, with 18 of them serving as drivers.



Christmas Gift Collection: The project's input efficiency status is evaluated and canceled.

2023 Goals



Global subsidiaries focus on education and environmental projects through ESG Project Awards



Ideas and Inputs

By incorporating the corporate spirit of "breaking barriers between technology and people" into the concept of social engagement, Acer Group has been able to leverage its expertise and core competencies to contribute to the company's efforts, thus embedding the mindset of sustainability and action in the company's culture; enhancing employees' sense of identification with Acer; and sharing success stories with global partners, suppliers and investors to expand social impact. We consider the needs of the local community, combine the volunteer services of our employees, and provide products, technology, money, and human resources to participate in community affairs and charitable activities. In 2022, Acer Group's total contribution to social engagement activities worldwide was approximately NT\$39,142,120, accounting for approximately 0.8% of the Company's earnings.

Social Impact of Acer's Global ESG Projects

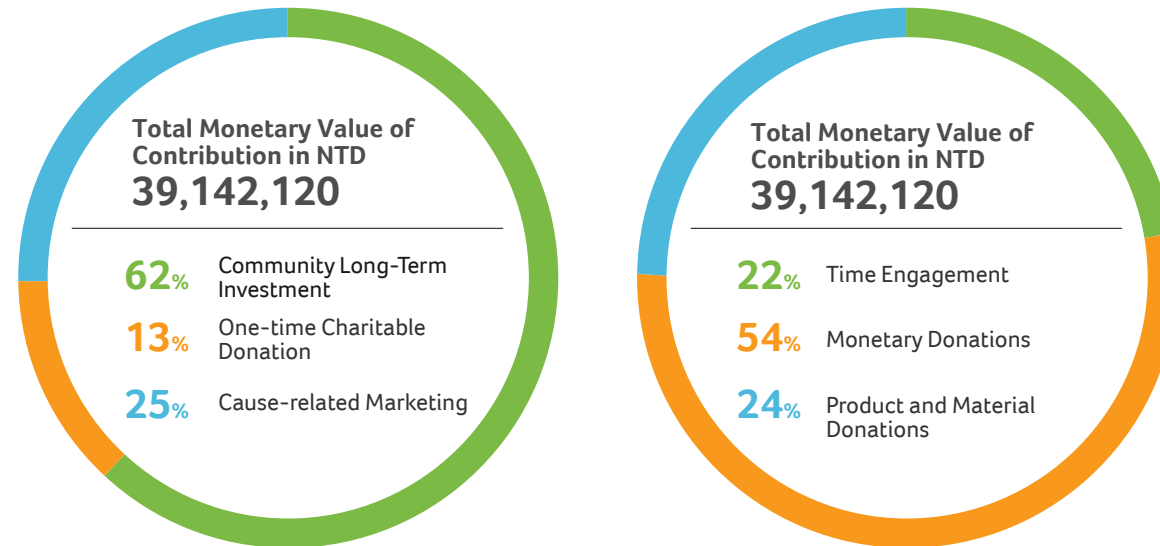

Note 1: Based on Central Bank's closing rate of US\$1=NT\$30.98 on 12/31/2022

Note 2: Data and overall statistics for the various ESG Projects in 2022 are provided by Acer's global subsidiaries

Note 3: Total monetary value of all contributions is converted from cash, products, manpower input, including: NT\$5,068,433 for one-time charitable donations, NT\$9,811,821 for cause-related marketing, NT\$24,261,866 for long-term community investments

ESG Project Awards

The Acer Group operates in more than 160 countries around the world, and Acer subsidiaries in all regions are not only concerned with local social issues, but also take action to participate in community activities. To encourage employees to propose projects that respond to the United Nations' sustainability goals, and in conjunction with the company's Project Humanity global program, the Acer Global ESG Project Awards have been held for six consecutive years to encourage employees to be creative and actively participate in community activities, demonstrating the corporate culture and spirit from the inside out.

The ESG Project Awards incorporate the social return on investment (SROI), the London Benchmark Group (LBG) Framework for assessment of community investment, and the response and contribution to Acer's mission and the United Nations Sustainable Development Goals (SDG) into the assessment rubric for these awards. Through the integration of regional subsidiaries and staff activities, the impact of the ESG program has grown each year, and some subsidiaries have received local ESG awards.

19,325

People Touched and Assisted

257

Partnered Stakeholders

NT\$
39,142,120

Total Monetary Value of All Contributions

11,554

Man-Hours Invested

The 2022 Acer Global ESG Project Awards continued to focus on themes of "education" and "environment" and added "biodiversity" as a sub-theme under the theme of "environment".

The projects developed around the world demonstrated the following features:

• **Leveraging core competencies and products to achieve social impact**

For example, Acer Brazil, Thailand and the Philippines donated computer products to various disadvantaged organizations to help reduce the digital gap, and our colleagues in Taiwan not only donated renovated computers, but also served as volunteers to accompany children from disadvantaged families to help improve their digital abilities.

• **Working in tandem with various stakeholders to create ESG synergy**

We work in tandem with schools, local governments, nonprofit organizations, vendor partners, and customers to solve problems through collaboration with all sectors of the community. For example, Acer America works with suppliers, logistics companies, Acer repair centers, education customers and local recycling centers to design multi-pack boxes for education customers for repair purposes.

• **Active participation by Acer staff, boosting their identification and satisfaction with the Company**

Despite the dramatic changes and impacts of the global epidemic, Acer colleagues continue to care about community and environmental protection issues, and a number of projects focus on the trend of energy saving and carbon reduction, such as the green commuting project in Germany and tree-planting-related projects in the U.S., Vietnam and China, which stood out in the Acer ESG Project Awards.

Nomination of ESG Project Awards



Acer Middle East

Acer Middle East receives Arabia CSR Award

For the third consecutive year, Acer Middle East was awarded in the Small Business category of the Arabia CSR Awards, organized by the Arab CSR Network (ANCSR), which was established in 2004 and received more than 1,100 applications in 2022 from organizations in 14 Arab countries, 43 industry sectors and 13 categories in three different languages (Arabic, English and French). The award recognizes Acer Middle East for its employee care, environmental action and social philanthropy initiatives, including employee and end-user tree planting activities that have resulted in more than 2,000 trees being planted to date.



Education and Digital Inclusion

Acer believes that education is the most valuable investment in the future. Education empowers people to move forward, while technology provides the best help to explore the limits. By putting our core competencies to their fullest use, we hope to achieve the following goals:



Increasing digital inclusion

Enabling more people to gain knowledge and access to technology



Bridging the lack of educational resources

Helping disadvantaged students improve their information skills



Deepening the application of technology in education

Using technology to transform education



Creating Opportunities for Young Learners

Cultivating the next generation of scientists and technologists

Boosting Digital Inclusion and Addressing the Lack of Educational Resources

Technology can bring improvements to quality of life and open up a number of possibilities. Empower everyone enjoy the convenience and opportunities technology brings is one of Acer's goals, and through cooperations between our global locations and non-profit organizations, we are able to extend the reach of technology to different groups. In recent years, we have also encouraged our staff to get involved in activities and transform the results of them into products, school supplies, and funds that can help improve education quality in rural and remote areas. In 2022, Acer Group's social projects around the world made use of Acer's core competencies and products to support disadvantaged or needy communities.

Nomination of ESG Project Awards

Quality and Service Business Unit



Acer volunteers help disadvantaged students enhance digital abilities on a long-term basis

In response to Project Humanity's theme of "Education" and "Environment," the Quality and Service Unit has partnered with the Taiwan Faith Hope Love Development Association in Xizhi since 2020 to assist and accompany disadvantaged children in their computer studies. This volunteer service is provided by Acer volunteers who collect and repair used computers by integrating resources from various units within Acer and design a variety of courses for students, including software, hardware and digital literacy. Even though the program was interrupted by the epidemic, Acer volunteers continued this long-standing volunteer service and received an overwhelming response from the students.



Nomination of ESG Project Awards

Acer Brazil



Acer Brazil supports Little Citizen's House to help disadvantaged communities

Acer Brazil donated 26 notebook computers, 10 monitors, 2 projectors, some accessories and gaming chairs to the NGO Little Citizen's House (originally from [Casa do Pequeno Cidadão](#) in Portuguese). This organization provides shelter for underprivileged children and youth, social inclusion support services for the physically and mentally challenged, and also serves as a day care center for the elderly. Through Acer's donation, disadvantaged children, teenagers and adults will have increased access to the digital world, entertainment and STEM^{Note} education.



Note: STEM is an acronym for Science, Technology, Engineering and Mathematics

Nomination of ESG Project Awards

Acer Thailand

Acer Thailand helps rural schools to implement information education

Ban Sri Pan School in Lampoon, northern Thailand, has 150 students and 12 teachers, 97% of whom come from poor families and 3% of whose parents are ethnic minorities. Acer Thailand communicated with the school to understand the school's needs. Nine colleagues visited the school and donated six AIO computers, one projector and one TV for the computer classroom. In addition, to improve the computer classroom environment and the school's drinking water system, a donation from employees and the company was provided to help the information education in the remote school.



Nomination of ESG Project Awards

Acer Philippines



Acer Philippines' long-term support for The Margaretha Home for the Blind to enhance information capabilities

For the past five years, Acer Philippines has been a long-term donor to the Margaretha Home for the Blind, an organization that cares for 15 visually impaired women, most of whom come from underprivileged families. Acer has been donating laptops and desktops to build computer classrooms, and providing school supplies and daily necessities to help them improve their information skills, in order to support their vision "to see a community of blind people who live decently and with dignity, a community of blind people who support and care for each other".

Creating Opportunities for the Youth

Today's youth are tomorrow's leaders and innovators, and we want to stimulate their potential to become the nourishment of the future. By organizing and sponsoring various activities, we nurture outstanding talents by providing resources such as exchange, training and scholarships for young students who are not afraid of adventures and challenges. We look forward to continuing to use our products and expertise to support young students in building a better future.

For more than 20 years, Acer Foundation has been organizing the Longterm Series of competitions, from the earliest postgraduate thesis competitions to competitions that encourage college and research students to apply their theories to entrepreneurship, and has transformed into a driving force in assisting quality small and medium-sized enterprises. [The 2022 Longterm Smile Competition](#) consists of two groups: international and sustainability, with the expectation of identifying corporate teams that have developed steadily in Taiwan and have plans and potential for overseas operations through invitation to the competition. In addition to offering high prizes to the winning teams, Acer Group's years of multinational experience and integration of marketing capabilities from various locations around the world helps the winning corporate teams optimize their marketing and internationalization, so that the Taiwan teams with potential can develop more quickly towards overseas markets.

Acer sponsors the 2022 International Olympiad in Informatics

Since 2018, Acer has sponsored the [International Olympiad in Informatics \(IOI\)](#) for five consecutive years. For the 34th edition of the competition in Indonesia in 2022, Acer is once again the official sponsor, providing over 350 outstanding high school students from more than 80 countries with all the laptops on site to perform the algorithm design and programming events. The 313 laptops sponsored after the competition were donated to 48 schools and non-profit organizations in Indonesia related to education, health and environment through the "Acer for Education" program.



Nomination of ESG Project Awards

Acer America

Acer America Sponsors LPGA for 10th Consecutive Year

Acer America has been a sponsor of the Ladies Professional Golf Tour (LPGA) for the past 10 years and since 2017 has sponsored the LPGA Leadership Academy, a two-day event that invites 40 young girls, ages 13 to 18, to attend each year. The event provide golf and skill development opportunities to promote female empowerment through group practice, activities and curriculum designed to help develop confidence, communication and leadership skills. Since 2017, Acer has impacted the lives of 200 young girls around the world.



Deepening the Application of Technology to Education

Nomination of ESG Project Awards

Acer America

Gateway Foundation Donates to the Milwaukee Public Schools Foundation

In partnership with AMD, the Gateway Foundation donated 100 R721 laptops to the Milwaukee Public Schools Foundation to provide more than 500 disadvantaged youth with the technology they need to learn, helping to improve students' technical skills in STEM fields and break through the barriers they encounter in their lives through technology education.



Acer America

Acer America Hosts E-Sports Tournament Charity Donation

Acer America hosted the North American Predator League 2022 eSports Competition in October 2022, a two-day online community event where the winner of "The Predator League: Charity Invitational" won US\$25,000 for one of four nonprofit organizations selected by Acer. The Predator League: Charity Invitational The winning team chose [Games for Change](#), an organization dedicated to using games and digital media to drive social change, solve real-world problems, and build a more equitable and sustainable society, while three other nonprofit organizations each received US\$3,000 in donations.

Environmental conservation

Through our volunteer activities, we promote the concept of environmental conservation within the company and work with non-profit organizations to raise the environmental awareness of the community and Acer employees, thereby initiating environmental actions.

Nomination of ESG Project Awards

Acer Poland

Acer Poland Asplex conducts supplier packaging reverse logistics

Acer's Asplex Service Logistics Center in Poland observed that the price of packaging materials continued to rise, and considering the "reduce/reuse/recycle" concept, thought about how to recycle the spare parts boxes provided by suppliers, which are still of good quality but contain many labels, tapes and markings. After testing, the results showed that one person could recycle 3,400 boxes per month; in addition, a paper cutter was used to reuse the boxes as filler material to reduce the cost of cushioning materials. These innovations not only reduce costs and carton waste, but also further reduce CO₂ emissions and trees felling.



Nomination of ESG Project Awards

Acer Spain

Acer Spain Installed Rooftop Solar Panel

Acer Spain has installed more than 100 solar panels on the top floor of its offices in 2022 to meet its commitment to use 100% renewable energy by 2035. By generating solar power for its own use, it can produce 80 megawatt hours of renewable energy per year, reduce electricity costs and cut CO₂ emissions by about 27 tons, which is equivalent to planting 1,182 trees.



Nomination of ESG Project Awards

Acer America

Acer America Designs Multi-Pack Boxes with Cost, Environmental and Social Benefits

Acer America designed the multi-packing box to support education customers with warehouse repair shipments. By using a single box for 10 notebooks instead of 10 individual boxes, education customers can more easily pack, ship and receive repaired equipment; in addition, the box can be reused up to four times, reducing corrugated cardboard material usage, packaging and shipping costs. Participants in this project include packaging material suppliers, logistics companies, Acer repair centers, educational customers and the Temple City Recycling Center, saving approximately US\$500,000 per year in transportation and packaging costs and reducing CO₂ emissions by 109.98 MTCO₂E. At the same time, it enhances the relationship with important education customers and brings convenience and social benefits to education customers in terms of maintenance process.



Nomination of ESG Project Awards

Acer America

Acer America Volunteers help harvest seeds from native seed farms

The [Irvine Ranch Conservancy Native Seed Farm](#) in California was created with the goal of restoring nearly 5,000 acres of native habitat and is therefore actively cultivating native seeds. Acer's USA Irvine colleagues volunteered to help harvest the native seeds, which will be separated, bagged, labeled, and placed in climate-controlled storage sheds for future restoration in local parks and nature preserves.



Acer Germany

Travemünde Beach Cleanup

German colleagues cleaned up 15 kg of trash during the Travemünde Beach Cleanup in September.

Nomination of ESG Project Awards

Acer Germany

Acer Germany Re-launches Bike Challenge

Acer Germany is once again launching a bicycle challenge in 2022 to encourage employees to commute to work by bicycle in order to promote employee health and reduce CO₂ emissions. Designed by Acer Germany's IT department, the tracking tool allows all work-related or every trip that occurs during working hours to be entered into the tracking tool. This green initiative not only helped to increase employee satisfaction and fun, but also gave them the opportunity to earn rewards. 32 Acer employees eventually participated, riding 11,527 km and reducing 1,383 kg of CO₂ emissions.



Nomination of ESG Project Awards

Acer India

Acer India participates in Earth Hour

Acer India is participating in Earth Hour by turning off all office lights between 4:30 p.m. and 5:30 p.m. on March 25 and not printing any documents during the afternoon. At the same time, we also launched a Green Month campaign to raise awareness and create a positive impact on the environment through weekly thematic green actions such as reducing the use of plastic bags and disposable utensils, and finally donating the second-hand materials collected to the [Rakum School for the Blind](#) in Indiranagar, Bangalore.



Nomination of ESG Project Awards

Acer Vietnam

Acer Vietnam supports the World Environment Day

In response to World Environment Day, Acer Vietnam encouraged its employees to go green in their offices and homes in June. In the office, employees from different office areas compete in a green action competition, and each action translates into a tree planting fund; in the home, employees are required to take photos to record their family members' participation in green activities. In the end, 99 green initiatives were carried out and 99 trees were planted.



Nomination of ESG Project Awards

Acer China



Acer China organizes "The Future of the Earth is Beautiful Because of You" environmental campaign

Acer China collaborated with netizens and lifestyle celebrities to invite the public to take part in environmental protection actions. 500,000 people participated in this campaign increasing public awareness of environmental protection.



Nomination of ESG Project Awards

Acer China

Acer China encourages colleagues to take green actions

Through the "Ant Forest" Internet public welfare platform, Acer China encourages colleagues to donate the virtual green energy gained from green travel and green recycling to projects such as carbon neutral Asian Games, habitat protection and tree planting, with an accumulative total of 2,738 kg of energy donated.



Nomination of ESG Project Awards

Acer Taiwan

Acer Taiwan holds Reusable Bag Campaign

In the spirit of Project Humanity, Acer Taiwan held the "Reusable Bag Campaign" to encourage employees to donate their personal environmental bags for those in need to take away. In the end, 425 bags were collected and 143 bags were collected by colleagues. The remaining bags were donated to stores in need through the social enterprise [Ubag](#), allowing more reusable bags to replace plastic bags.

Stay safe, go green !

The event was great, it brought together the strengths of everyone who participated in the event and in the midst of the pandemic. Thank you for your donation, I will respond to environmental protection, take good care of the earth, reuse bags well, and cut down on plastic bags.

Alice Tien

PLM & Account Service Dept. Acer Headquarters



Charity

We have worked with several local charities around the world for many years. These partnerships not only help communities, but also strengthen our ties to them. We work with communities to address pressing social challenges through our many programs of social care, fundraising activities and disaster relief.

Volunteers contribute to the community

Acer encourages its employees to devote themselves to public service in addition to their work, so that they can gain new experiences and ideas, and gain new energy to face the challenges of work and customers. Acer employees are entitled to two days of paid volunteer leave per year.

Acer Switzerland

Sponsored the 7th SOS Children's Village Charity Soccer Tournament to help build schools in remote areas.

Nomination of ESG Project Awards

Acer Poland

Acer Poland Asplex organizes and donates EMEA supplies to Ukrainian refugees

After the outbreak of the Russian-Ukrainian war, many Ukrainian people sought refuge in Poland. Acer EMEA employees volunteered to collect and deliver supplies to the Asplex Service Logistics Center in Poland, which organized and coordinated supplies to provide humanitarian assistance to Ukrainian refugees traveling to Poland.

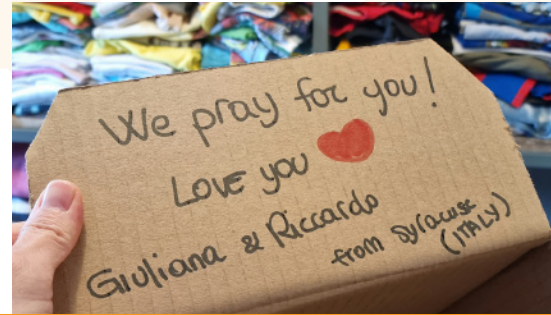

Acer Taiwan

In cooperation with the [Old Five Old Foundation](#), the Acer Volunteer Team has worked over the past 12 years to deliver piping hot meals to residents in communities in Xizhi, Shenkeng, and Shiding for Chinese New Year, helping solo elderly people and disadvantaged families who may have long suffered with nutritional or mobility issues with some warmth for the festive season.

Regular blood donation drives are held to provide the most direct support to health care units in times of severe epidemics, with 965 participants donating 1,495 bags of blood in 2022.

To help prevent the epidemic, Acer Foundation donated a total of 345 "Super Oxygen Anti-Bacteria Machines" to the Taoyuan City Education Bureau, Chiayi County and Chiayi City government, and two elementary schools in Ruifang District, New Taipei City, to improve the anti-bacterial effect of washing by incorporating superoxide ions (ozone) into the water through negative pressure super oxygen to protect children's health.

Acer Germany

Our German colleagues supported the PET bottle recycling campaign by donating the PET bottle recycling money collected in the office building, together with donations from our company and colleagues, totaling 2,500 Euros, to the Blue Elephant Children's Home, which provides various kinds of help to children and families living in difficulties.

Nomination of ESG Project Awards

Acer Taiwan

Acer Taiwan expands used goods collection event

Every year, Acer Taiwan holds a used goods drive to donate to charity organizations. In 2022, we expanded the recycling category to include clothing and shoes, and 600 colleagues joined the drive. 75 computers, 168 cell phones, 120 kg of batteries, 76 kg of other electronic equipment, over 400 pieces of clothing, and over 200 pieces of shoes were successfully collected. The Acer volunteer team donated these materials to the [Eden Foundation](#), the [Taipei Orphan Welfare Foundation](#), the [Step30 International Ministries](#) and electronic waste recyclers, not only to increase employee participation in the company's Project Humanity, but also to help the disadvantaged groups and environmental protection.



Acer South Africa

Donate to [CHOC Childhood Cancer Foundation South Africa](#) and hold a one-day office slipper day with the theme "Have a heart and wear a Sole" to show support to children and their families battling childhood cancer - they are not walking alone, we are walking with them every step of the way.





Summary of ESG Information

Economic	Unit	2019	2020	2021	2022	GRI Indicators	Page No.
Consolidated Revenue	NTD Billion	234.285	277.112	319.005	275.424	201-1	12
Operation Profit (Loss)	NTD Billion	3.078	8.936	14.163	6.928	201-1	12
After Tax Earnings (Loss)	NTD Billion	2.63	6.029	10.897	5.004	201-1	12
Basic Earnings Per Share	NTD	0.87	2.01	3.63	1.67	201-1	12
Operation Expenses	NTD Billion	(21.734)	(21.413)	(23.140)	(22.955)	201-1	12
Staff Remuneration and Welfare	NTD Billion	(12.848)	(13.112)	(14.901)	(14.251)	201-1	12
Dividends	NTD	0.77	1.50	2.28	1.50	201-1	12
Income Tax Expense (Benefits)	NTD Billion	(1.144)	(2.759)	(4.148)	(2.271)	201-1	12
Liabilities	NTD Billion	96.901	121.967	148.765	118.606	201-1	12
Equity	NTD Billion	59.195	61.942	66.023	70.434	201-1	12



Environmental		Items	Unit	2019	2020	2021	2022	GRI Indicators	Page No.
Total Input	Direct Energy Usage	Natural Gas	m ³	443,287.84	333,864.00	547,681.20	513,488.56	302-1	-
		Energy Consumption	GJ	16512.59	12,436.52	20,775.46	18,485.44	302-1	-
		% of total energy consumption	%	9.41	7.75	13.29	12.06	302-1	-
		Gasoline	liters	631,662.83	643,651.27	187,099.30	274,755.91	302-1	-
		Energy Consumption	GJ	21,287.04	21,691.05	6,305.25	9,259.27	302-1	-
		% of total energy consumption	%	12.13	13.52	4.03	6.04	302-1	-
		Diesel	liters	486,469.00	314,062.49	411,707.22	417,865.96	302-1	-
		Energy Consumption	GJ	18,777.70	12,122.81	15,891.90	16,129.63	302-1	-
		% of total energy consumption	%	10.70	7.55	10.17	10.53	302-1	-
	Water ^{Note 1}	m ³	190,048	173,805	164,324	162,655	306-1	67	
Total Output	Indirect Energy Resource Usage	Green Electricity ^{Note 2}	kWh	14,425,614.18	13,848,251.08	14,009,991.58	13,334,372.39	302-1	107
		Electricity Consumption	kWh	33,018,640.19	31,734,912.68	31,480,280.89	30,644,472.02	302-1	115
		Energy Consumption	GJ	118,867.10	114,245.69	113,329.01	109,367.76	302-1	115
		% of total energy consumption	%	67.75%	71.18	72.51	71.37	302-1	115
	GHG Emissions	Scope 1	Tonnes of CO ₂ equivalent	3,540.21	3,004.03	4,550.63	2,705.30	305-1	112
		Scope 2 - market-based		10,223.62	9,195.35	8,746.1	8,784.50	305-2	112
	Waste Water	Sewage Discharge ^{Note 3}	Tonnes	152,038	139,044	131,459	130,124	306-1	67
	Wastes	Total Generated	Tonnes	1,666.61	1,803.70	1,947.62	2,112.51	306-2	65
		Total Recycled and Reuse	Tonnes	1,135.60	1,373.02	1,562.19	1,685.20	306-2	65
		Recycled Resources	Tonnes	726.20	866.75	998.87	977.59	306-2	65
		Electronic Waste	Tonnes	409.40	506.27	563.32	707.61	306-2	65
Non Recycled and Reuse		Tonnes	531.01	430.68	385.43	427.31	306-2	65	
	Municipal Solid Waste	Tonnes	531.01	430.68	385.43	427.31	306-2	65	

Note 1: The statistical scope of water usage, municipal solid wastes and recycled resources: cover 100% of Acer global staff (some regional data uses per-capita estimates); The statistical scope of electronic wastes: cover 100% of Acer global staff; From 2020 onward, water usage incorporated well water.

Note 2: Green electricity includes self-consumption of renewable electricity and renewable energy certificates.

Note 3: Sewage accounts for an estimated 80% of water usage, with the remaining 20% used for air conditioning. The scope of this data is consistent with previous years' water usage data scope.



Social	Items	Unit	2019	2020	2021	2022	GRI Indicators	Page No.
Staff Employment	Number of Employees ^{Note 1}	People	7,923	7,467 ^{Note 1}	7,713	7,725	2-7	126
	Average Age	Years	40.0	40.2	40.4	41	-	-
	Average Seniority	Years	8.7	8.7	8.8	9.2	-	-
	Turnover Rate ^{Note 2}	%	16.5	15.4	13.8	13.2	401-1	128-130
	Voluntary Turnover Rate	%	15.5	15.4	12.5	10.6	-	130
	Hiring Rate	%	15.7	16.4	17.9	13	401-1	128
	Applicants for Parental Leave	%	23.7	21.2	11.7	12.05	401-3	133
	Post Parental Leave Return-to-Work Rate ^{Note 3}	%	62.5	42.9	72.7	105.88	401-3	133
	Post Parental Leave Retention Rate	%	57.14	80	100	71.43	401-3	133
Continuing Learning and Growth ^{Note 4}	Average Number of Training Hours for Staff Members	hours	13.2	13.3	13.4	13.52	404-1	137
Health and Safety in the Workplace ^{Note 5}	Disabling Injury Rate (IR)	-	0.25	0.53	0.44	0.24	403-2	145
	Lost Day Rate (LDR)	-	1.76	9.6	3.83	2.64	403-2	145
	Absentee Rate ^{Note 6}	%	1.39	1.28	0.98	2.1	403-2	-
Community Engagement and Investment	Financial Value of Community Engagement and Investment	10 thousand NT\$	5,643	5,845	5,116	3,914	-	149
Donation Type	Cash	%	41	80	39	54	-	149
	Time, Products, or Other In-Kind Donations	%	59	20	61	46	-	149
Participation Type	Community Investment	%	62	58	52	62	-	149
	Charitable Donations	%	25	21	30	13	-	149
	Commercial Initiatives	%	13	21	19	25	-	149

Note 1: Includes regular and full-time staff

Note 2: This data represents the 2021 turnover rate for full-time staff.

Note 3: The statistics of Applicants for Parental Leave, Post Parental Leave Return-to-work Rate, and Post Parental Leave Retention Rate cover the Taiwan region staff.

Note 4: The statistical scope covers global regions staff.

Note 5: This chart's statistics cover injury and lost day rates for the Taiwan. For global occupational accident statistics 2022, please refer to page 145.

Note 6: Including sickness leave (menstrual leave, occupational sickness leave, and special sickness leave) and personal leave. Data from 2019 to 2021 primarily focuses on staffs in Taiwan. However, data for the year 2022 includes all global operational headquarters (except for the Pan Asia Pacific Operations).



Appendix

| About this Report

Transparency in disclosure is an important concern for Acer, which has issued a Sustainability Report for 15 consecutive years (starting in 2021, the name has been changed from Corporate Responsibility Report to Sustainability Report). We issue the report in both Chinese and English, and for the convenience of readers, we also publish the executive summary in Chinese, English, and German editions. This report discloses information on performance in corporate governance, environmental, and social issues, as well as future plans, enabling interested parties to better understand Acer's efforts and achievements in sustainable development. Previous years' Sustainability Reports and the latest information on sustainable development are available at the [Acer Group's sustainability website](#).

Report Boundaries and Scope

This report is based on the principles of consolidated financial statements with regard to organizational boundaries. In scope, this report includes the Acer Group's subsidiaries, the Acer Foundation and the StanShih Foundation, but does not include reinvestment matters, and some performance information is not yet fully incorporated; where the information in the environmental section does not include the abovementioned foundations. Adjustments or estimates, if any, are separately stated in the text of the report. For more detailed organizational and financial information, please refer to the Acer Group's annual report "Special Items: I. Information on Affiliates" and the Acer Group's "[Investor Relations](#)" page.

Report Compilation Principles and Statement of Use

Acer reports and discloses the Company's performance on key sustainability issues in accordance with the Global Reporting Initiative's (GRI) GRI Guidelines for 2022 (January 1, 2022 through December 31, 2022). For the sake of information completeness and comparability, a portion of the performance data disclosed dates back to before 2023 or forward into 2021.

Report Issuing Dates and Frequency

Acer issues Sustainability Reports each year. This report is issued in June 2023, with the previous report issued in June 2022. We have also adopted the Sustainability Accounting Standard Board (SASB) Sustainability Indicators and the Task Force on Climate related Financial Disclosures (TCFD) framework. At the end of the report, we have included a cross-reference to the GRI and SASB indicators, a comparison table to the UN Global Compact, and industry-specific sustainability indicators in accordance with the "Rules Governing the Preparation and Filing of Sustainability Reports by TWSE Listed Companies."

Responses and Feedback

If you have any questions or suggestions regarding the Acer 2022 Sustainability Report or sustainability or ESG issues, you are welcome to contact us. Our contact details are:

Acer ESG Office

Address: 10F., No. 88, Xintaiwu Rd. Sec. 1, Xizhi Dist., New Taipei City

Phone: 02-26963232

Email: cr@acer.com



Download Report

Report Preparation and Quality Management Process

In 2022, to strengthen Acer's sustainability report preparation and verification operations, the "Procedures for the Preparation and Verification of Acer's Sustainability Report" was established in accordance with the "Rules Governing the Preparation and Filing of Sustainability Reports by TWSE Listed Companies" announced by the Taiwan Stock Exchange. In addition to regulating the principles of preparation, the verification, reporting and disclosure, and internal control of the report are also regulated.



Data Collection

Report Compilation Task Force

Collecting Relevant Information Based on Major Topics

- Objectives and Management Indicators
- Outcomes
- Future Objectives and Plans



Compilation

ESG Office

- Overall Planning
- Report Main Theme
- Editorial Revision



Review

Internal Verification

Acer Internal Department Heads
Corporate Sustainability Committee

- Acer internal department heads confirm data integrity and correctness
- The Corporate Sustainability Committee oversees and reviews key ESG strategic objectives and performance
- Acer has established a "Sustainability Report Preparation and Verification Process" and the auditing department regularly reviews the status of implementation and execution.

External Verification

External Third Party

- **Sustainable Data and Information:** We commissioned SAS Taiwan (SGS) to conduct independent limited assurance in accordance with the ISAE3000 standard, and management such as Chief Sustainability Officer are also involved in the verification process and interviewed.
- **Financial Data:** All financial data in this report has been verified by KPMG Certified Public Accountants
- **Data Relating to Greenhouse Gases:** GHG-related data has undergone verification by SGS and is in accordance with ISO 14064.



Finalization

Members of Corporate Sustainability Committee

- Review the final draft



GRI Standards Indicators

Statement of use	Acer Incorporated has reported in accordance with the GRI Standards for the period from January 1, 2002 to December 31, 2022.	GRI 1 used	GRI 1: Foundation 2021	Applicable GRI Sector Standard(s)	NA
-------------------------	---	-------------------	------------------------	--	----

General disclosures

GRI STANDARD / OTHER SOURCE	DISCLOSURE	LOCATION	OMISSION		
			REQUIREMENT(S) OMITTED	REASON	EXPLANATION
GRI 2: General Disclosures 2021	2-1 Organizational details	About the company	-	-	-
	2-2 Entities included in the organization's sustainability reporting	About the report	-	-	-
	2-3 Reporting period, frequency, and contact point	About the report	-	-	-
	2-4 Restatements of information	No restatement of information provided in previous report	-	-	-
	2-5 External assurance	Independent limited assurance report	-	-	-
	2-6 Activities, value chain and other business relationships	About the company, Responsible Supply Chain, Customer Service	-	-	-
	2-7 Employees	Talent attraction and development	-	-	-
	2-8 Workers who are not employees	Talent attraction and development	-	-	-
	2-9 Governance structure and composition	Corporate Governance	-	-	-
	2-10 Nomination and selection of the highest governance body	Corporate Governance	-	-	-
	2-11 Chair of the highest governance body	Corporate Governance	-	-	-
	2-12 Role of the highest governance body in overseeing the management of impacts	Corporate Governance	-	-	-
	2-13 Delegation of responsibility for managing impacts	ESG Governance and 2025 Sustainability Goals	-	-	-
	2-14 Role of the highest governance body in sustainability reporting	ESG Governance and 2025 Sustainability Goals	-	-	-



GRI STANDARD / OTHER SOURCE	DISCLOSURE	LOCATION	OMISSION		
			REQUIREMENT(S) OMITTED	REASON	EXPLANATION
GRI 2: General Disclosures 2021	2-15 Conflicts of interest	Corporate Governance	-	-	-
	2-16 Communication of critical concerns	Corporate Governance	-	-	-
	2-17 Collective knowledge of the highest governance body	Corporate Governance	-	-	-
	2-18 Evaluation of the performance of the highest governance body	Corporate Governance	-	-	-
	2-19 Remuneration policies	Corporate Governance	-	-	-
	2-20 Process to determine remuneration	Corporate Governance	-	-	-
	2-21 Annual total compensation ratio	Corporate Governance	-	-	-
	2-22 Statement on sustainable development strategy	ESG Governance and 2025 Sustainability Goals	-	-	-
	2-23 Policy commitments	Corporate Governance, Human Rights Protection, ESG Governance and 2025 Sustainability Goals	-	-	-
	2-24 Embedding policy commitments	Corporate Governance, Human Rights Protection, ESG Governance and 2025 Sustainability Goals	-	-	-
	2-25 Processes to remediate negative impacts	Materiality and Stakeholder Engagement - Chapter 3: Corporate Governance-Reporting and Protection; Chapter 7: Inclusive Workplace and Society-Assessment of Potential Human Rights Issues	-	-	-
	2-26 Mechanisms for seeking advice and raising concerns	Corporate Governance	-	-	-
	2-27 Compliance with laws and regulations	Corporate Governance	-	-	-
	2-28 Membership associations	Materiality and Stakeholder Engagement	-	-	-
	2-29 Approach to stakeholder engagement	Materiality and Stakeholder Engagement	-	-	-
2-30 Collective bargaining agreements	Human Rights Protection	-	-	-	



Material Topics

GRI STANDARD / OTHER SOURCE	DISCLOSURE	LOCATION	OMISSION		
			REQUIREMENT(S) OMITTED	REASON	EXPLANATION
GRI 3: Material Topics 2021	3-1 Process to determine material topics	Materiality and Stakeholder Engagement	-	-	-
	3-2 List of material topics	Materiality and Stakeholder Engagement	-	-	-

Material Topic: Energy, Carbon Emissions and Climate Action

GRI STANDARD / OTHER SOURCE	DISCLOSURE	LOCATION	OMISSION		
			REQUIREMENT(S) OMITTED	REASON	EXPLANATION
GRI 3: Material Topics 2021	3-3 Management of material topics	-	-	-	-
GRI 305: Emissions 2016	305-1 Direct (Scope 1) GHG emissions	Greenhouse Gas Emissions	-	-	-
	305-2 Energy indirect (Scope 2) GHG emissions	Greenhouse Gas Emissions	-	-	-
	305-3 Other indirect (Scope 3) GHG emissions	Greenhouse Gas Emissions	-	-	-
	305-4 GHG emissions intensity	Greenhouse Gas Emissions	-	-	-
	305-5 Reduction of GHG emissions	Greenhouse Gas Emissions	-	-	-
	305-7 Nitrogen oxides (NOX), sulfur oxides (SOX), and other significant air emissions	Acer's global operations are primarily focused on product sales and customer service, and its facilities are largely office buildings; as such, the company produces no volatile organic compounds.	-	-	-
GRI 302: Energy 2016	302-1 Energy consumption within the organization	Summary of ESG Information-Environmental	-	-	-
	302-2 Energy consumption outside of the organization	Greenhouse Gas Emissions	-	-	-
	302-3 Energy intensity	Summary of ESG Information-Environmental	-	-	-
	302-4 Reduction of energy consumption	Operations and Environment	-	-	-
GRI 201: Economic Performance 2016	201-2 Financial implications and other risks and opportunities due to climate change	Climate Risks and Opportunities and Climate-Related Financial Disclosures (TCFD)	-	-	-



Material Topic: Information Security and Privacy Protection

GRI STANDARD / OTHER SOURCE	DISCLOSURE	LOCATION	OMISSION		
			REQUIREMENT(S) OMITTED	REASON	EXPLANATION
GRI 3: Material Topics 2021	3-3 Management of material topics	Information Security and Privacy Protection	-	-	-
GRI 418: Customer Privacy	418-1 Substantiated complaints concerning breaches of customer privacy and losses of customer data	Information Security and Privacy Protection	-	-	-
Other Standard Disclosure	Acer-EC1 Information Security Governance	Information Security and Privacy Protection	-	-	-

Material Topic: Innovative R&D and Design

GRI STANDARD / OTHER SOURCE	DISCLOSURE	LOCATION	OMISSION		
			REQUIREMENT(S) OMITTED	REASON	EXPLANATION
GRI 3: Material Topics 2021	3-3 Management of material topics	Innovative Products and Services	-	-	-
Other Standard Disclosure	Acer-EC4 Innovative technology and application	Innovative Products and Services	-	-	-
	Acer-EC5 Open source and collaborative innovation	Innovative Products and Services	-	-	-
	Acer-EC6 Acquisition and protection of intellectual property rights	Innovative Products and Services	-	-	-

Material Topic: Product Responsibility and Customer Safety

GRI STANDARD / OTHER SOURCE	DISCLOSURE	LOCATION	OMISSION		
			REQUIREMENT(S) OMITTED	REASON	EXPLANATION
GRI 3: Material Topics 2021	3-3 Management of material topics	Product Life Cycle	-	-	-
GRI 416: Customer Health and Safety 2016	416-1 Assessment of the health and safety impacts of product and service categories	The main products are managed by our quality assurance department and are 100% compliant with RoHS and product safety related regulations.	-	-	-
	416-2 Incidents of non-compliance concerning the health and safety impacts of products and services	Corporate Governance	-	-	-
GRI 417: Marketing and Labeling 2016	417-1 Assessment of the health and safety impacts of product and service categories	All product, service information and labeling are meeting environmental as well as social regulation.	-	-	-
Other Standard Disclosure	Acer-EN1 Halogen-free products launched	Product Life Cycle	-	-	-



Material Topic: Circular Economies and Product Life Cycle

GRI STANDARD / OTHER SOURCE	DISCLOSURE	LOCATION	OMISSION		
			REQUIREMENT(S) OMITTED	REASON	EXPLANATION
GRI 3: Material Topics 2021	3-3 Management of material topics	Product Life Cycle	-	-	-
GRI 301: Materials 2016	301-1 Materials used by weight or volume	Product Life Cycle	-	-	-
	301-2 Recycled input materials used	Product Life Cycle	-	-	-
	301-3 Reclaimed products and their packaging materials	Product Life Cycle	-	-	-
GRI 302: Energy 2016	302-5 Reductions in energy requirements of products and services	Product Life Cycle	-	-	-

Material Topic: Corporate Governance and Code of Ethics/Standards of Conduct

GRI STANDARD / OTHER SOURCE	DISCLOSURE	LOCATION	OMISSION		
			REQUIREMENT(S) OMITTED	REASON	EXPLANATION
GRI 3: Material Topics 2021	3-3 Management of material topics	Corporate Governance	-	-	-
GRI 405: Diversity and Equal Opportunity 2016	405-1 Diversity and Equal Opportunity	Corporate Governance	-	-	-
GRI 416: Customer Health and Safety 2016	416-1 Incidents of non-compliance concerning the health and safety impacts of products and services	Corporate Governance	-	-	-
GRI 417: Marketing and Labeling 2016	417-2 Incidents of non-compliance concerning product and service information and labeling	Corporate Governance	-	-	-
	417-3 Incidents of non-compliance concerning marketing communications	Corporate Governance	-	-	-



Material Topic: Talent Attraction, Retention, and Development

GRI STANDARD / OTHER SOURCE	DISCLOSURE	LOCATION	OMISSION		
			REQUIREMENT(S) OMITTED	REASON	EXPLANATION
GRI 3: Material Topics 2021	3-3 Management of material topics	Talent attraction and development	-	-	-
GRI 201: Economic Performance 2016	201-1 Direct economic value generated and distributed	Talent attraction and development Status of Operations	-	-	-
GRI 401: Employment	401-1 New employee hires and employee turnover	Talent attraction and development	-	-	-
	401-2 Benefits provided to full-time employees that are not provided to temporary or part-time employees	Talent attraction and development	-	-	-
	401-3 Parental leave	Talent attraction and development	-	-	-
GRI 402: Labor/Management Relations	402-1 Minimum notice periods regarding operational changes	Where there are major changes in our operations, Acer will always notify staff of any impact such changes may have on them in accordance with local laws.	-	-	-
GRI 404: Training and Education 2016	404-1 Average hours of training per year per employee	Talent attraction and development	-	-	-
	404-2 Programs for upgrading employee skills and transition assistance programs	Talent attraction and development	-	-	-
	404-3 Percentage of employees receiving regular performance and career development reviews	Talent attraction and development	-	-	-

Material Topic: Human Rights, Equality, and Diversity

GRI STANDARD / OTHER SOURCE	DISCLOSURE	LOCATION	OMISSION		
			REQUIREMENT(S) OMITTED	REASON	EXPLANATION
GRI 3: Material Topics 2021	3-3 Management of material topics	Human Rights Protection	-	-	-
GRI 405: Diversity and Equal Opportunity 2016	405-1 Diversity of governance bodies and employees	Talent attraction and development	-	-	-
	405-2 Ratio of basic salary and remuneration of women to men	Talent attraction and development	-	-	-



GRI STANDARD / OTHER SOURCE	DISCLOSURE	LOCATION	OMISSION		
			REQUIREMENT(S) OMITTED	REASON	EXPLANATION
GRI 406: Non-discrimination 2016	406-1 Incidents of discrimination and corrective actions taken	Human Rights Protection	-	-	-
GRI 407: Freedom of Association and Collective Bargaining 2016	407-1 Operations and suppliers in which the right to freedom of association and collective bargaining may be at risk	Human Rights Protection In 2022, there were no cases where human rights issues were reviewed by the local government.	-	-	-
GRI 408: Child Labor 2016	408-1 Operations and suppliers at significant risk for incidents of child labor	Human Rights Protection No significant risk of the use of child or youth labor	-	-	-
GRI 409: Forced or Compulsory Labor 2016	409-1 Operations and suppliers at significant risk for incidents of forced or compulsory labor	Human Rights Protection In 2022, there were no cases where human rights issues were reviewed by the local government.	-	-	-
GRI 412: Human Rights Assessment 2016	412-1 Operations that have been subject to human rights reviews or impact assessments	Human Rights Protection	Human Rights Protection	Human Rights Protection	Human Rights Protection
	412-2 Employee training on human rights policies or procedures	Human Rights Protection	-	-	-

Material Topic: Water Resource Management

GRI STANDARD / OTHER SOURCE	DISCLOSURE	LOCATION	OMISSION		
			REQUIREMENT(S) OMITTED	REASON	EXPLANATION
GRI 3: Material Topics 2021	3-3 Management of material topics	Operations and Environment	-	-	-
GRI 303: Water and Effluents 2018	303-1 Interactions with water as a shared resource	Operations and Environment	-	-	-
	303-2 Management of water discharge-related impacts	Operations and Environment	-	-	-
	303-3 Water withdrawal	Operations and Environment, The main source of water is the municipal supply, and there is no significant impact on this source, so the water pressure area and water quality are not further identified.	-	-	-
	303-4 Water discharge	Operations and Environment	-	-	-
	303-5 Water consumption	Operations and Environment	-	-	-



Material Topic: Supplier Environmental and Social Management & Performance

GRI STANDARD / OTHER SOURCE	DISCLOSURE	LOCATION	OMISSION		
			REQUIREMENT(S) OMITTED	REASON	EXPLANATION
GRI 3: Material Topics 2021	3-3 Management of material topics	Responsible Supply Chain	-	-	-
GRI 2: General Disclosures 2021	2-6 Activities, value chain and other business relationships	Acer's Supply Chain	-	-	-
GRI 308: Supplier Environmental Assessment 2016	308-1 New suppliers that were screened using environmental criteria	Supply Chain Management Mechanisms	-	-	-
	308-2 Negative environmental impacts in the supply chain and actions taken	Supply Chain Audit and Improvement	-	-	-
GRI 407: Freedom of Association and Collective Bargaining 2016	407-1 Operations and suppliers in which the right to freedom of association and collective bargaining may be at risk	Responsible Supply Chain, Human Rights Protection	-	-	-
GRI 408: Child Labor 2016	408-1 Operations and suppliers at significant risk for incidents of child labor	Supply Chain Audit and Improvement Supply Chain Social Management	-	-	-
GRI 409: Forced or Compulsory Labor 2016	409-1 Operations and suppliers at significant risk for incidents of forced or compulsory labor	Supply Chain Social Management	-	-	-
GRI 414: Supplier Social Assessment 2016	414-1 New suppliers that were screened using social criteria	Supply Chain Management Mechanisms	-	-	-
	414-2 Negative social impacts in the supply chain and actions taken	Supply Chain Audit and Improvement Supply Chain Social Management	-	-	-
Other Standard Disclosure	Acer-SO3 Publish of Smelter List and annual Conflict Minerals Report	Supply Chain Social Management	-	-	-



Material Topic: Occupational Health and Safety

GRI STANDARD / OTHER SOURCE	DISCLOSURE	LOCATION	OMISSION		
			REQUIREMENT(S) OMITTED	REASON	EXPLANATION
GRI 3: Material Topics 2021	3-3 Management of material topics	Health and Safety in the Workplace	-	-	-
GRI 403: Occupational Health and Safety 2018	403-1 Occupational health and safety management system	Health and Safety in the Workplace	-	-	-
	403-2 Hazard identification, risk assessment, and incident investigation	Health and Safety in the Workplace	-	-	-
	403-3 Occupational health services	Health and Safety in the Workplace	-	-	-
	403-4 Worker participation, consultation, and communication on occupational health and safety	Health and Safety in the Workplace	-	-	-
	403-5 Worker training on occupational health and safety	Health and Safety in the Workplace	-	-	-
	403-6 Promotion of worker health	Health and Safety in the Workplace	-	-	-
	403-7 Prevention and mitigation of occupational health and safety impacts directly linked by business relationships	Health and Safety in the Workplace	-	-	-
	403-8 Workers covered by an occupational health and safety management system	Health and Safety in the Workplace	-	-	-
	403-9 Work-related injuries	Health and Safety in the Workplace	-	-	-
	403-10 Work-related ill health	Health and Safety in the Workplace	-	-	-

Material Topic: Policy and Public Issues Advocacy

GRI STANDARD / OTHER SOURCE	DISCLOSURE	LOCATION	OMISSION		
			REQUIREMENT(S) OMITTED	REASON	EXPLANATION
GRI 3: Material Topics 2021	3-3 Management of material topics	-	-	-	-
GRI 2: General Disclosure 2021	2-28 Membership associations	Materiality and Stakeholder Engagement	-	-	-
GRI 415: Public Policy	415-1 Political contributions	Acer made no political contribution in 2022.	-	-	-



Material Topic: Biodiversity

GRI STANDARD / OTHER SOURCE	DISCLOSURE	LOCATION	OMISSION		
			REQUIREMENT(S) OMITTED	REASON	EXPLANATION
GRI 3: Material Topics 2021	3-3 Management of material topics	-	-	-	-
GRI 304: Biodiversity 2016	304-1 Operational sites owned, leased, managed in, or adjacent to, protected areas and areas of high biodiversity value outside protected areas	Operations and Environment	-	-	-
	304-2 Significant impacts of activities, products, and services on biodiversity	Operations and Environment	-	-	-
	304-3 Habitats protected or restored	Operations and Environment	-	-	-
	304-4 IUCN Red List species and national conservation list species with habitats in areas affected by operations	Operations and Environment	-	-	-

Material Topic: Digital Inclusion and Social Philanthropy

GRI STANDARD / OTHER SOURCE	DISCLOSURE	LOCATION	OMISSION		
			REQUIREMENT(S) OMITTED	REASON	EXPLANATION
GRI 3: Material Topics 2021	3-3 Management of material topics	Digital Inclusion and Social Philanthropy	-	-	-
GRI 201: Economic Performance 2016	201-1 Direct economic value generated and distributed	Digital Inclusion and Social Philanthropy Status of Operations	-	-	-
GRI 203: Indirect Economic Impacts 2016	203-2 Significant indirect economic impacts	Digital Inclusion and Social Philanthropy	-	-	-
Other Standard Disclosure	Acer-SO1 Activities of corporate citizenship and philanthropy	Digital Inclusion and Social Philanthropy	-	-	-
	Acer-SO2 Digital Inclusion activity	Digital Inclusion and Social Philanthropy	-	-	-



| SASB Standards

Table 1. Sustainability Disclosure Topics & Accounting Metrics

Code	Accounting Metric	Disclosure Content and Relevant Chapters	External Assurance										
Product Security													
TC-HW-230a.1	Description of approach to identifying and addressing data security risks in products	For related content, please refer to the “Product Security” and “Information Security & Privacy Protection” chapters.	Assured by SGS										
Employee Diversity & Inclusion													
TC-HW-330a.1	Percentage of gender and racial/ethnic group representation for (1) management (2) technical staff, and (3) all other employees	For related content, please refer to the “Staff Structure” section of the “Attracting and Developing Talent” chapter.	Assured by SGS										
Product Life Cycle													
TC-HW-410a.1	Percentage of products by revenue that contain IEC 62474 declarable substances	For related content, please refer to the “Circular Economies and Product Life Cycle” chapter.	Assured by SGS										
TC-HW-410a.2	Percentage of eligible products, by revenue, meeting the requirements for EPEAT registration or equivalent	<table border="1" style="width: 100%; border-collapse: collapse;"> <thead> <tr> <th></th> <th>Products Containing IEC 62474 Declared Substances</th> <th>Products Applying for EPEAT or Equivalent Environmental Label</th> <th>Products Applying for Energy Star</th> <th>Products Applying the TCO Certificated</th> </tr> </thead> <tbody> <tr> <td>Shipment</td> <td style="text-align: center;">100%</td> <td style="text-align: center;">13%</td> <td style="text-align: center;">69%</td> <td style="text-align: center;">10%</td> </tr> </tbody> </table>		Products Containing IEC 62474 Declared Substances	Products Applying for EPEAT or Equivalent Environmental Label	Products Applying for Energy Star	Products Applying the TCO Certificated	Shipment	100%	13%	69%	10%	Assured by SGS
	Products Containing IEC 62474 Declared Substances	Products Applying for EPEAT or Equivalent Environmental Label	Products Applying for Energy Star	Products Applying the TCO Certificated									
Shipment	100%	13%	69%	10%									
TC-HW-410a.3	Percentage of eligible products, by revenue, meeting ENERGY STAR® Criteria	Note 1: The above products include notebook, desktop computers, display products Note 2: EPEAT calculates that the shipments of registered models in each country are taken as the numerator and ENERGY and TCO are based on the number of applied models shipped as the numerator where the denominator is the shipments in 2022	Assured by SGS										
TC-HW-410a.4	Weight of end-of-life products and e-waste recovered, percentage recycled	For related content, please refer to the “Circular Economies and Product Life Cycle” chapter	Assured by SGS										



Code	Accounting Metric	Disclosure Content and Relevant Chapters	External Assurance												
Supply Chain Management															
TC-HW-430a.1	Percentage of Tier 1 supplier facilities audited in the RBA Validated Audit Process (VAP) or equivalent, by (a) all facilities and (b) high-risk facilities	<p>(a) In 2022, we conducted a total of 105 audits. More than 80% of audits were conducted using the RBA Validated Audit Process (VAP). Settlements were audited within the two-year validity period, with an overall implementation rate of 93.7%.</p> <p>(b) For the 2020 RBA audits, 3 companies were listed as higher risk and were to be reviewed again in 2022. The actual number of factory audits was 3. The total audit rate was 100%.</p> <p>For related content, please refer to the “Supply Chain Audit and Improvement” chapter.</p>	Assured by SGS												
TC-HW-430a.2	Tier 1 suppliers' (1) non-conformance rate with the RBA Validated Audit Process (VAP) or equivalent, and (2) associated corrective action rate for (a) priority non-conformances and (b) other non-conformances	<p>(1) Non-Compliance Rates for RBA Code of Conduct Audits</p> <table border="1" style="width: 100%; text-align: center;"> <thead> <tr> <th></th> <th>Labor</th> <th>Health and Safety</th> <th>Environmental</th> <th>Ethics</th> <th>Management System</th> </tr> </thead> <tbody> <tr> <th>Non-conformance rate</th> <td>10.8%</td> <td>5.7%</td> <td>2.7%</td> <td>0.4%</td> <td>1.3%</td> </tr> </tbody> </table> <p>(2) Corrective Action Rate</p> <p>As of the end of 2022, 210 deficiencies have been identified in higher-risk suppliers with VAP audit scores below 160 or priority non-conformance deficiencies, and as of December 31, 2022, 210 deficiencies have been tracked, and improvement measures have been implemented. A total of 15 deficiencies, including priority non-conformances, were listed, and all of them have been listed for corrective action. The other non-conformances have also been listed for corrective action.</p>		Labor	Health and Safety	Environmental	Ethics	Management System	Non-conformance rate	10.8%	5.7%	2.7%	0.4%	1.3%	Assured by SGS
	Labor	Health and Safety	Environmental	Ethics	Management System										
Non-conformance rate	10.8%	5.7%	2.7%	0.4%	1.3%										
Material Sourcing															
TC-HW-440a.1	Description of the management of risks associated with the use of critical materials	According to US National Research Council specifications, tantalum, tungsten, and cobalt are defined as critical raw materials. Management and performance regarding these materials are disclosed in the Responsible Sourcing of Minerals section.	Assured by SGS												

Note 1: We use SASB hardware standards for the technology and communication sector, version 2018-10.

Note 2: With regard to the Sustainability Accounting Standards Table 2 Activity Metrics TC-HW-000.A, TC-HW-000.B and TC-HW-000.C, our description is as follows: Acer's business model is primarily focused around product sales and customer service. In general, we disclose the revenue share of each product in our quarterly institutional investors' conference call. Acer's financial reports and presentations can be found at: <https://www.acer-group.com/ag/en/TW/content/quarterly-reports>



Disclosure of Sustainability Indicators by Listed Companies under the "Rules Governing the Preparation and Filing of Sustainability Reports by TWSE Listed Companies" of the Taiwan Stock Exchange

According to the Taiwan Stock Exchange's "Rules Governing the Preparation and Filing of Sustainability Reports by TWSE Listed Companies", listed companies should strengthen the disclosure of sustainability indicators by industry. Acer is in the computer and related equipment industry and the following are the disclosed indicators. Please refer to Chapter 6, Climate Strategy and Transition for the disclosure of climate related information by listed companies as stipulated in Article 2 of the "Rules Governing the Preparation and Filing of Sustainability Reports by TWSE Listed Companies."

Type / Indicator	Types of Indicator	Annual Disclosure	Units	Remark
I. Total energy consumption, percentage of purchased electricity and renewable energy usage	Quantitative	Total energy consumption: 153,242 GJ % of purchased electricity: 99%	Gigajoules (GJ), percentage	-
II. Total water intake and total water consumption	Quantitative	Total water intake: 162,655 m ³ Total water consumption: 130,124m ³	Thousand cubic meters (m ³)	-
III. Percentage of recovered hazardous waste generated by weight	Quantitative	The main source of waste for Acer is general household waste. No hazardous waste.	Metric tons (t), percentage (%)	-
IV. Explain the type, number and rate of occupational disasters	Quantitative	In 2022, there were 14 occupational accidents at Acer workplaces. Types include: falls, bumps, burns, improper movements, and cuts, slashes, and scratches. For more information on the number and rate of occupational accidents, please refer to the "Acer Global Occupational Injury Statistics 2022" in this report.	Ratio (%), Number	-
V. Disclosure of product lifecycle management, including the weight of end-of-life products and electronic waste and the percentage of recycling	Quantitative	In 2022, Acer has recycled a total of 14,012 tonnes of electronic products in PAP, Pan America, EMEA regions. The rate of recycling is 14.9%.	Metric tons (t), percentage (%)	-
VI. Description of risk management related to the use of critical materials	Qualitative Description	According to the U.S. National Research Council (NRC) Code: Tantalum, tungsten, and cobalt are defined as critical materials, and a description of risk management for these materials is disclosed in the Responsible Mineral Procurement section.	Not applicable	-
VII. Lawsuits related to anti-competitive conduct ordinances	Quantitative	None	Reported Currency	-
VIII. Production of major products by product category	Quantitative	Acer's business model is primarily focused on product sales and customer service. In general, we disclose the revenue share of each product in our quarterly institutional investors' conference call. Financial reports and presentations of Acer are available at: https://www.acer-group.com/ag/zh/TW/content/quarterly-reports	Depending on product type	-



United Nations Global Compact Comparison Table

Category	10 Principles	Report Content/ Explanation	Report Page No.
Human Rights	Businesses should support and respect the protection of internationally proclaimed human rights	Acer supports and respects internationally recognized human rights. Please refer to the “Human Rights Protection” section of this report and the Acer Human Rights Policy.	118
	Make sure that they are not complicit in human rights abuses	Responsible sourcing of minerals is an important ongoing concern for Acer. It is our responsibility to respect human rights and continuously improve the impacts of our business development on human rights. For related actions, please refer to the “Responsible Sourcing of Minerals” section of this report.	78
Labor	Businesses should uphold the freedom of association and the effective recognition of the right to collective bargaining	Acer supports freedom of association and recognizes the right of collective bargaining. For more details, please refer to the “Human Rights Protection” section of this report and the Acer Human Rights Policy.	118
	The elimination of all forms of forced and compulsory labor	Acer prohibits all forms of forced and compulsory labor. For more details, please refer to the “Protecting Human Rights” and “Labor Rights” sections of this report and the Acer Human Rights Policy.	118
	The effective abolition of child labor	Acer prohibits child labor. For more details, please refer to the “Human Rights Protection” and “Labor Rights” sections of this report and the Acer Human Rights Policy.	76,118
	The elimination of discrimination in respect of employment and occupation	Acer does not discriminate in employment or the workplace. For more details, please refer to the “Human Rights Protection” section of this report and the Acer Human Rights Policy.	118,121
Environment	Businesses should support a precautionary approach to environmental challenges	Acer continues to monitor both domestic and international sustainability issues and climate trends. It integrates the potential impacts of climate change into its overall operations and develops specific sustainability policies to mitigate climate risks. For more detailed information and practices, please refer to the “Climate Strategy and Transformation” section in the report.	106
	Undertake initiatives to promote greater environmental responsibility	Acer is committed to reducing the environmental impact of its products during the product life cycle by integrating the concept of circular economy. Acer gives the best effort to reduce the products’ environmental impact, and actively adopts low-carbon recycling strategies such as innovative design, prolonging product life cycle, and effective use of materials to reach a balance between product management and environmental protection. It is also committed to developing products that are beneficial to both the environment and consumers through obtaining patents to protect the R&D results. For details, please refer to the “Circular Economies and Innovation” section of this report.	89
	Encourage the development and diffusion of environmentally friendly technologies	Acer envisions a smart city for a greener and more sustainable future. Its subsidiaries are engaged in various fields of sustainable solutions for everyday living. We work on more eco-friendly innovations and application solutions for smarter cities. For more details, please refer to the “Circular Economies and Innovation” section of this report.	101
Anti-Corruption	Businesses should work against corruption in all its forms, including extortion and bribery	Please refer to the “Zero Tolerance for Corruption” section of this report.	42



| Independent Limited Assurance Report



ASSURANCE STATEMENT

SGS TAIWAN LTD.'S REPORT ON SUSTAINABILITY ACTIVITIES IN THE Acer INC.'s SUSTAINABILITY REPORT FOR 2022

NATURE AND SCOPE OF THE ASSURANCE/VERIFICATION
 SGS Taiwan Ltd. (hereinafter referred to as SGS) was commissioned by Acer Inc. (hereinafter referred to as ACER) to conduct an independent assurance of the Sustainability Report for 2022 (hereinafter referred to as the Report). The scope of the assurance, based on the SGS Sustainability Report Assurance methodology and ISAE 3000 that included the sampled text, and data in accompanying tables, contained in the report presented during verification in the period of 2nd March 2023 to 1st April 2023. SGS reserves the right to update the assurance statement from time to time depending on the level of report content discrepancy of the published version from the agreed standards requirements.

INTENDED USERS OF THIS ASSURANCE STATEMENT
 This Assurance Statement is provided with the intention of informing all ACER's Stakeholders.

RESPONSIBILITIES
 The information in the ACER's Sustainability Report of 2022 and its presentation are the responsibility of the directors or governing body (as applicable) and management of ACER. SGS has not been involved in the preparation of any of the material included in the Report.

Our responsibility is to express an opinion on the report content within the scope of verification with the intention to inform all ACER's stakeholders.

ASSURANCE STANDARDS, TYPE AND LEVEL OF ASSURANCE
 The SGS ESG & Sustainability Report Assurance protocols used to conduct assurance are based upon internationally recognized assurance guidance and standards including the principles of reporting process contained within the Global Reporting Initiative Sustainability Reporting Standards (GRI Standards) GRI 1: Foundation 2021 for report quality, GRI 2 General Disclosure 2021 for organisation's reporting practices and other organizational detail, GRI 3 2021 for organisation's process of determining material topics, its list of material topics and how to manages each topic, and the guidance on levels of assurance contained within the AA1000 series of standards and/or ISAE3000.

The assurance of this report has been conducted according to the following Assurance Standards:

Assurance Standard Options	Level of Assurance
A	SGS ESG & SRA Assurance Protocols (based on GRI Principles and guidance in AA1000)
B	ISAE 3000 Limited Level

TWLPP 5008 Issue 2305

SCOPE OF ASSURANCE AND REPORTING CRITERIA
 The scope of the assurance included evaluation of adherence to the following reporting criteria:

Reporting Criteria Options	
1	GRI Universal Standard (2021) (In Accordance with)
2	SASB- Hardware (Version 2018-10)

- evaluation of content veracity of the sustainability performance information in relation to the determined material topics at a limited level of scrutiny for ACER and limited level of scrutiny for subsidiaries and applicable aspect boundaries outside of the organization covered by this report;
- evaluation of the report against the requirements of Global Reporting Initiative Universal Standard 2021 (GRI 2, GRI 3, GRI 200, 300 and 400 series which identified its economic, environment, and social aspect as material topics and disclosure) claimed in the GRI content index as material and in accordance with.
- evaluate of the report against the SASB Disclosures and Metrics included in the Hardware of Sustainability Accounting Standard (VERSION 2018-10) and conducted alongside an evaluation of accuracy assurance at moderate level of scrutiny.

SPECIFIED PERFORMANCE INFORMATION AND DISCLOSURES INCLUDED IN SCOPE
 ACER's Sustainability Report content including its Environment, Social and Governance performance are adequately in line with GRI Standard and SASB Disclosures and Metrics of Hardware (Version 2018-10) as listed in ACER's Sustainability report of 2022 of GRI Standards Index and SASB Index.

ASSURANCE METHODOLOGY
 The assurance comprised a combination of pre-assurance research, interviews with relevant employees, superintendents, Sustainability committee members and the senior management in Taiwan; documentation and record review and validation with external bodies and/or stakeholders where relevant.

LIMITATIONS AND MITIGATION
 Financial data drawn directly from independently audited financial accounts, Task Force on Climate-related Financial Disclosures (TCFD) has not been checked back to source as part of this assurance process.

STATEMENT OF INDEPENDENCE AND COMPETENCE
 The SGS Group of companies is the world leader in inspection, testing and verification, operating in more than 140 countries and providing services including management systems and service certification; quality, environmental, social and ethical auditing and training; environmental, social and sustainability report assurance. SGS affirm our independence from ACER, being free from bias and conflicts of interest with the organisation, its subsidiaries and stakeholders.

The assurance team was assembled based on their knowledge, experience and qualifications for this assignment, and comprised auditors registered with ISO 26000, ISO 20121, ISO 50001, SA8000, RBA, QMS, EMS, SMS, GPMS, CFP, WFP, GHG Verification and GHG Validation Lead Auditors and experience on the SRA Assurance service provisions.

FINDINGS AND CONCLUSIONS

ASSURANCE/VERIFICATION OPINION

TWLPP5008 Issue 2305

ISAE3000

On the basis of the methodology described and the verification work performed, we are satisfied that the disclosure with inclusivity, materiality, responsiveness, and impact information in the scope of assurance is reliable, has been fairly stated and has been prepared, in all material respects, in accordance with the reporting criteria.

We believe that the organisation has chosen an appropriate level of assurance for this stage in their reporting.

GLOBAL REPORTING INITIATIVE REPORTING STANDARDS CONCLUSIONS, FINDINGS AND RECOMMENDATIONS

The report, ACER's Sustainability Report of 2022, is adequately in accordance with the GRI Universal Standards 2021 and complies with the requirements set out in section 3 of GRI 1 Foundation 2021, where the significant impacts on the economy, environment, and people, including impacts on their human rights are assessed and disclosed following the guidance defined in GRI 3: Material Topic 2021, and the relevant 200/300/400 series Topic Standard related to Material Topic have been disclosed. The report has properly disclosed information related to ACER's contributions to sustainability development. For future reporting, ACER is encouraged to prepare for the transition to reporting in accordance with the GRI Standards, with more comprehensive details of its management processes on the identified impacts on the economy, environment, and people, including impacts on their human rights.

SASB

Acer has referenced with SASB's Standard, TECHNOLOGY & COMMUNICATIONS SECTOR- HARDWARE INDUSTRY STANDARD, VERSION 2018-10 to disclose information of material topics that are vital for enterprise value creation. The reporting boundary is the same as Acer's sustainability report. Acer used SASB accounting and activity metrics to assess and manage the topic-related risks and opportunities, where relevant quantitative information was assessed for its accuracy and completeness to support the comparability of the data reported. Acer has determined which disclosure topics and associated metrics are financially material to its business and has illustrated appropriately in the content index. By using both GRI and SASB standards together, the efficiency of communication and the identification of material issues are substantially increased during the whole reporting preparation process.

Signed:
 For and on behalf of SGS Taiwan Ltd.



Stephen Pao
 Knowledge Deputy General Manager
 Taipei, Taiwan
 20 June, 2023
www.sgs.com

TWLPP5008 Issue 2305